

Laird

TECHNOLOGIES®



global solutions :
local support.

| Board Level Shields
and Contacts

Laird

TECHNOLOGIES®



Laird Technologies is the world-leader in the design and supply of customized performance-critical products for wireless and other advanced electronic applications. Laird Technologies partners with its customers to help find solutions for applications in various industries such as:

- Network Equipment
- Telecommunications
- Data Communications
- Automotive Electronics
- Computers
- Aerospace
- Military
- Medical Equipment
- Consumer Electronics

Laird Technologies offers its customers unique product solutions, dedication to research and development and a seamless network of manufacturing and customer support facilities located all across the globe.

global solutions :
local support™

TABLE OF CONTENTS

INTRODUCTION TO BOARD LEVEL SHIELDS AND CONTACTS

Board Level Shields and Contacts.	2
Design Engineering	2
Prototyped Parts	2
Packaging Automation	2
Quality ISO 9001:2000 Certified	2
RoHS Statement	2

STANDARD DESIGN SHIELDS AND CONTACTS

97-2000 Shields (Series 97-2000)	3
Printed Circuit Board Shields (Series 97-860, 866, 870)	5
Standard Surface Mount Shields One-Piece and Two-Piece.	6
Part No. BMIS-101 and 201	7
Part No. BMIS-102 and 202	8
Part No. BMIS-103 and 203	9
Part No. BMIS-104 and 204	10
Part No. BMIS-105 and 205	11
Part No. BMIS-106 and 206	12
Part No. BMIS-107 and 207	13
Part No. BMIS-208	14
Part No. BMIS-209	14
Part No. BMIS-210	15
EZ Peel™ Standard Shields	16
Part No. 97-2002	17
Part No. 97-2003	17
Part No. 97-2004	17
Part No. 97-2005	17
Standard Precision Electronic Contacts	18
Part No. BMIC-001	18
Part No. BMIC-002	18
Part No. BMIC-004	18
Part No. BMIC-006	19
Part No. BMIC-007-01.	19
Part No. BMI-C-010-*	19

CUSTOM DESIGN SHIELDS AND CONTACTS

Introduction.	20
One-Piece Shield Design	20
Two-Piece Shield Design	20
EZ Peel™ Shield Design.	21
Multi-Compartmental Shield Design	21
Drawn Board Level Shields (Series 97-2100)	21
Custom Precision Electronic Contacts	22

Products/specifications are subject to change. Please contact Laird Technologies for potential changes in product specifications.

BOARD LEVEL SHIELDS AND CONTACTS

Laird Technologies one-piece shields, multi-compartmental shields and precision contacts are designed to maximize performance in a minimum timeframe. Metal electronic components are packaged for surface mount applications suitable for a variety of industries. Laird Technologies expertise is in numerous key divisions to ensure each part optimizes individual applications. Here's how we help you succeed:

DESIGN ENGINEERING

Before contacting a Laird Technologies engineer, determine the right board level shield or contact design for the application. Based upon specifications, Laird Technologies experts will use the latest Pro-Engineering/AutoCAD systems to develop part designs in hours. Drawing upon extensive experience with application engineering, advanced design and materials engineering, Laird Technologies engineers will solve the most complex board level shield and contact problems.

Laird Technologies engineers and technical specialists look beyond the initial component to the entire application. Each engineer will create the ideal finished product at the best value. Example considerations include board layout, EMI shielding requirements and grounding terminations.

FAST TURNAROUND ON PROTOTYPES

Accuracy and speed in the prototyping process are crucial in creating a successful product. Laird Technologies staff quickly responds within days with a prototyped part. By manufacturing with precision, the prototype meets the tolerances of a progressive die manufacturing production environment.

If design modifications are necessary, Laird Technologies prototype department is flexible and will address changes without affecting the delivery of the prototyped part. To ensure parts are delivered at optimum performance and meet specifications, all prototyped parts are 100% inspected on critical dimensions.

Laird Technologies also provides pre-production support to help get the production line up and running quickly. Parts designed in pre-production can be supplied while progressive die tools are being produced.

With manufacturing plants throughout North America, Asia and Europe Laird Technologies provides worldwide access to parts and offers the capacity to handle any size job.

PACKAGING AUTOMATION

For innovations in packaging and in shield assemblies, a dedicated in-house automation engineering department routinely develops new automation technologies. An array of packaging options is available for shields and contacts, including tape and reel, tray, tube and bulk. Laird Technologies tape and reel packaging allows for the lowest installed cost and is Electronic Industries Association (EIA) 481 compliant. Tape sizes are supplied on 13-inch and 15-inch diameter reels. A transparent cover tape allows component verification and inspection without having to remove or handle components.

Two-piece shields, including multi-compartmental shields, are packaged as either assembled or unassembled parts.

Laird Technologies innovative automation engineering allows engineers to design small and complex contacts requiring pick-up zones of 1 mm and weighing less than 0.01 grams. Custom automation equipment places the miniature contacts into tape pockets quickly and cost effectively. The tape and reel packaged parts are ready for installation onto printed circuit boards using standard pick-and-place equipment.

Vision recognition marks, such as holes and tabs, can orient parts. This eliminates an added step and leads to faster production. Laird Technologies ensures each design has an adequate pick-up area for pick-and-place equipment, without sacrificing performance.

QUALITY-ISO 9001:2000 CERTIFIED

By placing a premium on quality, Laird Technologies has received the highest ratings on major customer qualification audits. Customers continually rank Laird Technologies among one of the top suppliers for quality and performance. The board level shield and contact facilities are ISO 9001:2000 certified by TUV-America Inc.

Built-in quality systems, including Laird Technologies proprietary 100% automated co-planarity inspection for board level shields, ensures rigid standards are met through all stages of operations (design, production, shipping, as well as prompt customer concern resolution).

Laird Technologies executes real-time, automated SPC on all critical dimensions throughout production. By taking these measurements, quality assurance technicians can make necessary adjustments on the spot to ensure quality parts are on schedule. Maintaining traceability with SPC results for all jobs; captured data includes operator, shift, raw material, job number, work center and more. Additionally, non-contact, automated coordinate measuring machines (CMM) are located throughout Laird Technologies factory floors.

RoHS Statement

All products in this catalog, along with all other Board Level Shield products are compliant to the RoHS standards.



97-2000 SHIELDS Range of Pin and Pad Mounting Styles Maximizes Flexibility

The 97-2000 series allows mounting options including various pin styles for through-hole mounting or pad styles for surface mounting. The frame material forms the walls of the enclosure and the cover is held securely in place by spring force alone. Covers can be easily removed and replaced to provide access to components. Large or small quantities are easily manufactured using automated tooling, short run capabilities or photochemical machining operations.

- 97-2000 frame heights from 0.130" (3,0 mm) to 1" (25,4 mm), with other heights available upon request
- Cover design permits retention even when severe shock or vibration are a consideration; cover designed for easy removal and replacement
- Design allows for automated pick-and-place operations
- Locking feature on frame guarantees corner joint stability
- Variety of pin style options available including a surface mountable style
- Pin location can be customized to hole location or a defined pitch
- Frames can be hand-formed or supplied formed and with cover assembled
- A modified pin style is available for extra retention in through hole application
- All parts are treated as custom, so standards exist
- RoHS compliant

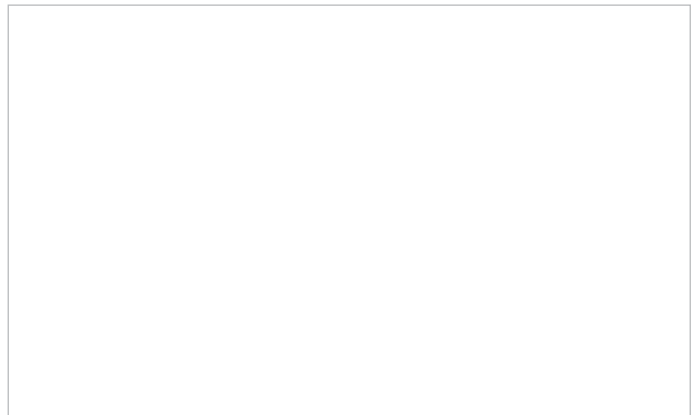
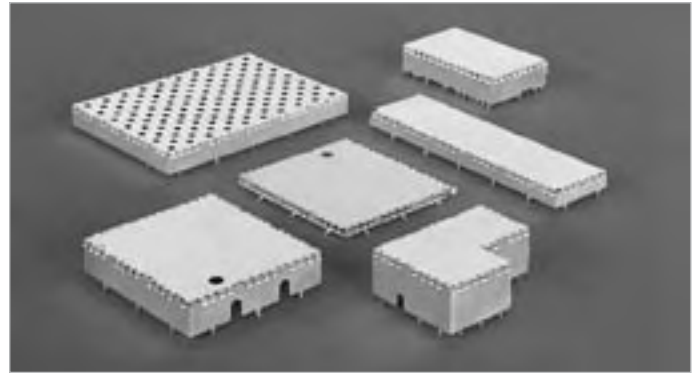

▲ Test performance in accordance with MIL-STD-285 using an aperture the same size as the 1-3/4" x 2" (44,5 mm x 5,08 mm) PC shield as reference. Measurement below 400 MHz were not possible because of the aperture attenuation.

97-2000 SHIELDS Frame Height and Pin Option

PIN STYLE 1.

Through Hole with Standoff
.130 to 1.000 (3,3 to 25,4) Under Cover Height Range

FIGURE 1.

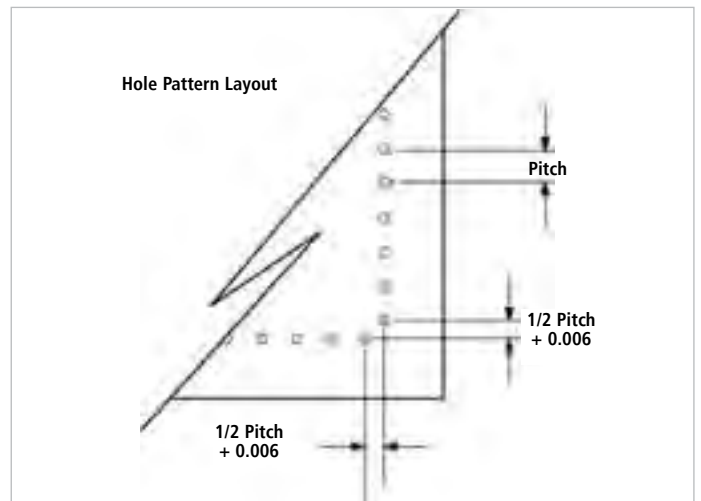

(Consult engineering for irregular hole patterns.)



STANDARD DESIGN SHIELDS AND CONTACTS

PIN STYLE 2.

Surface Mount Tab

.130 to 1.000
(3,3 to 25,4)
Under Cover
Height Range

FIGURE 2.

Pitch Selection Placement and Corner Locking Feature

.130 to 1.000
(3,3 to 25,4)
Under Cover
Height Range

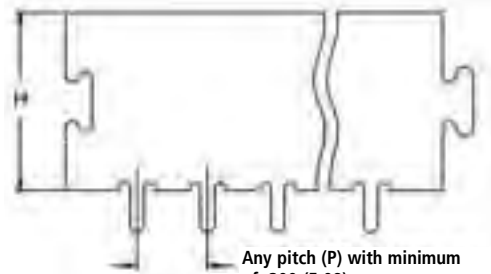

Any pitch (P) with minimum
of .200 (5,08)

PIN STYLE 3.

Through Hole

.130 to 1.000
(3,3 to 25,4)
Under Cover
Height Range

FIGURE 3.

Cover Detail Standard cover material thickness 0.010" (0,25 mm) tin plated phosphor bronze, in coated steel or stainless steel

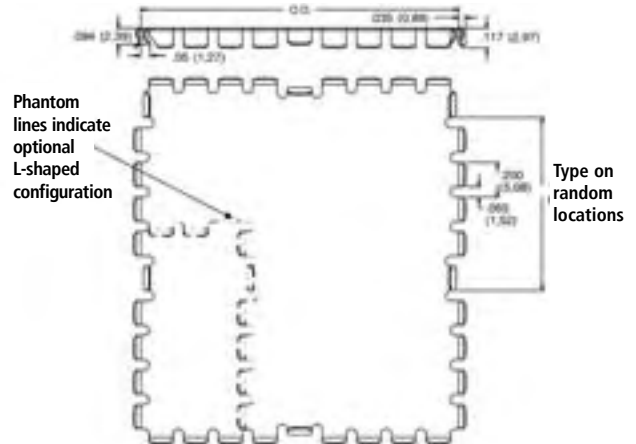

Phantom
lines indicate
optional
L-shaped
configuration

Type on
random
locations

PIN STYLE 4.

Flush Surface Mount

.130 to 1.000
(3,3 to 25,4)
Under Cover
Height Range

All dimensions shown are in inches (millimeters) unless otherwise specified.



High-Performance, Readily Available

Laird Technologies standard board level shields and contacts offer readily available, low-cost EMI shield and contact alternatives to custom designed solutions. A variety of sizes and designs are available to choose from, so finding a product that delivers the desired results for a project is easy. Modifications are an option if the standard product does not fully fit space requirement constraints.

Laird Technologies standard shields and contacts are available in a range of material choices, and all allow for full solderability. Standard shield offerings incorporate proprietary design criteria for maximum performance and are available in one-piece and two-piece designs. Laird Technologies standard contacts base materials include beryllium copper, phosphor bronze, nickel and stainless steel. Many plating options are offered for maximum electrical current carrying performance.

PC SHIELD DIMENSIONS

SERIES	A	B	C	D	E	APPROX. LENGTH FT (M)
97-860	.520 (13,2)	.045 (1,1)	.120 (3,2)	.030 (0,8)	.400 (10,2)	25 (7,6)
97-866	.820 (20,8)	.045 (1,1)	.120 (3,2)	.030 (0,8)	.700 (17,8)	25 (7,6)
97-870	1.120 (28,4)	.045 (1,1)	.120 (3,2)	.030 (0,8)	1.00 (25,4)	25 (7,6)

Other heights and custom-designed cover configurations available. Consult sales department.

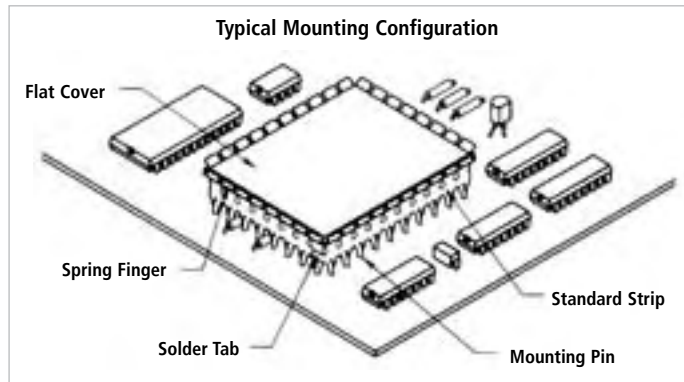

PRINTED CIRCUIT BOARD SHIELDS

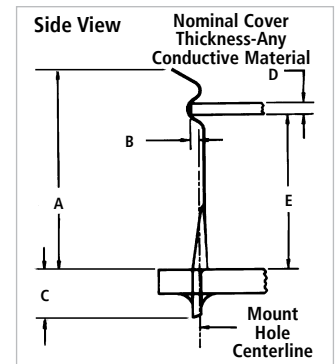
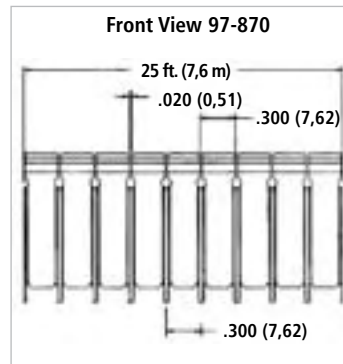
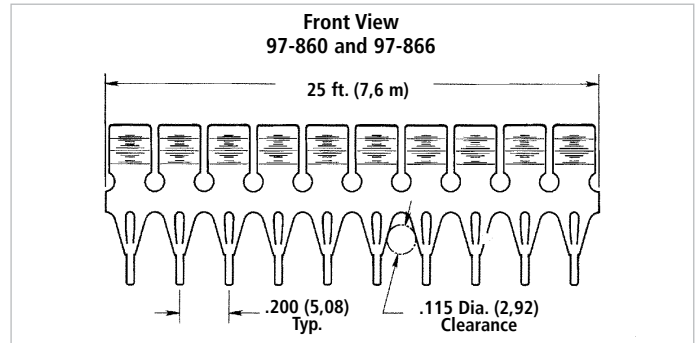
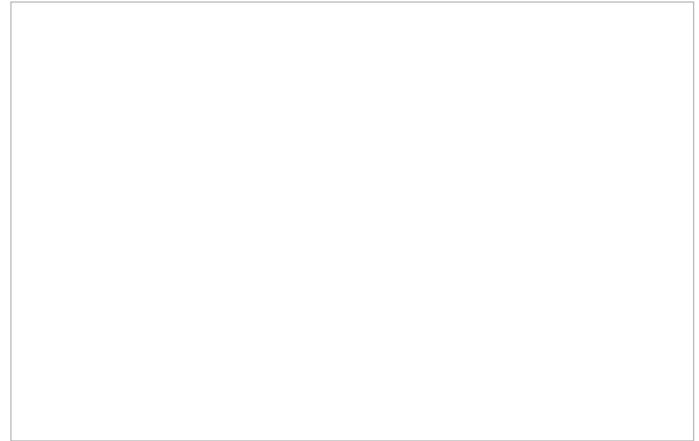

All dimensions shown are in inches (millimeters) unless otherwise specified.



STANDARD SURFACE MOUNT SHIELDS ONE-PIECE

Off the Shelf, On Spec and On Budget

One-piece standard surface mount shields offer six sides of protection, with the sixth side being the board itself. One-piece designs offer economical shielding protection where access to covered components is not necessary. There are no tooling costs associated with either the one and/or two-piece design.

STANDARD SURFACE MOUNT SHIELDS TWO-PIECE

Reduce Board Damage From Inspection and Repairs

Two-piece standard surface mount shields offer users the flexibility to inspect or repair shielded components without risking board damage by removing the entire shield or incurring tooling costs. Covers snap on and off with ease, which makes repair of the component under the shield quicker and easier and reduces board re-work. Two-piece shields are available unassembled* and are designed to survive drop, shock and no-rattle tests.

*Pre-assembly is an option. Consult sales.

STANDARD ONE-PIECE BOARD LEVEL SHIELDS

PART NUMBER	MAXIMUM OVERALL LENGTH	MAXIMUM OVERALL WIDTH	MAXIMUM OVERALL HEIGHT	CARRIER TAPE WIDTH	CARRIER TAPE PITCH	PARTS PER REEL	WEIGHT
BMI-S-101	.538 (13,66)	.476 (12,10)	.100 (2,54)	24 mm	20 mm	1000	0.4 g
BMI-S-102	.650 (16,50)	.650 (16,50)	.142 (3,60)	32 mm	24 mm	700	0.7 g
BMI-S-103	1.032 (26,21)	1.032 (26,21)	.200 (5,08)	44 mm	32 mm	300	1.6 g
BMI-S-104	1.260 (32,00)	1.260 (32,00)	.236 (6,00)	44 mm	36 mm	225	2.4 g
BMI-S-106	1.450 (36,83)	1.326 (33,68)	.200 (5,08)	56 mm	40 mm	300	2.4 g
BMI-S-105	1.500 (38,10)	1.000 (25,40)	.236 (6,00)	56 mm	32 mm	250	2.5 g
BMI-S-107	1.747 (44,37)	1.747 (44,37)	.384 (9,75)	56 mm	56 mm	120	6.5 g

STANDARD TWO-PIECE BOARD LEVEL SHIELD FRAMES

PART NUMBER	OVERALL LENGTH	OVERALL WIDTH	OVERALL HEIGHT	TAPE WIDTH	TAPE PITCH	PARTS PER REEL
BMI-S-201-F	.538 (13,66)	.476 (12,10)	.100 (2,54)	24 mm	20 mm	1000
BMI-S-202-F	.650 (16,50)	.650 (16,50)	.142 (3,60)	32 mm	24 mm	700
BMI-S-203-F	1.032 (26,21)	1.032 (26,21)	.200 (5,08)	44 mm	32 mm	300
BMI-S-209-F	1.156 (29,36)	.728 (32,00)	.275 (7,00)	56 mm	28 mm	400
BMI-S-204-F	1.260 (32,00)	1.260 (32,00)	.236 (6,00)	44 mm	36 mm	225
BMI-S-206-F	1.450 (36,83)	1.326 (33,68)	.200 (5,08)	56 mm	40 mm	300
BMI-S-205-F	1.500 (38,10)	1.000 (25,40)	.236 (6,00)	56 mm	44 mm	250
BMI-S-210-F	1.732 (44,02)	1.201 (30,50)	.118 (3,00)	56 mm	40 mm	450
BMI-S-207-F	1.747 (44,37)	1.747 (44,37)	.384 (9,75)	56 mm	56 mm	120
BMI-S-208-F	1.559 (39,60)	1.559 (39,60)	.276 (7,00)	56 mm	48 mm	200

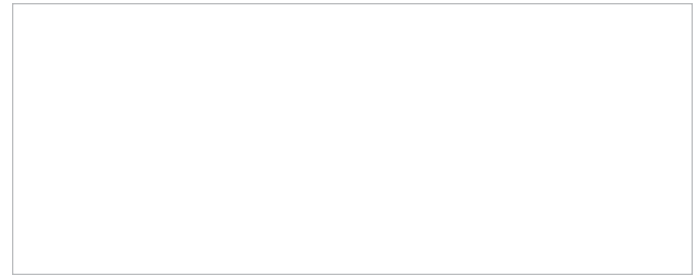
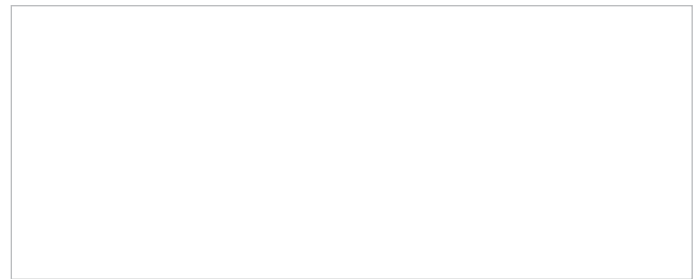

TYPICAL PROPERTIES & PERFORMANCE - ALL PART NUMBERS

PROPERTY	TEST METHOD	RESULT
Co-planarity	LTWI-1119	<0,10 mm
Solderability	ANSI/JSTD-002	>99%
Solderability	MIL-STD-202 Method 208	>99%
Adhesion	ASTM B-571	Passes
3 Axis Mechanical Shock	LTES-461	Passes

DESIGN PARAMETERS - ALL PART NUMBERS

PICK-UP SPOT DIAMETER	MATERIAL	MATERIAL THICKNESS	CARRIER TAPE MATERIAL
6 mm or greater	0,20 mm CRS Tin	0,20 mm	LTIMS-LCB
Cover tape material	REEL DIAMETER	REEL MATERIAL	PACKAGING
LTIMS-PSA	330 mm (101, 102, 103, 104, 201 202 203 204) 381 mm (105, 106, 107, 205, 206, 207, 208, 209, 210)	Plastic	EIA-481

All dimensions shown are in inches (millimeters) unless otherwise specified.



STANDARD SURFACE MOUNT SHIELD ONE-PIECE

DESIGN SPECIFICATIONS

PART NUMBER	MAXIMUM OVERALL DIMENSION	MAXIMUM OVERALL HEIGHT	CARRIER TAPE WIDTH	CARRIER TAPE PITCH	PARTS PER REEL
BMI-S-101	.538 x .476 (13,66 x 12,70)	.100 (2,54)	24 mm	20 mm	1000

Dimensions (mm)

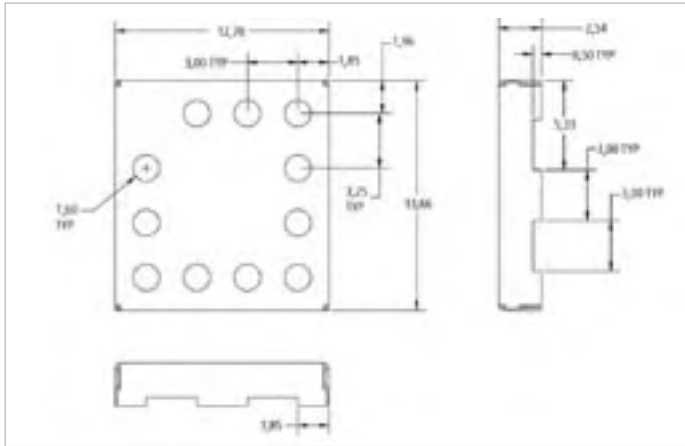

APPLICATIONS:

- Works exceptionally well in small component areas
- 48 VQFP

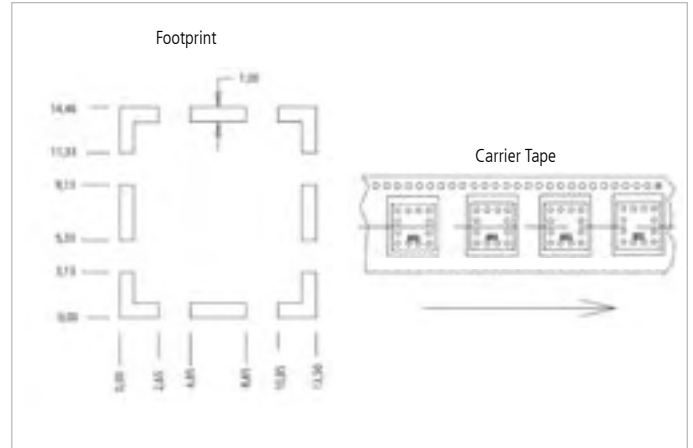

STANDARD SURFACE MOUNT SHIELD TWO-PIECE

DESIGN SPECIFICATIONS

PART NUMBER	MAXIMUM OVERALL DIMENSION	MAXIMUM OVERALL HEIGHT	CARRIER TAPE WIDTH	CARRIER TAPE PITCH	PARTS PER REEL
BMI-S-201-F	.538 x .476 (13,66 x 12,70)	.100 (2,54)	24 mm	20 mm	1000

The cover is ordered as a separate part. The part number is BMI-S-201-C and is packaged in the same quantity as the frame.

Dimensions (mm)

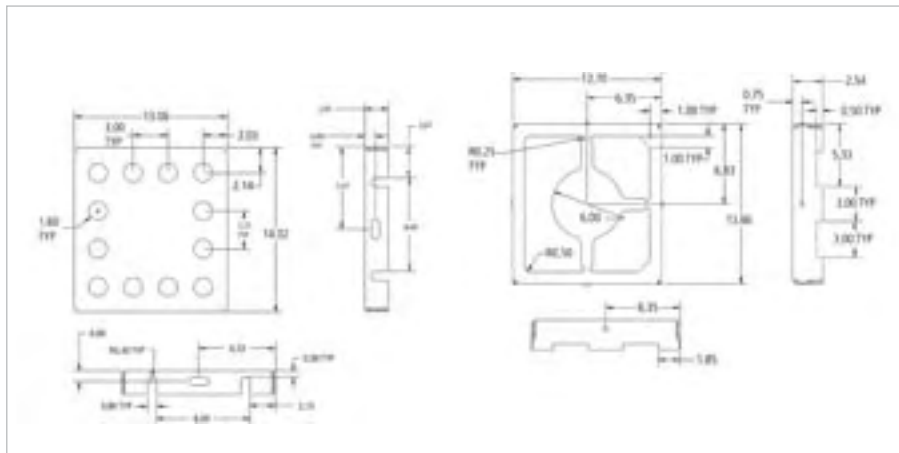

APPLICATIONS:

- Works exceptionally well in small component areas
- 48 VQFP

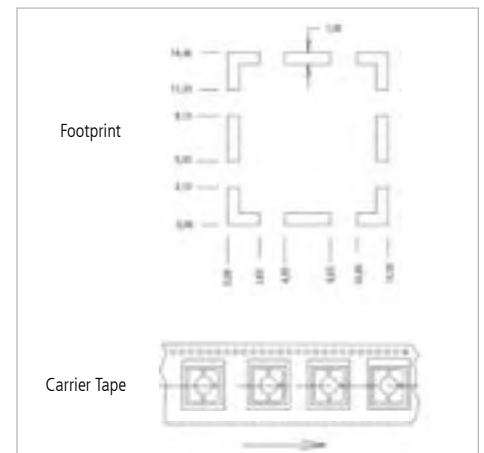
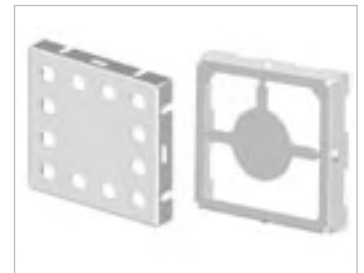



STANDARD SURFACE MOUNT SHIELD ONE-PIECE PART NO. BMI-S-102

DESIGN SPECIFICATIONS

PART NUMBER	MAXIMUM OVERALL DIMENSION	MAXIMUM OVERALL HEIGHT	CARRIER TAPE WIDTH	CARRIER TAPE PITCH	PARTS PER REEL
BMI-S-102	.650 x .650 (16,50 x 16,50)	.142 (3,60)	32 mm	24 mm	700

APPLICATIONS:

- 48 VQFP
- 44, 48 QFP

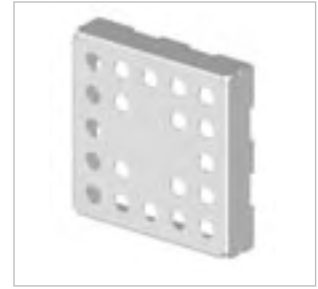

Dimensions (mm)

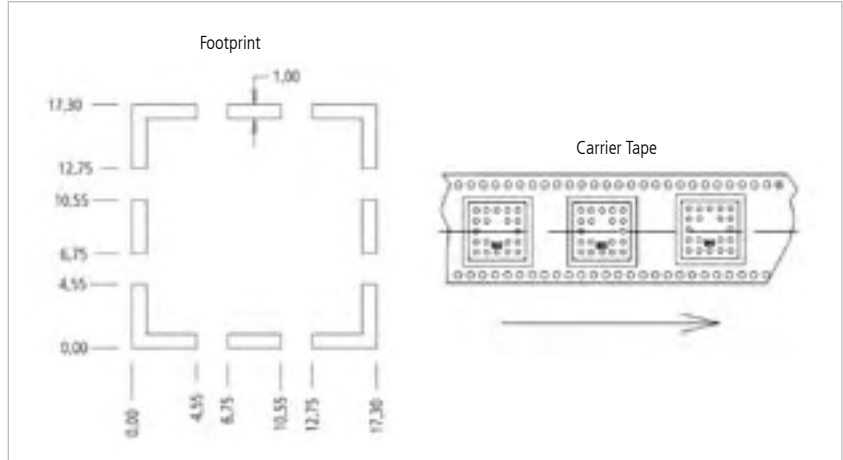
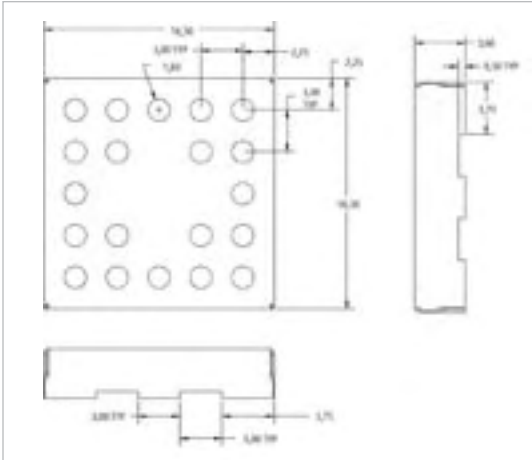

STANDARD SURFACE MOUNT SHIELD TWO-PIECE PART NO. BMI-S-202

DESIGN SPECIFICATIONS

PART NUMBER	MAXIMUM OVERALL DIMENSION	MAXIMUM OVERALL HEIGHT	CARRIER TAPE WIDTH	CARRIER TAPE PITCH	PARTS PER REEL
BMI-S-202-F	.650 x .650 (16,50 x 16,50)	.142 (3,60)	32 mm	24 mm	700

APPLICATIONS:

- 48 VQFP
- 44, 48 QFP

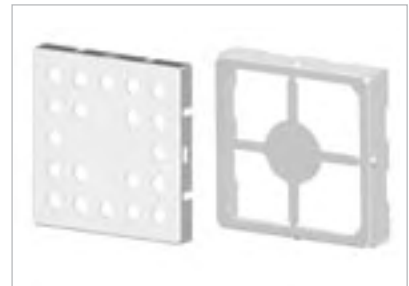

The cover is ordered as a separate part. The part number is BMI-S-202-C and is packaged in the same quantity as the frame.

Dimensions (mm)

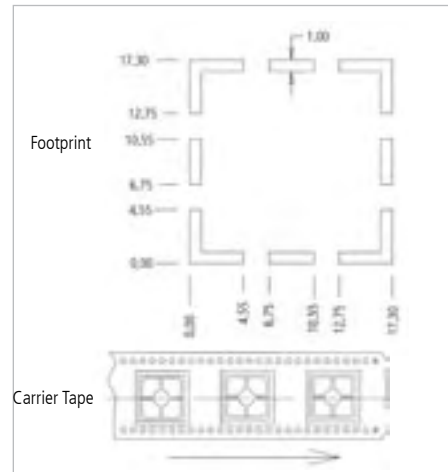
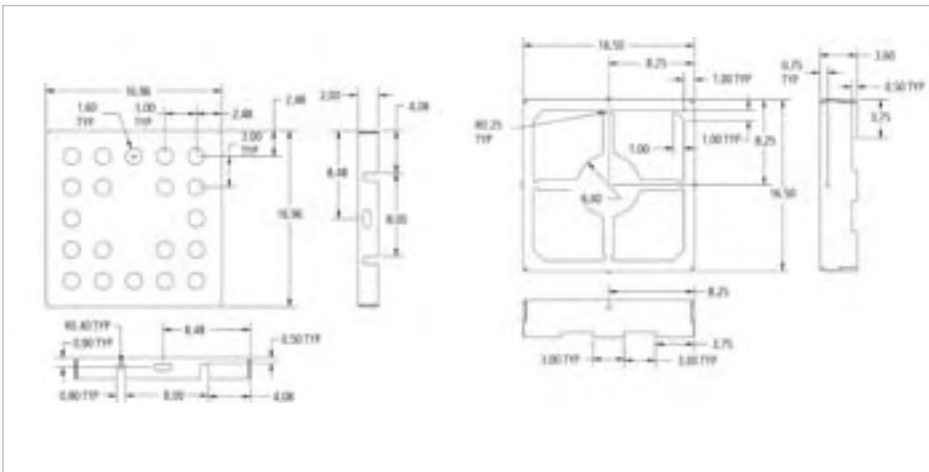



STANDARD SURFACE MOUNT SHIELD ONE-PIECE

DESIGN SPECIFICATIONS

PART NUMBER	MAXIMUM OVERALL DIMENSION	MAXIMUM OVERALL HEIGHT	CARRIER TAPE WIDTH	CARRIER TAPE PITCH	PARTS PER REEL
BMI-S-103	1,032 x 1,032 (26,21 x 26,21)	.200 (5,08)	44 mm	32 mm	300

APPLICATIONS:

- 32, 44, 52 pin PLCC
- 121, 169 BGA
- 48, 100 VQFP
- 44, 48, 64, 80 QFP

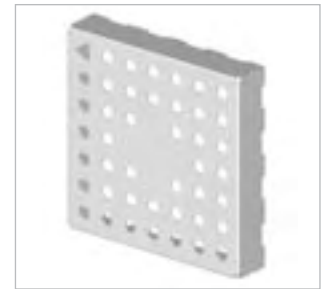

Dimensions (mm)

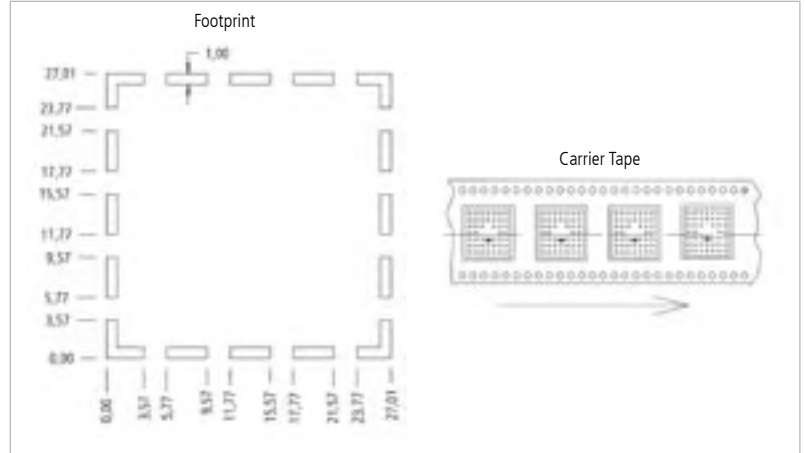
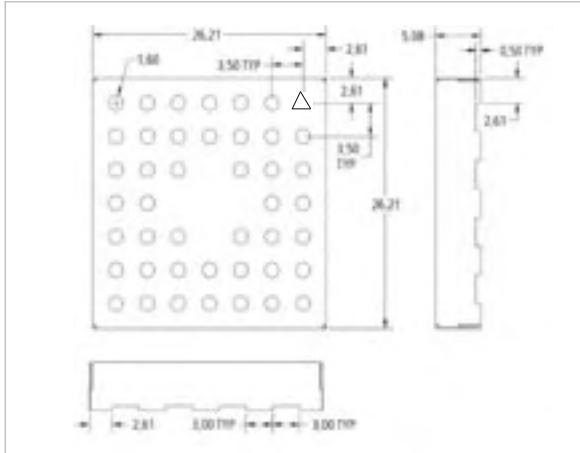

STANDARD SURFACE MOUNT SHIELD TWO-PIECE

DESIGN SPECIFICATIONS

PART NUMBER	MAXIMUM OVERALL DIMENSION	MAXIMUM OVERALL HEIGHT	CARRIER TAPE WIDTH	CARRIER TAPE PITCH	PARTS PER REEL
BMI-S-203-F	1,032 x 1,032 (26,21 x 26,21)	.200 (5,08)	44 mm	32 mm	300

APPLICATIONS:

- 32, 44, 52 pin PLCC
- 121, 169 BGA
- 48, 100 VQFP
- 44, 48, 64, 80 QFP

The cover is ordered as a separate part. The part number is BMI-S-203-C and is packaged in the same quantity as the frame.

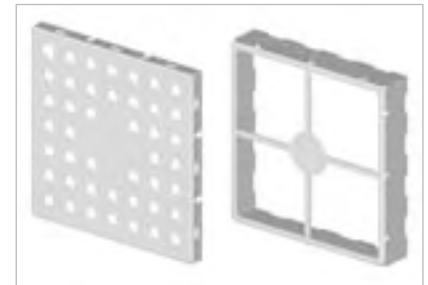

Dimensions (mm)

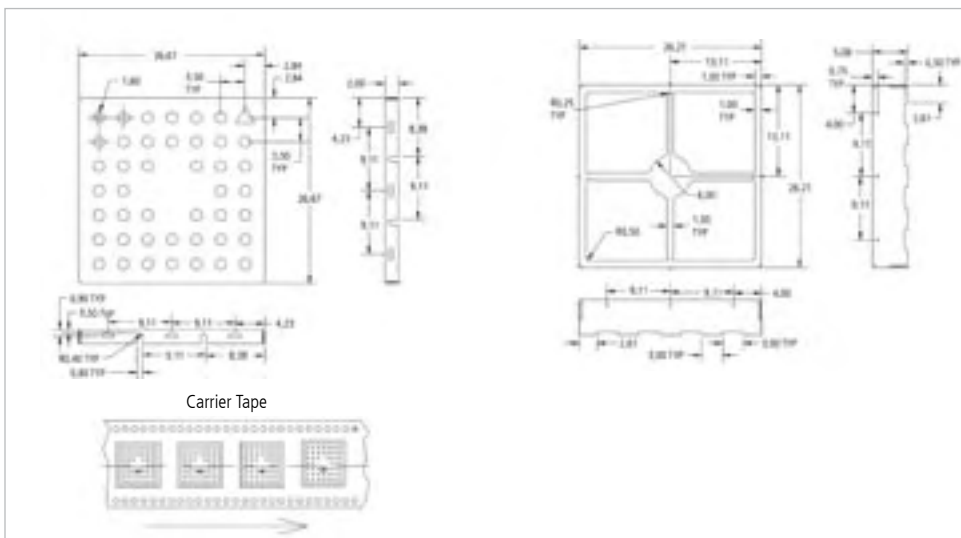

Footprint

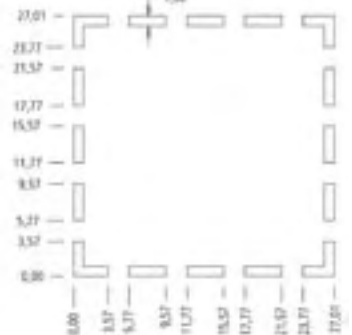



STANDARD DESIGN SHIELDS AND CONTACTS

STANDARD SURFACE MOUNT SHIELD ONE-PIECE

DESIGN SPECIFICATIONS

PART NUMBER	MAXIMUM OVERALL DIMENSION	MAXIMUM OVERALL HEIGHT	CARRIER TAPE WIDTH	CARRIER TAPE PITCH	PARTS PER REEL
BMI-S-104	1,260 x 1,260 (32,00 x 32,00)	,236 (6,00)	44 mm	36 mm	225

APPLICATIONS:

- 121, 169, 225 BGA
- 32, 44, 52, 68 PLCC
- 48, 100 VQFP
- 44, 48, 64, 80, 100 QFP

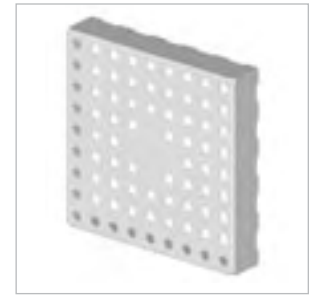

Dimensions (mm)

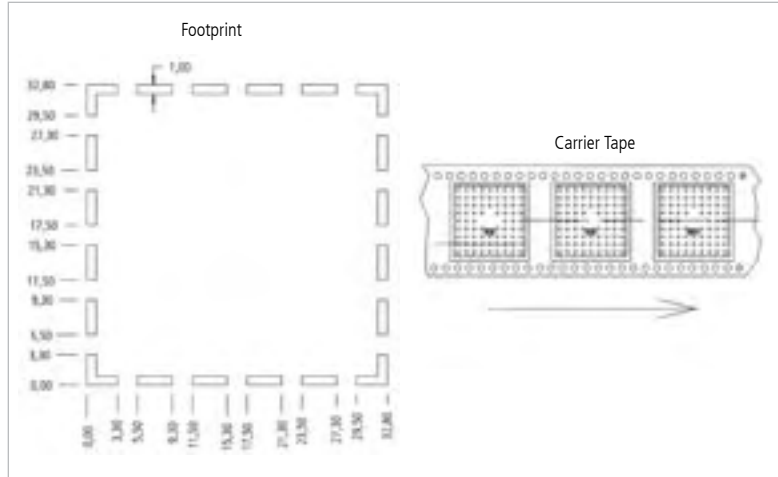
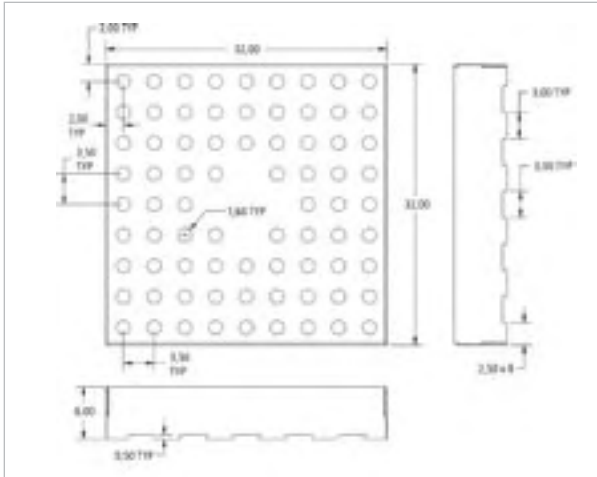

STANDARD SURFACE MOUNT SHIELD TWO-PIECE

DESIGN SPECIFICATIONS

PART NUMBER	MAXIMUM OVERALL DIMENSION	MAXIMUM OVERALL HEIGHT	CARRIER TAPE WIDTH	CARRIER TAPE PITCH	PARTS PER REEL
BMI-S-204-F	1,260 x 1,260 (32,00 x 32,00)	,236 (6,00)	44 mm	36 mm	225

APPLICATIONS:

- 121, 169, 225 BGA
- 32, 44, 52, 68 PLCC
- 48, 100 VQFP
- 44, 48, 64, 80, 100 QFP

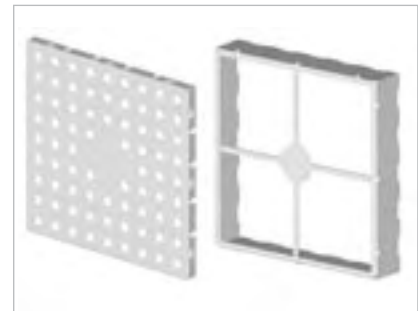

The cover is ordered as a separate part. The part number is BMI-S-204-C and is packaged in the same quantity as the frame.

Dimensions (mm)

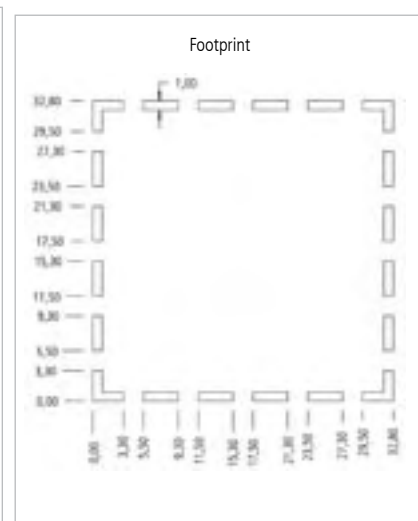
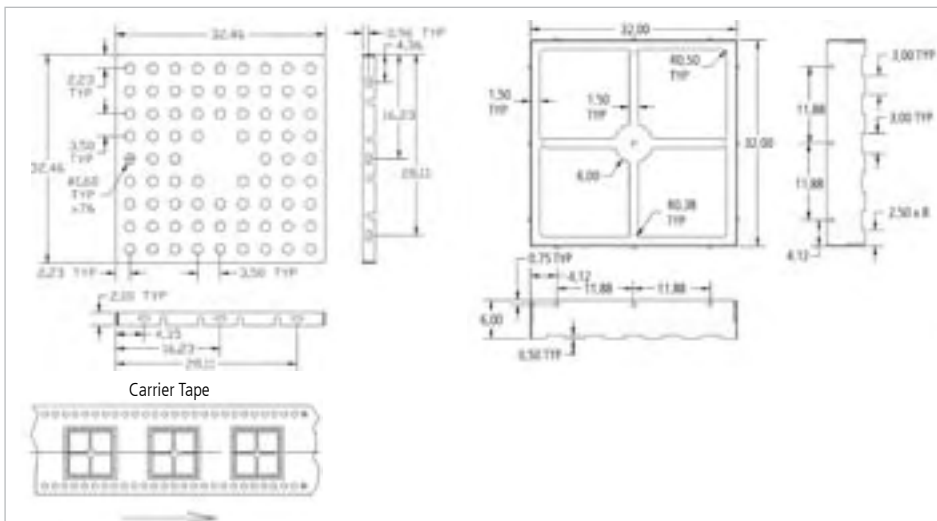



STANDARD SURFACE MOUNT SHIELD ONE-PIECE

DESIGN SPECIFICATIONS

PART NUMBER	MAXIMUM OVERALL DIMENSION	MAXIMUM OVERALL HEIGHT	CARRIER TAPE WIDTH	CARRIER TAPE PITCH	PARTS PER REEL
BMI-S-105	1,500 x 1,000 (38,10 x 25,40)	.236 (6,00)	56 mm	32 mm	250

APPLICATIONS:

- 121 BGA
- 32, 44, 52 PLCC
- 48, 100 VQFP
- 44, 48, 64, 80, 100 QFP



Dimensions (mm)

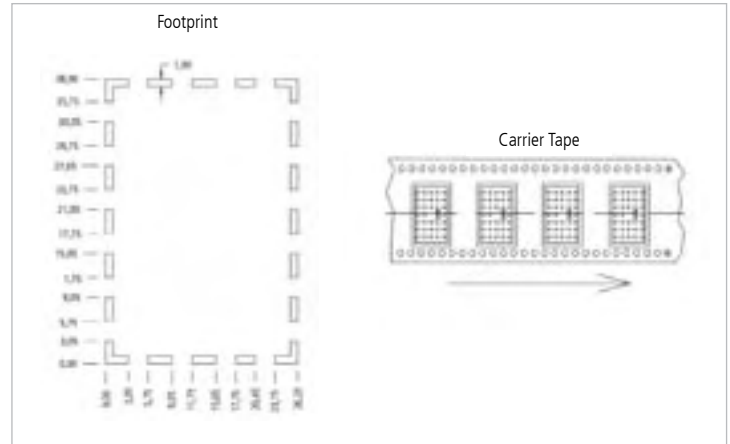
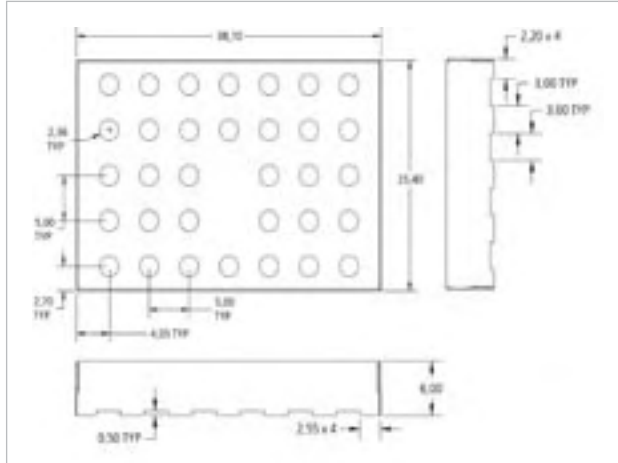

STANDARD SURFACE MOUNT SHIELD TWO-PIECE PART NO. BMI-S-205

DESIGN SPECIFICATIONS

PART NUMBER	MAXIMUM OVERALL DIMENSION	MAXIMUM OVERALL HEIGHT	CARRIER TAPE WIDTH	CARRIER TAPE PITCH	PARTS PER REEL
BMI-S-205-F	1,500 x 1,000 (38,10 x 25,40)	.236 (6,00)	56 mm	44 mm	250

The cover is ordered as a separate part. The part number is BMI-S-205-C and is packaged in the same quantity as the frame.

APPLICATIONS:

- 121 BGA
- 32, 44, 52 PLCC
- 48, 100 VQFP
- 44, 48, 64, 80, 100 QFP

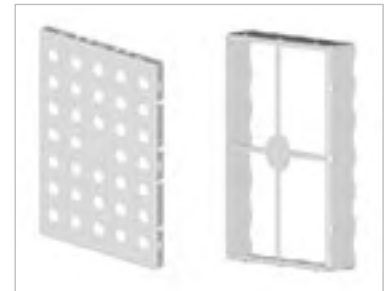

Dimensions (mm)

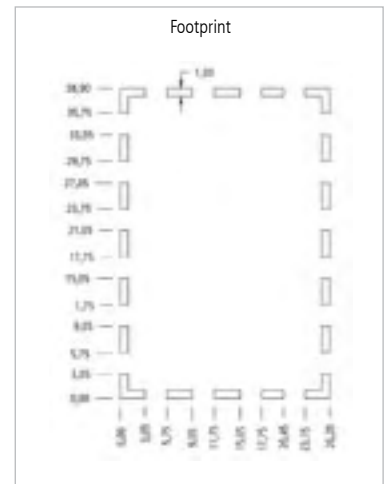
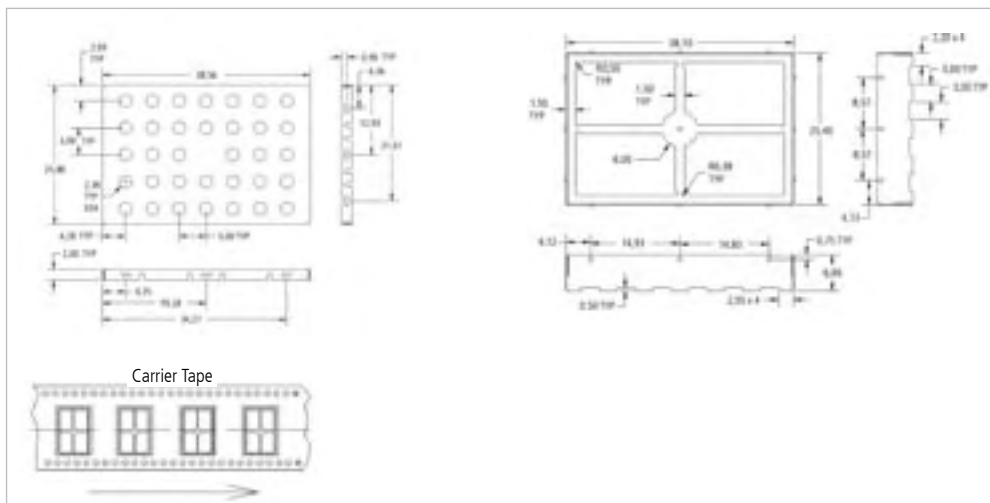



STANDARD SURFACE MOUNT SHIELD ONE-PIECE PART NO. BMI-S-106

DESIGN SPECIFICATIONS

PART NUMBER	MAXIMUM OVERALL DIMENSION	MAXIMUM OVERALL HEIGHT	CARRIER TAPE WIDTH	CARRIER TAPE PITCH	PARTS PER REEL
BMI-S-106	1,450 x 1,326 (36,83 x 33,68)	,200 (5,08)	56 mm	40 mm	300

APPLICATIONS:

- 121, 169, 225 BGA
- 32, 44, 52, 68 PLCC
- 48, 100 VQFP
- 44, 48, 64, 80, 100 QFP

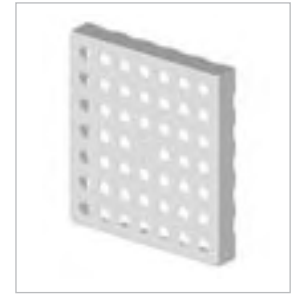

Dimensions (mm)

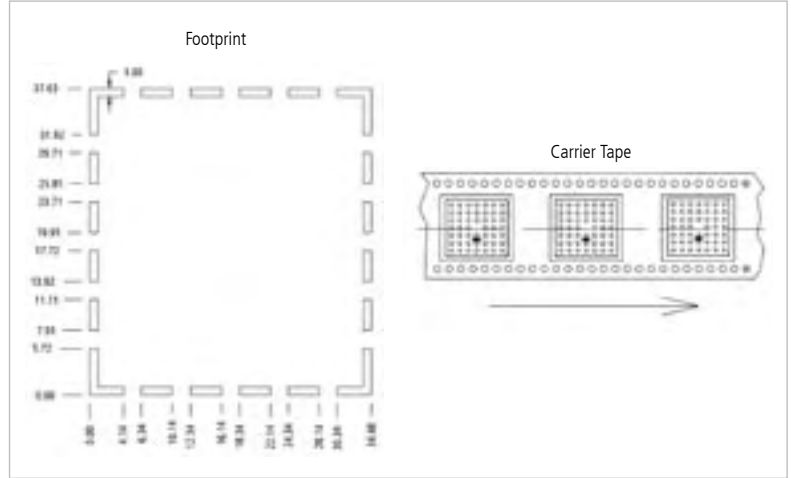
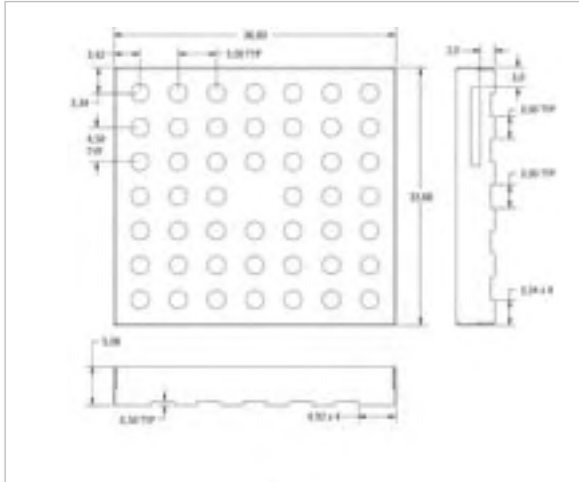

STANDARD SURFACE MOUNT SHIELD TWO-PIECE PART NO. BMI-S-206

DESIGN SPECIFICATIONS

PART NUMBER	MAXIMUM OVERALL DIMENSION	MAXIMUM OVERALL HEIGHT	CARRIER TAPE WIDTH	CARRIER TAPE PITCH	PARTS PER REEL
BMI-S-206-F	1,450 x 1,326 (36,83 x 33,68)	,200 (5,08)	56 mm	40 mm	300

The cover is ordered as a separate part. The part number is BMI-S-206-C and is packaged in the same quantity as the frame.

APPLICATIONS:

- 121, 169, 225 BGA
- 32, 44, 52, 68 PLCC
- 48, 100 VQFP
- 44, 48, 64, 80, 100 QFP

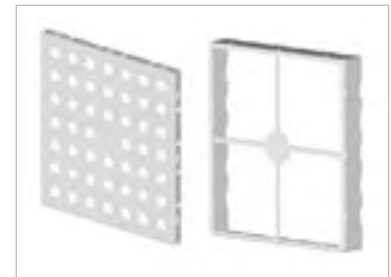

Dimensions (mm)

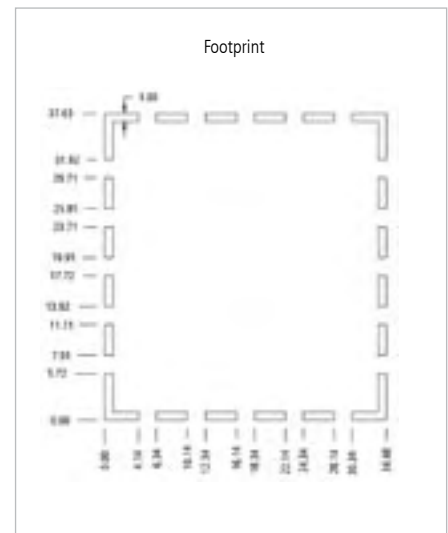
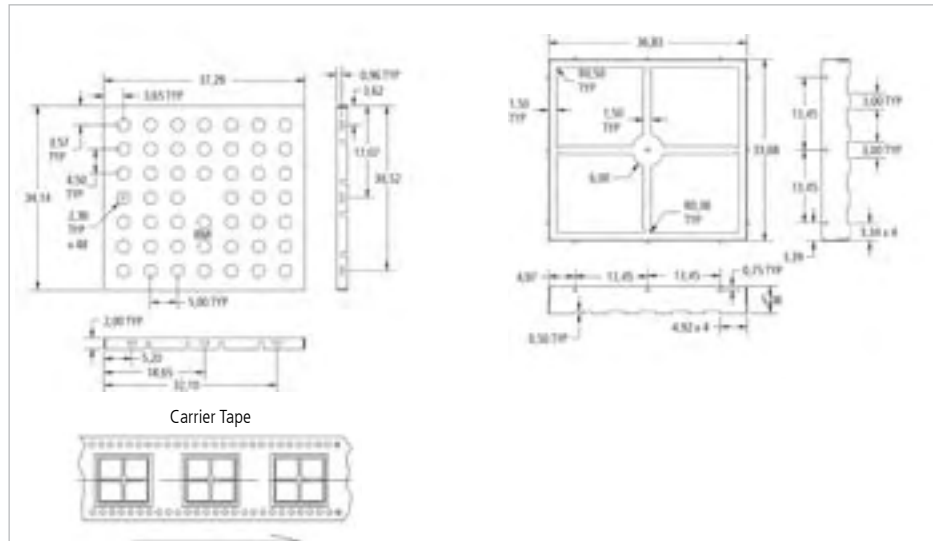



STANDARD SURFACE MOUNT SHIELD ONE-PIECE BMI-S-107

DESIGN SPECIFICATIONS

PART NUMBER	MAXIMUM OVERALL DIMENSION	MAXIMUM OVERALL HEIGHT	CARRIER TAPE WIDTH	CARRIER TAPE PITCH	PARTS PER REEL
BMI-S-107	1,747 x 1,747 (44,37 x 44,37)	.384 (9,75)	56 mm	56 mm	120

APPLICATIONS:

- Supplied in 56 mm EIA standard carrier tape
- 121, 169, 225, 313 BGA
- 32, 44, 52, 68, 84 PLCC
- 48, 100, 208 VQFP
- 44, 48, 64, 80, 100, 120, 160 QFP

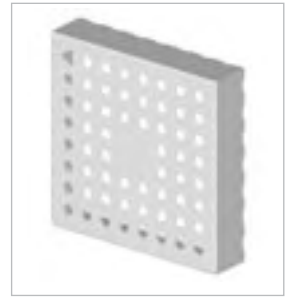

Dimensions (mm)

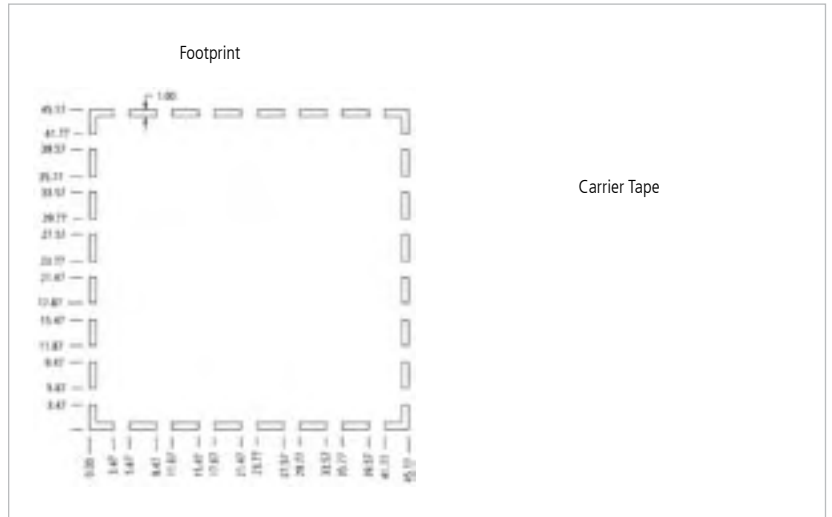
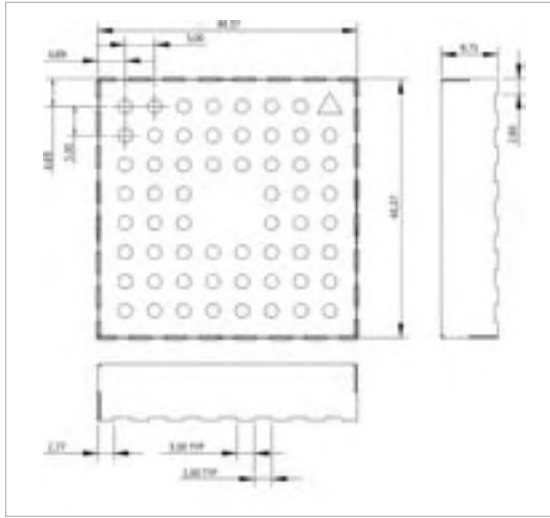

STANDARD SURFACE MOUNT SHIELD TWO-PIECE BMI-S-207

DESIGN SPECIFICATIONS

PART NUMBER	MAXIMUM OVERALL DIMENSION	MAXIMUM OVERALL HEIGHT	CARRIER TAPE WIDTH	CARRIER TAPE PITCH	PARTS PER REEL
BMI-S-207-F	1,747 x 1,747 (44,37 x 44,37)	.384 (9,75)	56 mm	56 mm	120

APPLICATIONS:

- 121, 169, 225, 313 BGA
- 32, 44, 52, 68, 84 PLCC
- 48, 100, 208 VQFP
- 44, 48, 64, 80, 100, 120, 160 QFP

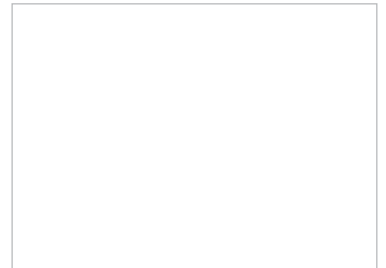

The cover is ordered as a separate part. The part number is BMI-S-207-C and is packaged in the same quantity as the frame.

Dimensions (mm)

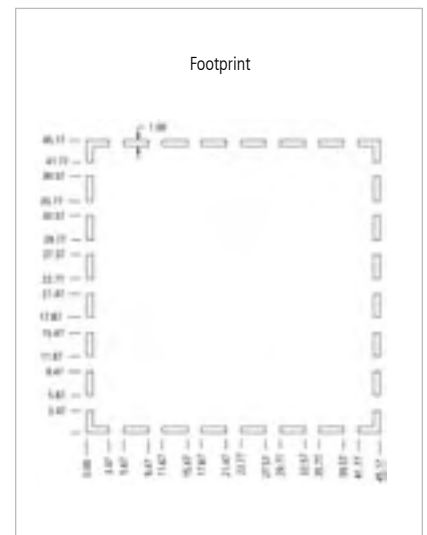
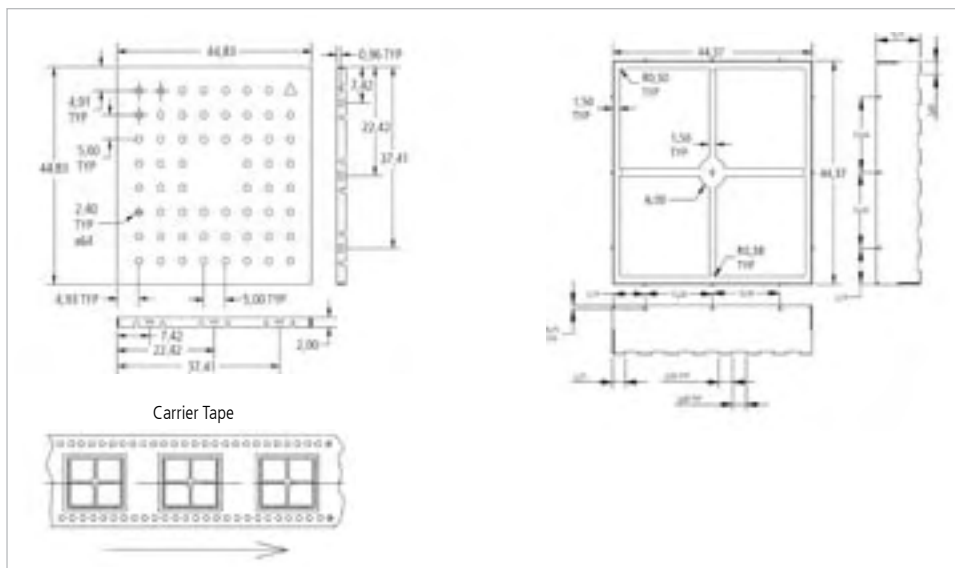



STANDARD SURFACE MOUNT SHIELD TWO-PIECE BMI-S-208

DESIGN SPECIFICATIONS

PART NUMBER	MAXIMUM OVERALL DIMENSION	MAXIMUM OVERALL HEIGHT	CARRIER TAPE WIDTH	CARRIER TAPE PITCH	PARTS PER REEL
BMI-S-208-F	1,559 x 1,559 (39,60 x 39,60)	,276 (7,00)	56 mm	48 mm	200

The cover is ordered as a separate part. The part number is BMI-S-208-C and is packaged in the same quantity as the frame.

Dimensions (mm)

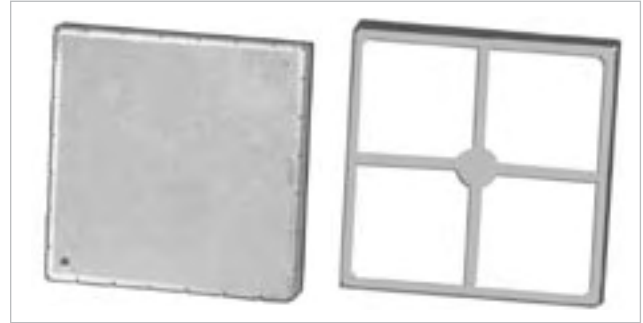
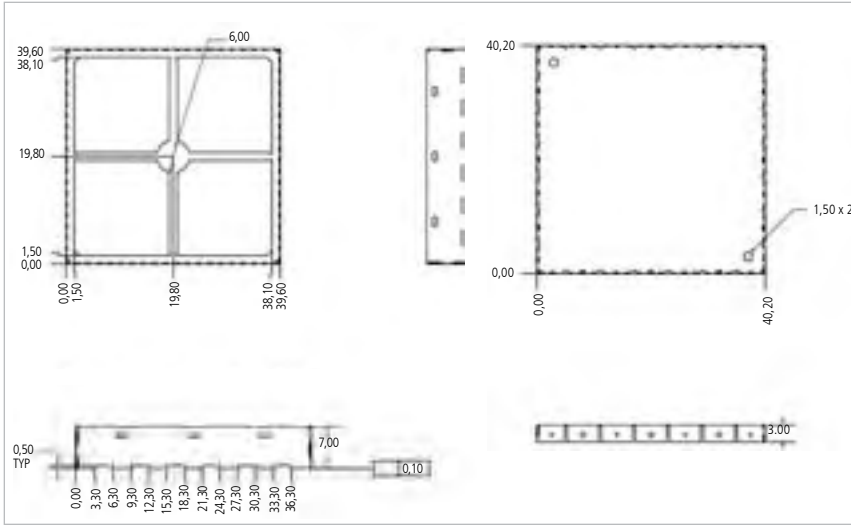

Footprint

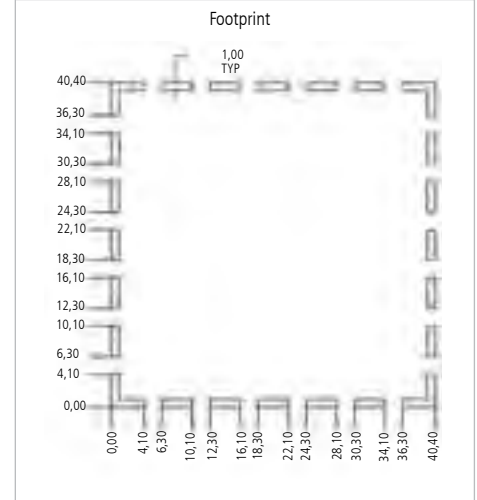

STANDARD SURFACE MOUNT SHIELD TWO-PIECE BMI-S-209

DESIGN SPECIFICATIONS

PART NUMBER	MAXIMUM OVERALL DIMENSION	MAXIMUM OVERALL HEIGHT	CARRIER TAPE WIDTH	CARRIER TAPE PITCH	PARTS PER REEL
BMI-S-209-F	1,156 x 0,728 (29,36 x 18,50)	,275 (7,00)	44 mm	28 mm	400

The cover is ordered as a separate part. The part number is BMI-S-209-C and is packaged in the same quantity as the frame.

Dimensions (mm)

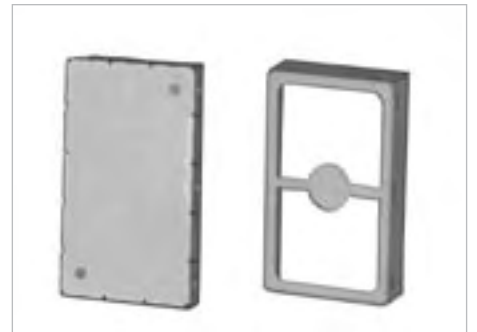
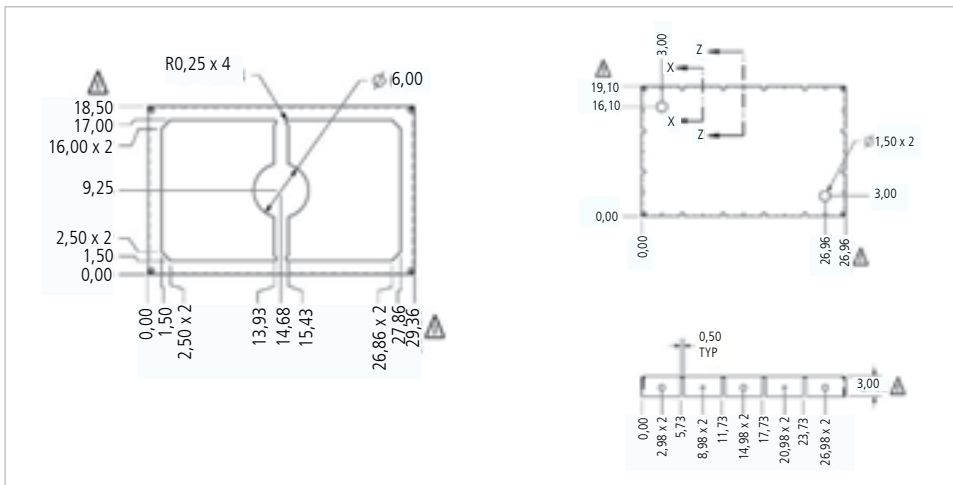

Footprint

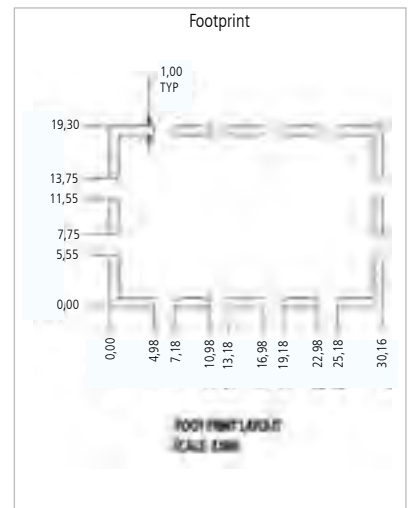



EZ PEEL™ STANDARD SHIELDS For Quick and Easy Access to Board Level Components

Laird Technologies offers four standard sizes of EZ Peel removable cover board level shields. These patented shields have a solid top, scored to allow peel-off when access to board level components within the shield is required.

The peel-off feature prevents damage to the board and components by eliminating the need for labor intensive de-soldering, which often results in increased scrap. Peeling off the cover is accomplished by using a small starter hole for simple removal. This hand operation requires minimal force using a hook scribe or tweezers.

After repair, replacement or adjustment of internal components, the shield can be resealed using a replacement cover. Laird Technologies offers two replacement cover options: a snap-in cover and a dish cover.

The snap-in cover utilizes a lance and hole design. The replacement cover snaps into place and locks into a lance feature on the frame of the original shield.

The other option is a dish cover that gets soldered into place on the board. The dish shape allows for self-location of the cover for soldering.

Standard EZ Peel board level shields can be packaged in tape and reel formats for easy SMT installation using conventional pick-and-place equipment. The four standard sizes are also available without the EZ Peel (scored) feature.

- Easy removal of scored cover area
- Only 1.5 lbs. force required for cover removal
- Simple replacement technique for cover
- Used on surface mount or through-hole applications
- Shield retains all physical properties after PCMCIA/ JEIDA testing for shock, bending, torque, drop and vibration
- CRS 1008/1010 (tin plated) for solderability
- RoHS compliant

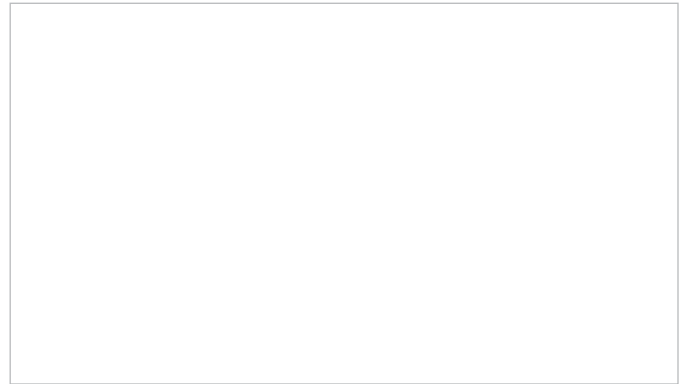
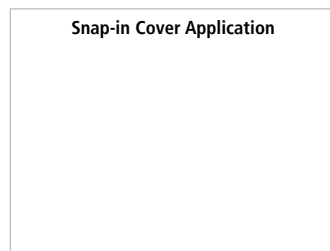
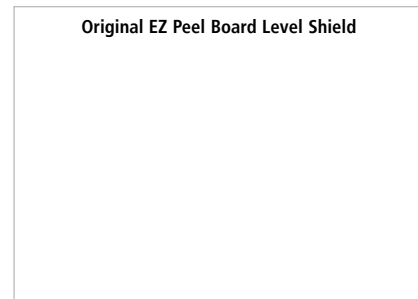

TABLE 1

EZ PEEL SHIELD PART NUMBER	REPLACEMENT LID OPTIONS	
	SNAP-IN LID NUMBER	DISH LID NUMBER
97-2002	97-2007	97-2014
97-2003	97-2006	97-2013
97-2004	Not Available	97-2016
97-2005	97-2008	97-2015



▲ After removal of scored section and application of snap-in cover



▲ After removal of scored section and application of dish cover

All dimensions shown are in (inches) millimeters unless otherwise specified.



EZ PEEL™ STANDARD SHIELDS PROFILES/DIMENSIONS

EZ Peel Board Level Shields

Solder Pad Footprint

Carrier Tape

97-2002

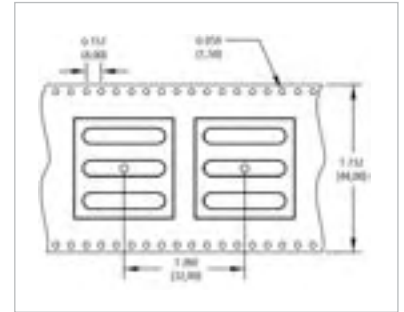
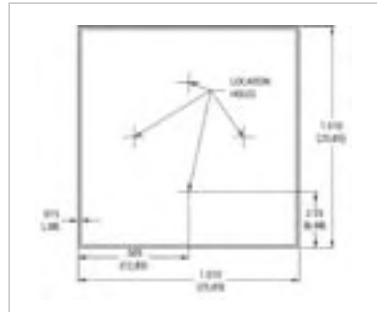
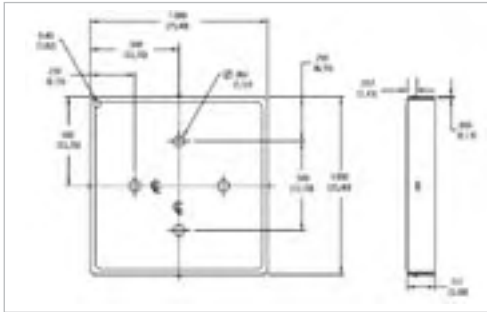

97-2003

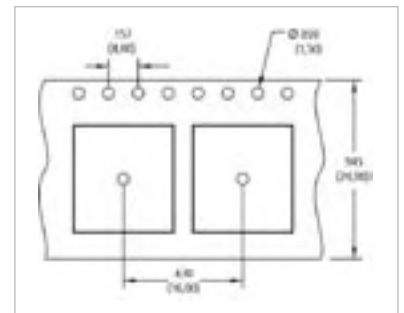
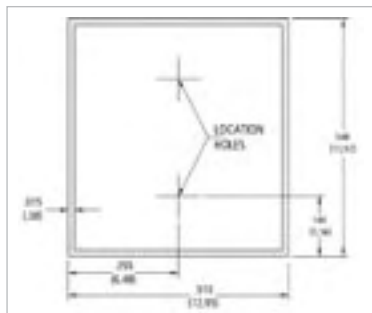
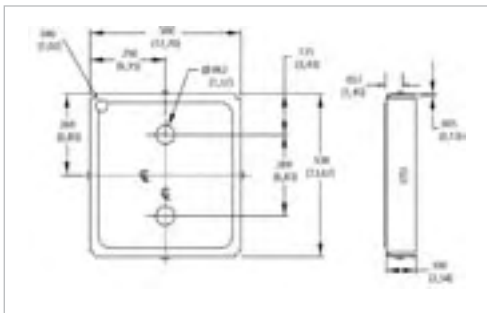

97-2004

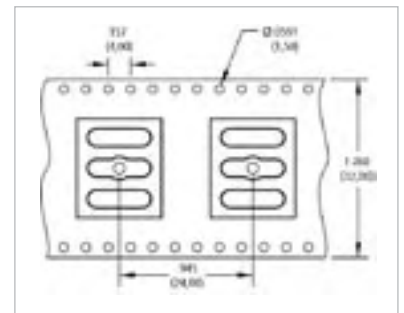
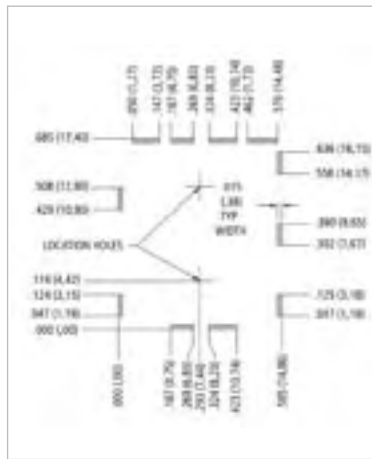
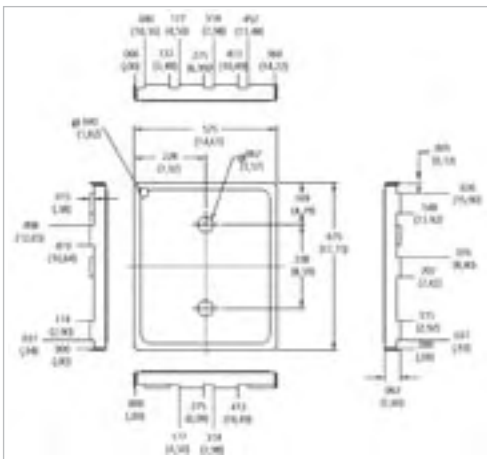

97-2005

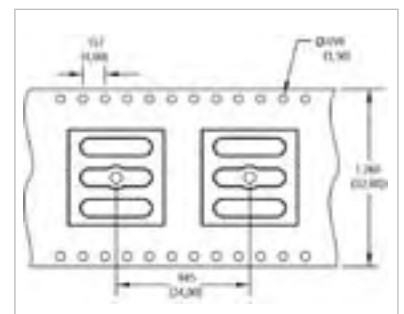
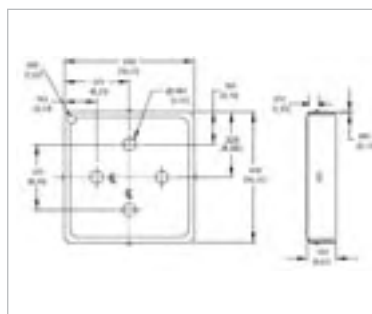
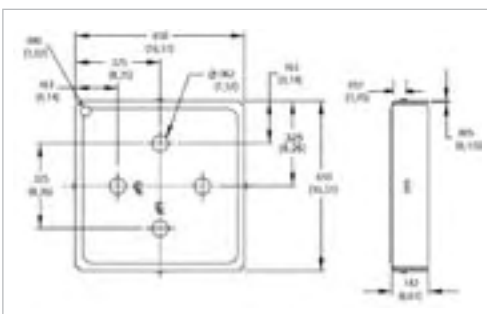

All dimensions shown are in (inches) millimeters unless otherwise specified.



STANDARD PRECISION ELECTRONIC CONTACTS

Laird Technologies standard precision electronic contacts ground, carry current and signals and interconnect boards and devices. A wide variety of plating options allow for the maximum electrical current carrying performance. An array of designs in a standard format are ready for production. Installed costs are lower with our tape and reel.

Typical Deflection Behavior of BMIC-001, BMIC-004, BMIC-006, and BMIC-007-01



STANDARD PRECISION ELECTRONIC CONTACTS

PART NUMBER	MATERIAL	AVAILABLE PLATINGS	TYPICAL APPLICATIONS	PARTS PER REEL
BMI-C-001	0,10 mm BeCu	Gold	Grounding, energy carrying	3000
BMI-C-001-SN	0,10 mm BeCu	Tin	Grounding, energy carrying	3000

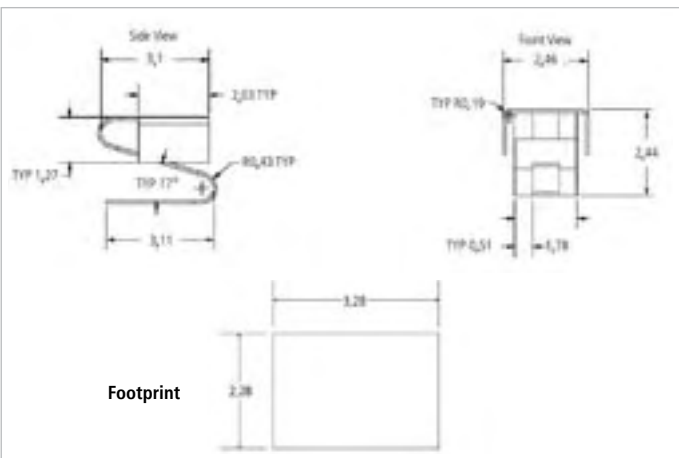

STANDARD PRECISION ELECTRONIC CONTACTS

CONTACTS	MATERIAL	AVAILABLE PLATINGS	TYPICAL APPLICATIONS	PARTS PER REEL
BMI-C-002	0,10 mm BeCu	Gold	Grounding, energy carrying	3500

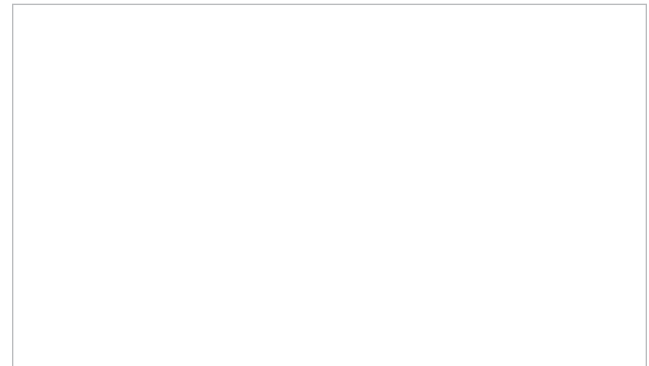
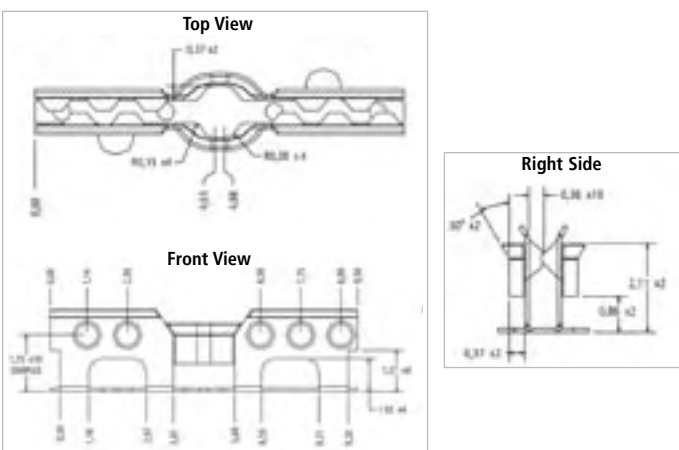

STANDARD PRECISION ELECTRONIC CONTACTS MATERIAL VARIATIONS

PART NUMBER	MATERIAL	AVAILABLE PLATINGS	TYPICAL APPLICATIONS	PARTS PER REEL
BMI-C-001	0,10 mm BeCu	Gold	Grounding, energy carrying	3000
BMI-C-001-SN	0,10 mm BeCu	Tin	Grounding, energy carrying	3000
BMI-C-002	0,10 mm BeCu	Gold	Grounding, energy carrying	3500
BMI-C-004	0,10 mm BeCu	Gold	Grounding, energy carrying	1400
BMI-C-004-SN	0,10 mm BeCu	Tin	Grounding, energy carrying	1400
BMI-C-006	0,10 mm BeCu	Tin	Grounding, energy carrying	3500
BMI-C-007-01	0,13 mm BeCu	Tin	Grounding, energy carrying	2300
BMI-C-010-*	0,20 mm Spring Steel	Tin	Standoff, support	3500 (Var)

Material properties are for reference only. Product testing by purchaser is recommended to confirm. Laird Technologies assumes no liability for product failure unless specifically stated in writing.

STANDARD PRECISION ELECTRONIC CONTACTS

PART NUMBER	MATERIAL	AVAILABLE PLATINGS	TYPICAL APPLICATIONS	PARTS PER REEL
BMI-C-004	0,10 mm BeCu	Gold	Grounding, energy carrying	1400
BMI-C-004-SN	0,10 mm BeCu	Tin	Grounding, energy carrying	1400

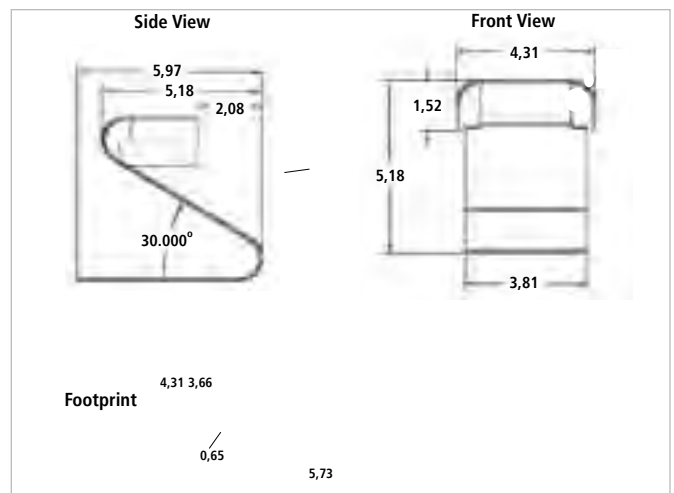

All dimensions shown are in (inches) millimeters unless otherwise specified.



STANDARD DESIGN SHIELDS AND CONTACTS

PART NO. BMI-C-006

PART NUMBER	MATERIAL	AVAILABLE PLATINGS	TYPICAL APPLICATIONS	PARTS PER REEL
BMI-C-006	0,10mm BeCu	Tin	Grounding, energy carrying	3500

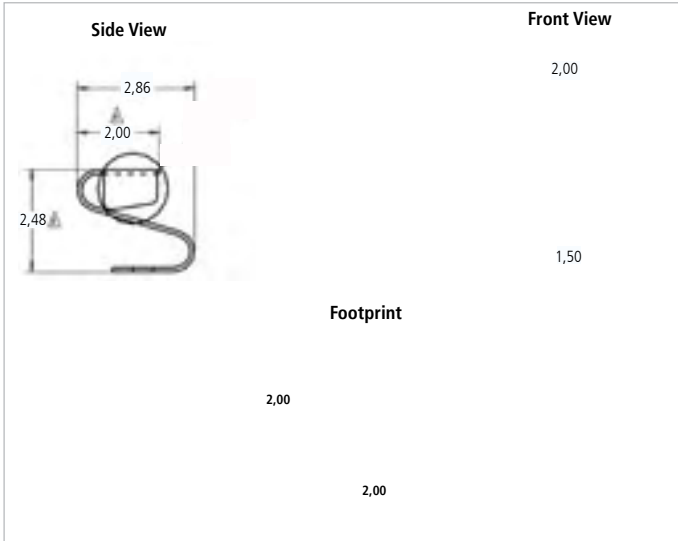

PART NO. BMIC-007-01

PART NUMBER	MATERIAL	AVAILABLE PLATINGS	TYPICAL APPLICATIONS	PARTS PER REEL
BMIC-007-01	0,13 mm	Tin	Grounding, energy carrying	2300

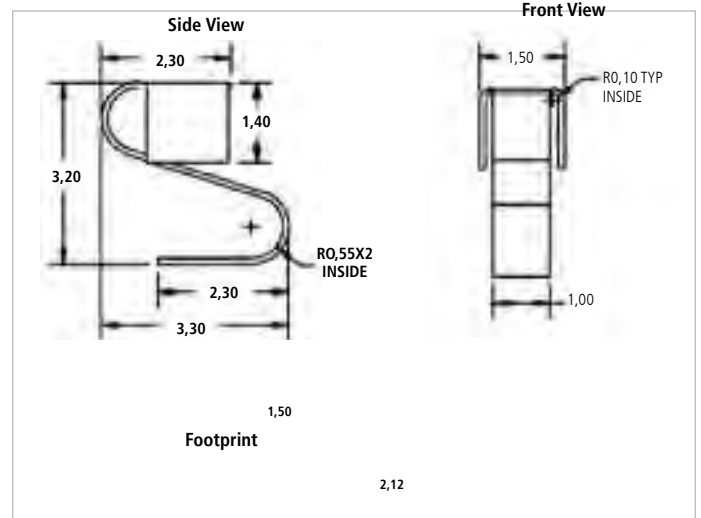

PART NO. BMI-C-010-*

CONTACTS	MATERIAL	AVAILABLE PLATINGS	TYPICAL APPLICATIONS	PARTS PER REEL
BMI-C-010-*	0,20 mm Spring Steel	Tin	Standoff, support	3500 (Var)

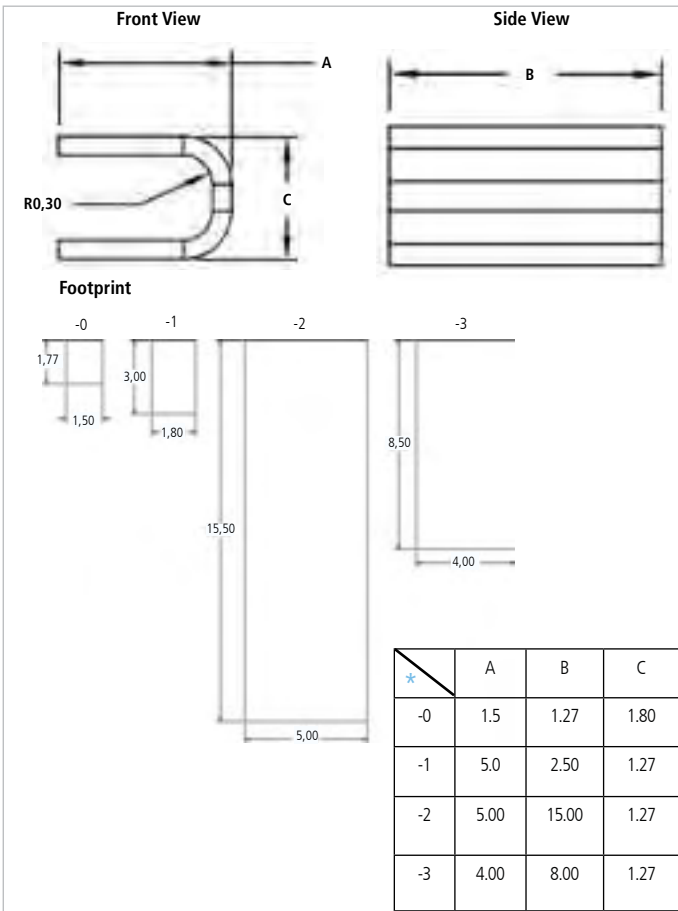

STANDARD SIZED PROTOTYPE PARTS

Standard prototype parts are available in select one-piece and two-piece sizes. Pricing based on volume and required prototype methods cost. Parts are manufactured in the prototype department to production tolerances with lead times typically less than two weeks.

Shields are made from high quality steel for excellent shielding performance across a wide frequency range. The tin plated surface provides excellent solderability and compatibility with lead-free processes. Upon request, part drawings and solder pad layouts are available.

ONE PIECE

PART NUMBER	BLS TYPE	DIMENSIONS in (mm)		
		LENGTH	WIDTH	HEIGHT
LT-BLS-139	one piece BLS	0.736 (18,70)	0.575 (14,60)	0.236 (6,00)
LT-BLS-137	one piece BLS	1.193 (30,30)	0.583 (14,80)	0.236 (6,00)
LT-BLS-138	one piece BLS	1.193 (30,30)	0.961 (24,40)	0.236 (6,00)
LT-BLS-141	one piece BLS	1.346 (34,20)	0.575 (14,60)	0.236 (6,00)
LT-BLS-136	one piece BLS	1.433 (36,40)	0.685 (17,40)	0.236 (6,00)
LT-BLS-143	one piece BLS	1.551 (39,40)	1.390 (35,30)	0.236 (6,00)

TWO PIECE

PART NUMBER	BLS TYPE	DIMENSIONS in (mm)		
		LENGTH	WIDTH	HEIGHT
LT-BLS-215	two piece	1.300 (33,02)	1.065 (27,05)	0.400 (10,16)
LT-BLS-224	two piece	1.650 (41,91)	1.375 (34,93)	0.400 (10,16)
LT-BLS-216	two piece	1.770 (44,96)	1.065 (27,05)	0.400 (10,16)
LT-BLS-213	two piece	2.130 (54,10)	1.065 (27,05)	0.400 (10,16)
LT-BLS-225	two piece	2.250 (57,15)	1.375 (34,93)	0.400 (10,16)
LT-BLS-219	two piece	2.756 (70,00)	2.240 (56,90)	0.400 (10,16)
LT-BLS-229	two piece	2.775 (70,49)	1.685 (42,80)	0.400 (10,16)
LT-BLS-226	two piece	2.800 (71,12)	1.375 (34,93)	0.400 (10,16)
LT-BLS-227	two piece	3.375 (85,73)	1.375 (34,93)	0.400 (10,16)

On two piece BLS, dimensions shown are the exterior frame dimensions.



INTRODUCTION

The complexities of today's electronics pose several design challenges. Resolving EMI needs to be balanced with space, weight and production restraints. When designing a custom shielding solution, beginning in the earliest stages of the application design allows effective elimination of EMI while meeting all specifications.

Laird Technologies board level shielding experts work through all phases of development. From design, rapid prototyping and pre-production through production and automated packaging, Laird Technologies has the experience to help speed a product to market and stay within budget.

To increase manufacturing throughout and reduce costs, Laird Technologies has developed a proprietary in-line production process that includes part formation, wash, assembly, inspection and automated packaging.

By integrating quality processes, board level shield quality and performance is ensured from design stage through final packaging. One process is the automated co-planarity inspection system. Laird Technologies replicates the customer application by measuring shields in the same plane as the printed circuit board. This is accomplished without "securing" or "touching" shields, which could throw off measurement and/or deform parts. Laird Technologies measures shields immediately prior to placement into carrier tape at speeds that match automation packing.

Shield base materials include our exclusive Shield-Lite™, CRS 1008/1010, beryllium copper alloys, nickel-silver alloys, copper-based alloys and spring steels. All shields are fully solderable.

SURFACE MOUNT SHIELDS MATERIAL VARIATIONS

RAW MATERIAL*	THICKNESS in (mm)	HEAT TREATMENT	PLATING	COMMENTS
CRS base box steel 1008/1010	0.005 to 0.090 (0,127 to 2,286)	No heat treatment	Tin	Pre-plated
Beryllium-copper alloys	0.004 to 0.008 (0,102 to 0,203)	Heat treatable in all temperatures	Tin, palladium, nickel, gold	Pre-tempered & pre-plated
Nickel-silver alloys	0.004 to 0.016 (0,102 to 0,406)	Stress annealed	Fully solderable (if used with LT proprietary process)	No plating required for SMT solderability
Copper-based alloys	0.004 to 0.012 (0,102 to 0,305)	No heat treatment	Tin, palladium, nickel, gold	Pre-tempered & pre-plated
Spring steel	0.006 to 0.060 (0,152 to 1,524)	Austemper	Tin, nickel, black oxide	Spring properties determined by application
Phosphor Bronze alloys	0.004 to 0.020 (0,100 to 0,510)	N/A	Tin, palladium, nickel, gold	Pre-tempered & Preplated

*Other materials may be available, please consult sales.

Material properties are for reference only. Product testing by purchaser is recommended to confirm. Laird Technologies assumes no liability for product failure unless specifically stated in writing.

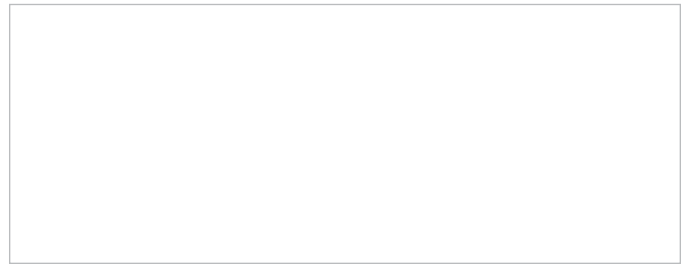

ONE-PIECE SHIELD DESIGN

Low Cost/Excellent Effectiveness

Custom surface mount shields are available in both one-piece and two-piece designs. One-piece shields provide six sides of protection, with the sixth side being the board itself. One-piece designs offer economical shielding alternatives where access to covered components for repair is not necessary.

TWO-PIECE SHIELD DESIGN

Quick, Easy Repair and Inspection of Covered Components

Two-piece board level shields offer users the flexibility to inspect or repair shielded components without having to risk board damage by removing the entire shield. Covers snap on and off with ease, making repairs quicker and easier, and reducing board re-work. Two-piece shields are available pre-assembled or unassembled. Large locking dimples snap into slots on covers to provide mechanical retention force. Smaller grounding dimples provide electrical grounding for proper shielding and to prevent rattle. Two-piece shields survive drop, shock and no-rattle tests. Here are critical test results:

- Able to withstand acceleration of 4g from 10 Hz to 2000 Hz for three hours in each of three planes as per SAE J1455
- Pass EN 50 155 for railway electrical equipment including vibration test of 30g from 5 Hz to 200 Hz in 3 directions and a shock test with 500 m/s for 11/ms
- Pass standard telecommunications drop tests [6 faces, dropped 1 meter onto concrete floor]



EZ PEEL™ SHIELD DESIGN

Economical Access for Low Incidences of Repairs

In cases where there is a low incidence of repairable circuit defects, access may be needed to shielded components. An economical solution is EZ Peel shields. These one-piece shields feature an easy-to-remove top section that can be peeled back using simple tools for access to components. Built-in flexibility controls the ease of removing the top, and the robust design delivers superior flatness. EZ Peel shields are designed to accept a snap-on cover in the same manner as our two-piece shields, following circuit repair.



MULTI-COMPARTMENTAL SHIELD DESIGN

Shield Multiple Circuit Groups Save PCB Space and Production Time

Printed circuit boards with multiple circuit groups pose unique design challenges. Shielding these groups separately adversely affects circuit board real estate and increases part count. Multi-compartmental shields allow replacement of three or more single shields with one shield divided into several walled compartments. Installing a single part reduces part count, along with production time through faster pick-and-place speeds. This allows for a reduction the number of parts in inventory, which lowers overhead costs.

Multi-compartmental shields feature internal dividing walls of one material thickness and meet all on-board shield requirements for FCC, VDE, CISPR and CE. These shields are available in two-piece designs, either assembled or unassembled. Our unassembled versions allow for automatic optical inspection prior to cover placement. As in all our shielding offerings, Laird Technologies proprietary process for 100% automatic optical inspection verifies co-planarity including inner walls.

DRAWN BOARD LEVEL SHIELDS

Seamless Corners Address High-Frequency Leakage

As microprocessor speeds continue to increase, so does the potential for EMI leakage through the smallest apertures in board level shields. Laird Technologies drawn board level shields are designed to provide additional near-field and far-field circuit isolation (attenuation) at higher frequencies by eliminating the apertures found in the corners of traditional board level solutions. Drawn board level shields utilize small ground trace sizes, thereby preserving space on the circuit board.

- Solid corner designs when additional circuit isolation (attenuation) is required at higher frequencies
- Available in custom heights up to .250" (6,4 mm) with length and width dimensions from .300" (7,6 mm) to 2.0" (50,8 mm)
- Tape and reel packaging provides an economical and automated SMT attachment method

- Available in cold rolled steel, brass, stainless steel and nickel silver
- Molded Compartment Shields and Form-In-Place elastomers can be combined with drawn board level shields to achieve shielding of multiple components with a single part
- Available with an EZ Peel scored cover feature; allows for easy top section removal for component repair and re-sealing
- Ventilation holes as needed for solder outgassing.

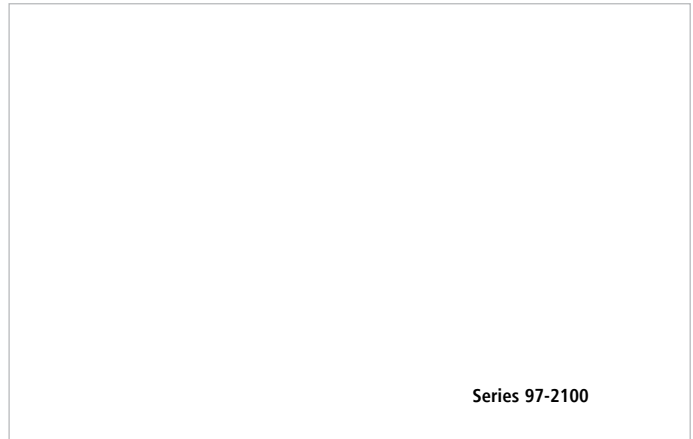

Series 97-2100

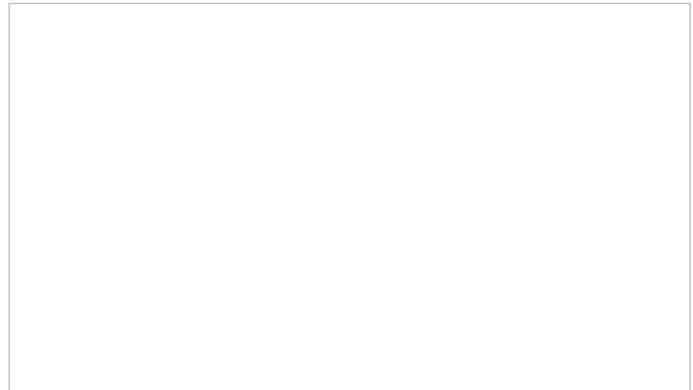
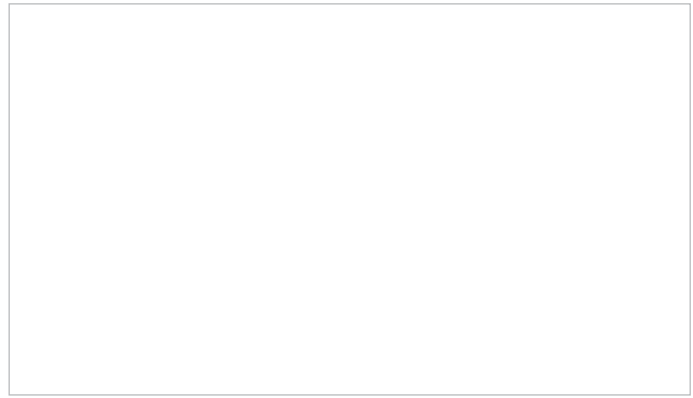

▲ The receive antenna test region from 1 GHz to 10 GHz that defines the Far-Field and Near-Field is 2.0" and 0.190", respectfully, from the transmit antenna. This test is performed for worst case orientation.

Circuit Isolation is a measurement that defines the resultant attenuation level in dB provided by a PCB shield from an initial reference level as defined in Laird test procedure PDA-PRO-027.

Notice: The data set forth in all text, tables, charts, graphs and figures herein are based on samples tested and are not guaranteed for all samples or applications. Such data are intended as guides and do not reflect product specification for any specific part.



CUSTOM PRECISION ELECTRONIC CONTACTS Gain Maximum Electrical and Carrying Performance

From concept to placement, Laird Technologies has the expertise to deliver custom precision surface mount contacts. Using the latest computer simulation techniques, Laird Technologies provides properly designed contacts that ground, carry current and signals, and interconnect boards and devices. Laird Technologies uses basic geometric parameters (length, width, uncompressed height, compressed height, contact force) to conduct Finite Element Analysis (FEA) on your prospective design.

With the FEA results, we can then identify the best design to optimize a product's operational performance. Features are incorporated to provide for placement and soldering of the contact onto the circuit board.

Laird Technologies offers a wide range of plating options to allow for maximum electrical current carrying performance.

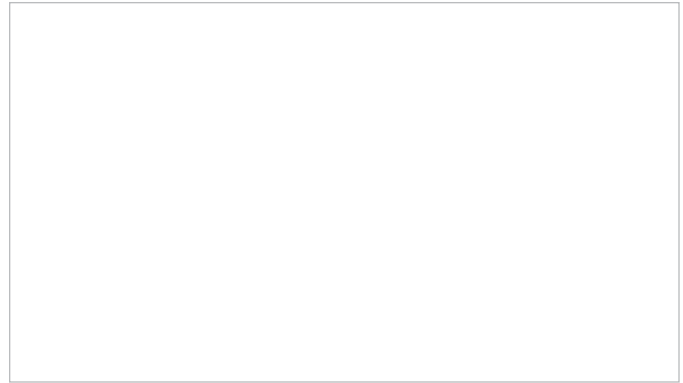

▲ Automated packaging allows for complex and small designs with lower installed costs.

Contact base materials include beryllium copper, phosphor bronze, nickel and stainless steel. All contacts are fully solderable as required.

CUSTOM PRECISION ELECTRONIC CONTACTS MATERIAL VARIATIONS

TYPE	THICKNESS in (mm)	HEAT TREATMENT	PLATING/COATING	COMMENTS
Beryllium Copper Alloys: 17200, 190, 290, 174	.0035 to .080 (0,089 to 2,03)	Heat Treatable	Tin, palladium, nickel, gold, silver	Heat Treated as necessary Pre-Plated or Post Plated
Phosphor Bronze Alloys: 510, 505, 511, 521, 544	.004 to .090 (0,10 to 2,29)	N/A	Tin, palladium, nickel, gold, silver	Pre-Plated or Post Plated
Copper Alloys: 110, 102, 122, 1093	.006 to .125 (0,15 to 3,18)	N/A	Tin, palladium, nickel, gold, silver	Pre-Plated or Post Plated
Brass Alloys: 260, 210, 220, 226, 230, 240, 268, 350, 353	.004 to .090 (0,10 to 2,29)	N/A	Tin, palladium, nickel, gold, silver	Pre-Plated or Post Plated
Nickel Silver Alloys: 770, 752, 762	.004 to .060 (0,10 to 1,52)	N/A	Tin, palladium, nickel, gold, silver	Solderable in unplated condition (if used with LT proprietary process)
Spring Steel Alloys: 1050, 1065, 1074, 1095	.008 to .080 (0,20 to 2,03)	Austemper	Tin, nickel, black oxide	Plated after heat treatment
Stainless Steel Alloys: 301, 302, 305, 316, 201, 202	.004 to .090 (0,10 to 2,29)	N/A	Tin, gold	Pre-Plated or Post Plated
Stainless Steel Alloys: 410, 420	.004 to .090 (0,10 to 2,29)	Heat Treatable	Tin, gold	Heat Treated as necessary Pre-Plated or Post Plated
Titanium Copper	.004 to .012 (0,10 to 0,30)	N/A	Tin, palladium, nickel, gold, silver	Heat Treated as necessary Pre-Plated or Post Plated
Special Alloys: Clad metals	.0035 to .080 (0,089 to 2,03)	N/A	Tin, palladium, nickel, gold, silver, palladium-silver	Pre-Plated or Post Plated
Post Plating	Thickness as required	N/A	Tin, nickel, gold, silver, zinc, black oxide, black zinc, phosphate	N/A

Additional material choices are available upon request. Material properties are for reference only. Product testing by purchaser is recommended to confirm. Laird Technologies assumes no liability for product failure unless specifically stated in writing.







