

THIS DOCUMENT IS THE PROPERTY OF
KEYSTONE ELECTRONICS CORP. AND
SHALL NOT BE REPRODUCED, DISTRIBUTED
OR USED AS A BASIS FOR MANUFACTURE
WITHOUT PRIOR WRITTEN PERMISSION
FROM KEYSTONE ELECTRONICS CORP.

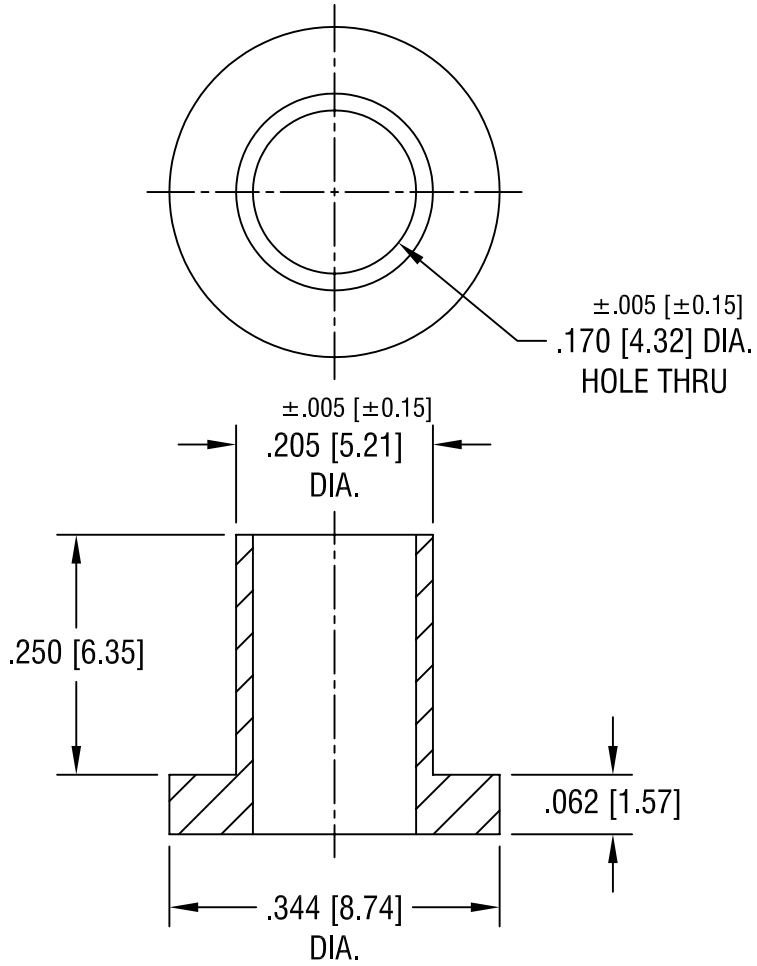

KEYSTONE ELECTRONICS CORP.

ASTORIA, N.Y. 11105-2017

PART NAME

NYLON SHOULDER WASHER

MATERIAL

NYLON 6/6

FINISH

-

DRN BY

BOONE

DATE

4.18.06

APP'D

LN

SCALE

5X

TOLERANCES

INCH [MM]

DECIMAL $\pm .010$ [± 0.25]

ANGULAR $\pm 1^\circ$
UNLESS OTHERWISE SPECIFIED

CODE

DWG NO.

C/M

3105

DATE

DESCRIPTION

REV.