

Application & Main Feature

Commercial Grade (Soft Termination)

Series

C3225 [EIA 1210]

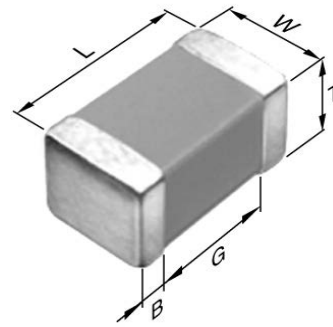

Dimensions

L	3.20mm +0.5,-0.4mm
W	2.5mm +/-0.3mm
T	2.00mm +0.3,-0.2mm
B	0.20mm Min.
G	

Temperature Characteristic

C0G (-55 to 125 degC 0+/-30ppm/degC)

Rated Voltage

3A(1000Vdc)

Capacitance

3.3nF

Capacitance Tolerance

J (+/-5%)

Q Factor

1000 Min.

Insulation Resistance

10Gohm Min

AEC-Q200

Not Applicable

|Z|, ESR vs. Freq. Characteristics
(Simulation Data)

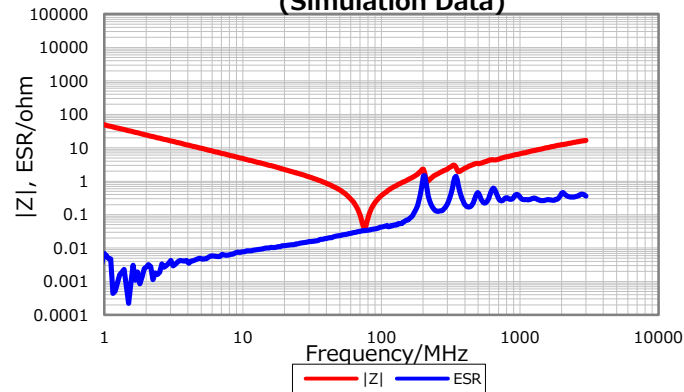

DC Bias Characteristic

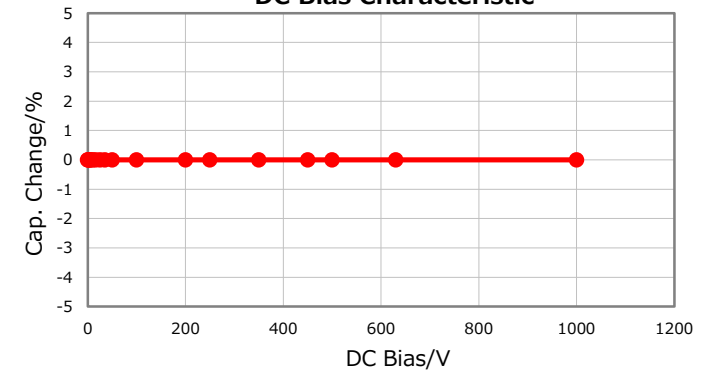

Cap. vs. Freq. Characteristic

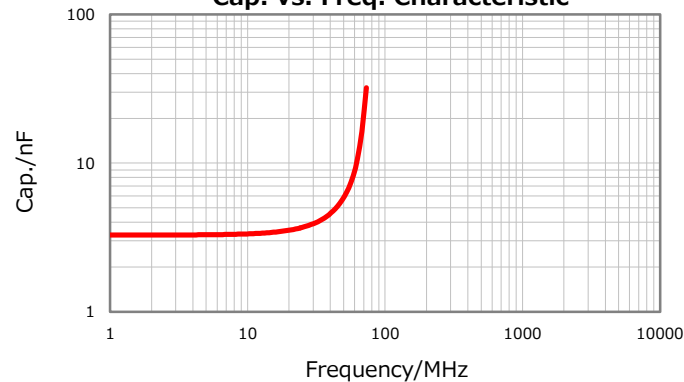

Temperature Characteristics

