

Specification

SSC-SAW8P42A

SAW8P42A

Description

This surface-mount LED comes in standard package dimension. It has a substrate made up of a molded plastic reflector sitting on top of a bent lead frame. The die is attached within the reflector cavity and the cavity is encapsulated by silicone.

The package design coupled with careful selection of component materials allow these products to perform with high reliability.

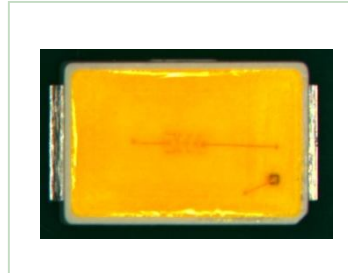

SAW8P42A

Features

- Suitable for all SMT assembly methods; Suitable for all soldering
- Lead Free product
- RoHS compliant

Applications

- Interior lighting
- General lighting
- Indoor and door displays
- Architectural/Decorative lighting

Contents

- 1. Outline dimensions**
- 2. Characteristics of SAW8P42A LED**
- 3. Characteristic diagrams**
- 4. Color & Binning**
- 5. Bin Code Description**
- 6. Labeling**
- 7. Packing**
- 8. Recommended solder pad**
- 9. Soldering**
- 10. Precaution for use**
- 11. Handling of Silicone Resin LEDs**

1. Outline dimensions

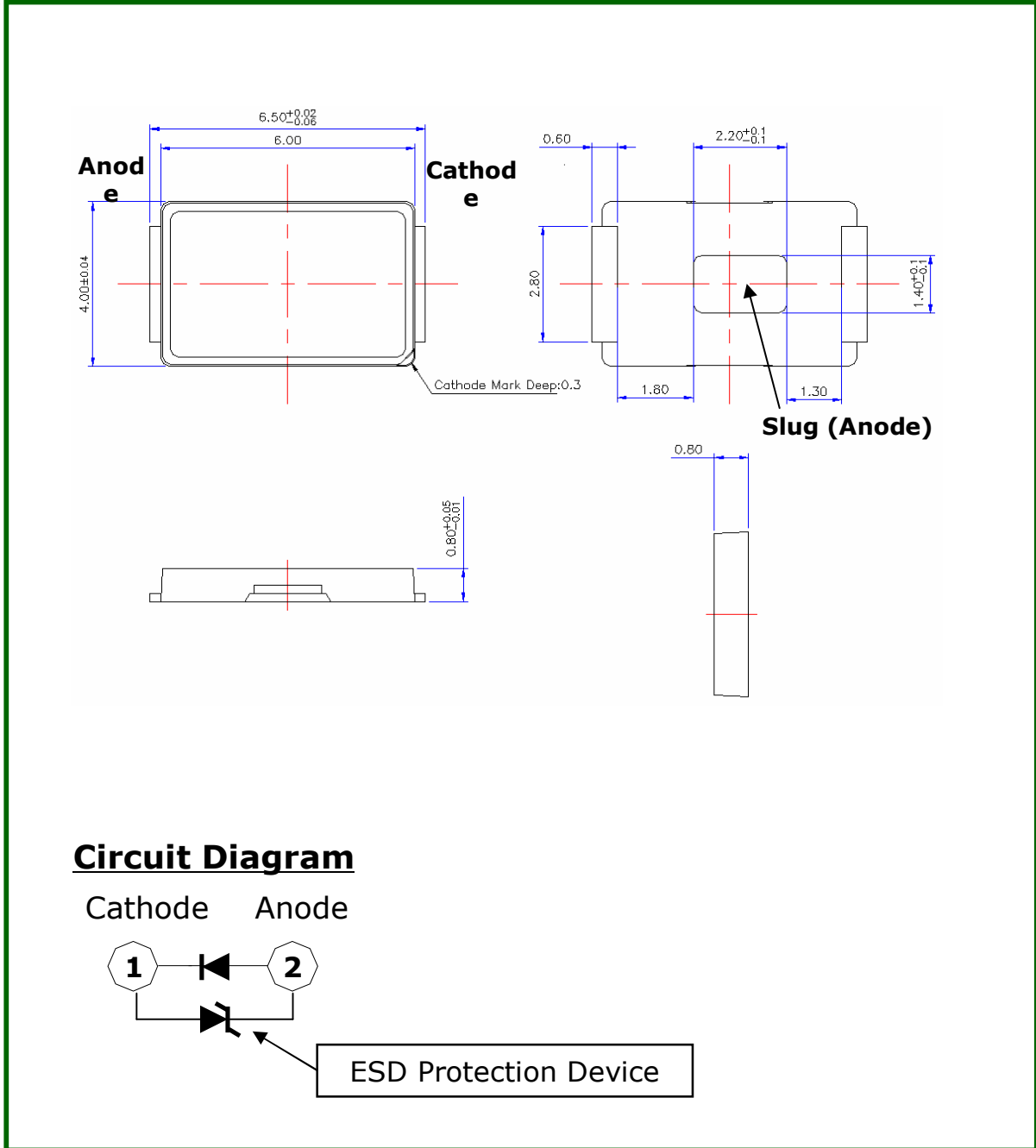

Notes :

- [1] All dimensions are in millimeters.
- [2] Scale : none
- [3] Undefined tolerance is ±0.1mm

2. Characteristics of SAW8P42A

(Ta=25℃)

Electro-Optical characteristics

Parameter	Symbol	Condition	Min.	Typ.	Max.	Unit
Forward Voltage*	V_F	$I_F=20mA$	11.8	13.0	14.2	V
Reverse Voltage	V_R	$I_R=5mA$	-	0.7	1.2	V
Luminous Intensity ^[1] (3700~7000K)	I_V	$I_F=20mA$	8.5 (26.4)	9.7 (30.1)	10.5 (32.5)	Cd (lm)
Color Correlated Temperature	CCT	$I_F=20mA$	3,700	-	7,000	K
Viewing Angle ^[2]	$2\theta_{1/2}$	$I_F=20mA$		115		deg.
Color Rendering Index*	R_a	$I_F=20mA$	80	83	90	-
ESD (HBM)		1.5kΩ;100 pF	5	-	-	KV
Thermal resistance ^[3]	$R\theta_{J-S}$	$I_F=20mA$	-	20	-	K/W

[1] The luminous intensity I_V was measured at the peak of the spatial pattern which may not be aligned with the mechanical axis of the LED package.

[2] $2\theta_{1/2}$ is the off-axis where the luminous intensity is 1/2 of the peak intensity.

[3] Thermal resistance: R_{thJS} (Junction / solder)

* Tolerance : $V_F : \pm 0.4V$, $I_V : \pm 7\%$, $R_a : \pm 2$, $x, y : \pm 0.01$ [Note] All measurements were made under the standardized environment of SSC.

Absolute Maximum Ratings

Parameter	Symbol	Value	Unit
Power Dissipation *^[1]	P_d	0.43	W
Forward Current	I_F	30	mA
Operating Temperature	T_{opr}	-30~+85	℃
Storage Temperature	T_{stg}	-40~+100	℃
Junction Temperature	T_j	125	℃

[1] Care is to be taken that power dissipation does not exceed the absolute maximum rating of the product.

* LED's properties might be different from suggested values like above and below tables if operation condition will be exceeded our parameter range.

REV.00

May 2012

www.seoulsemicon.com

3. Characteristic diagrams

Color Spectrum, Ta=25°C

1. Cool white 4700 K~7000 K
2. Neutral white 3700 K~4700 K

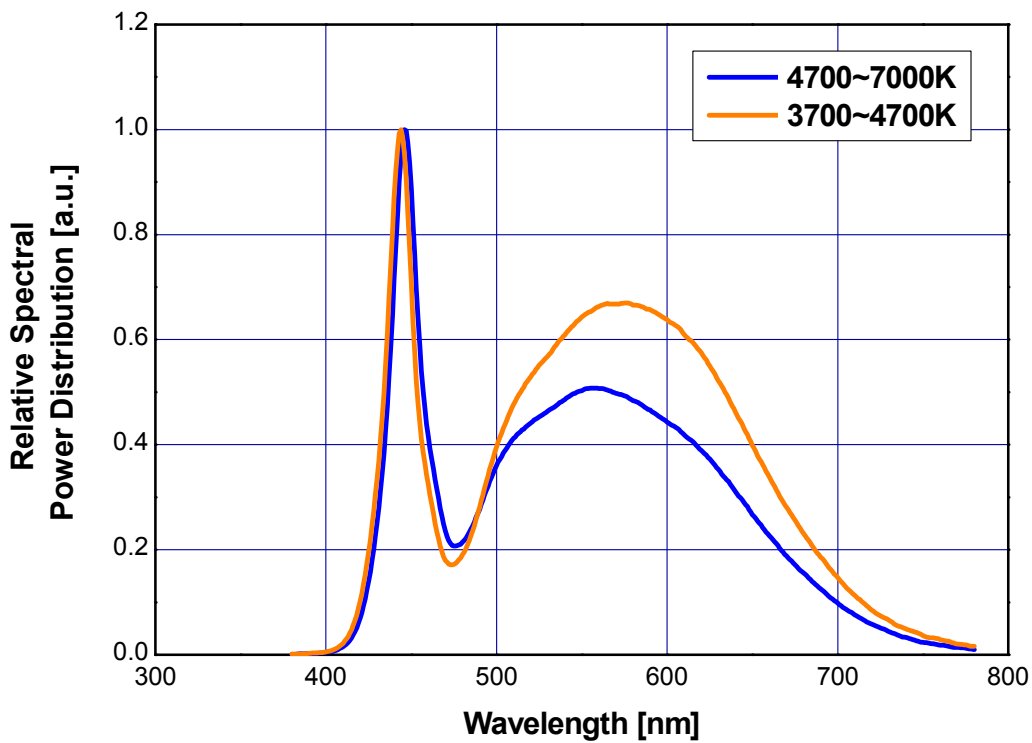

Current – Voltage characteristics, Ta=25°C

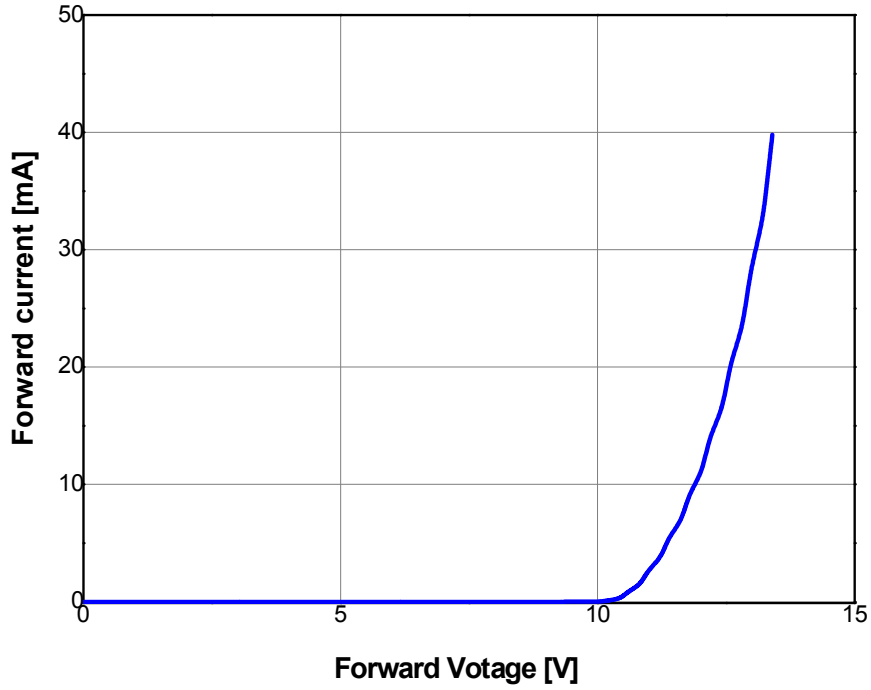

Forward Current–Relative Luminous Intensity characteristics, Ta=25°C

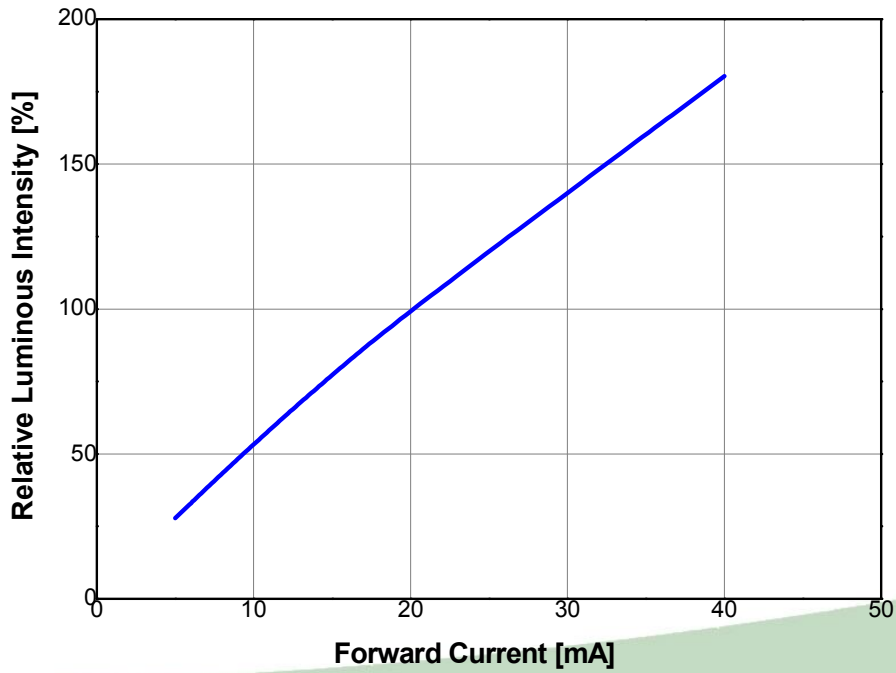

Forward Voltage Shift - Junction Temperature characteristics, IF=20mA

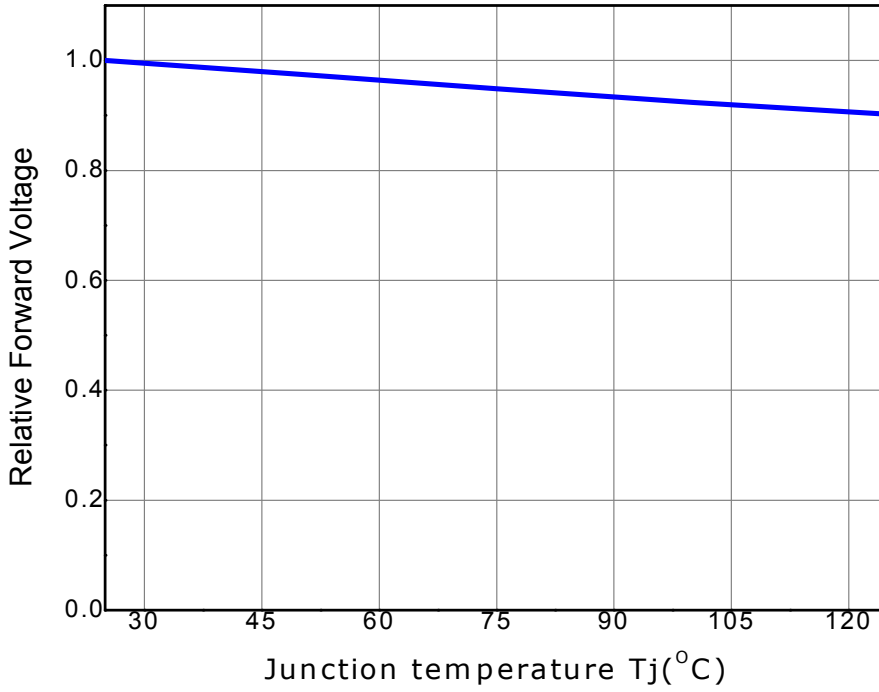

Relative Light Output - Junction Temperature characteristics, IF=20mA

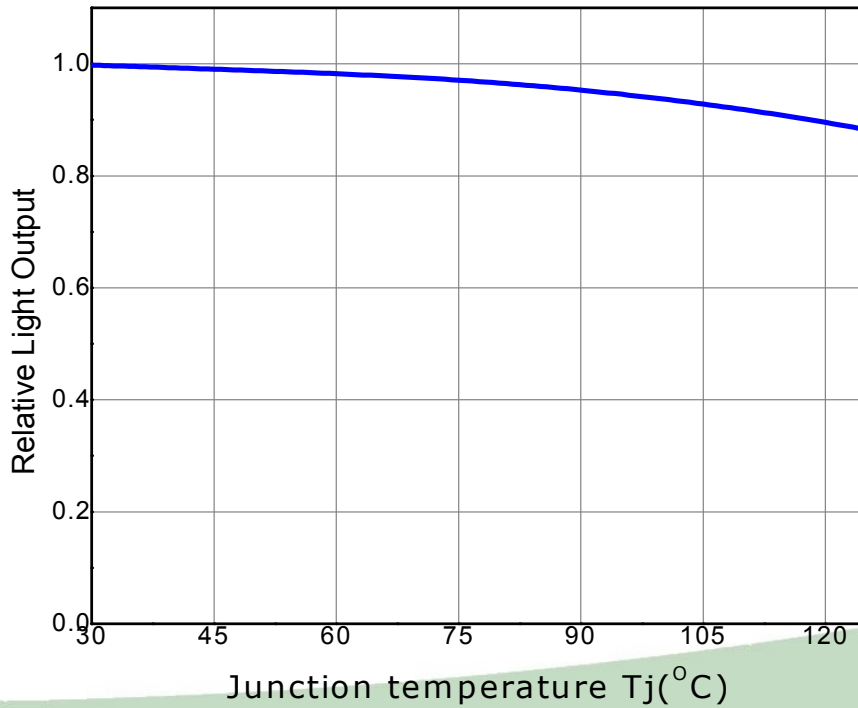

Viewing Angle Characteristics, IF=20mA

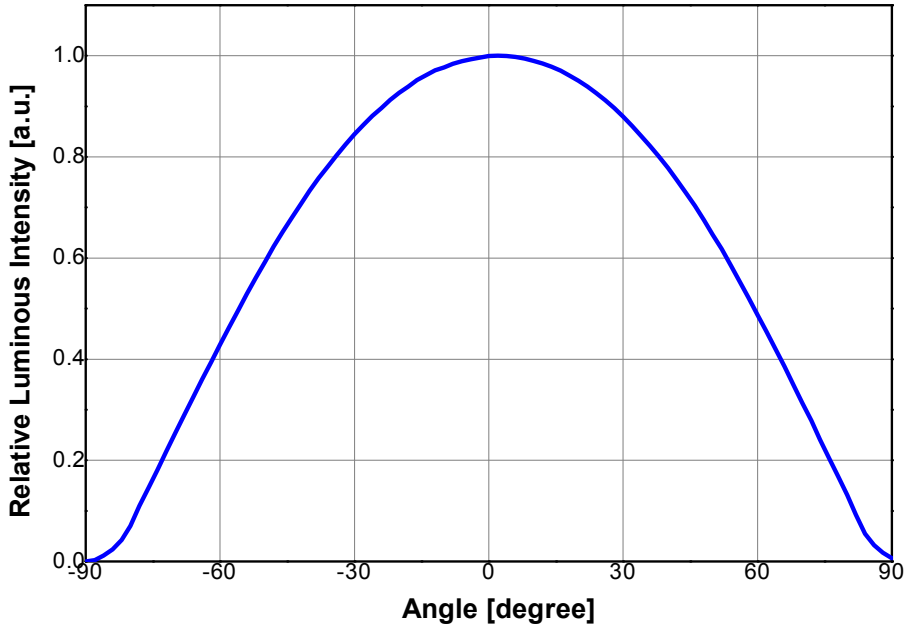

Forward Current -Chromaticity Coordinate characteristics, Ta=25°C

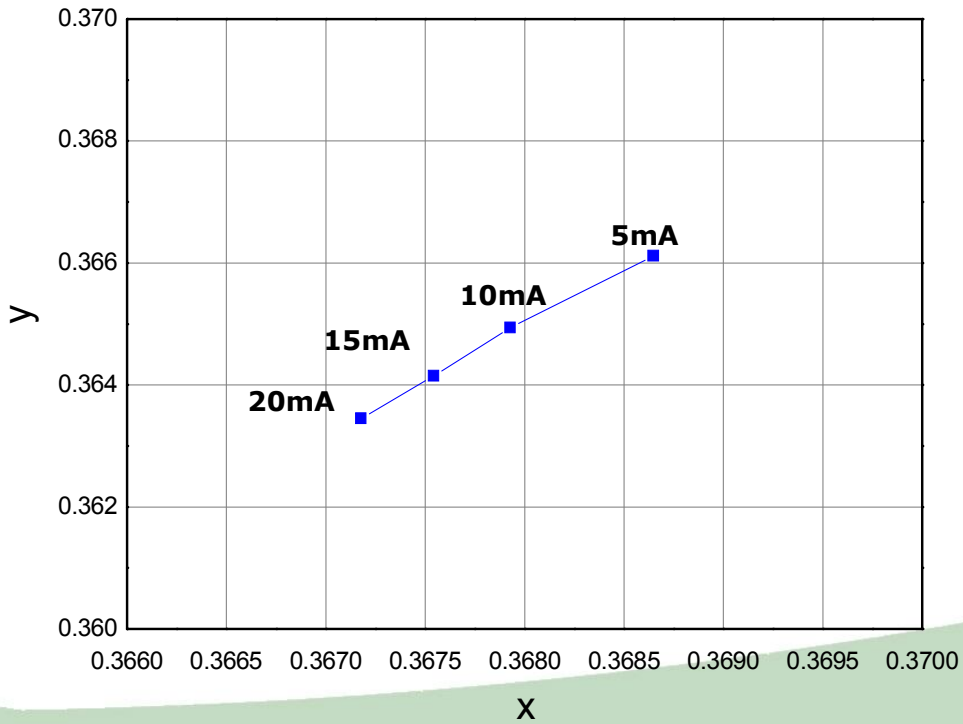

Junction Temperature (°C) - Chromaticity Coordinate characteristics

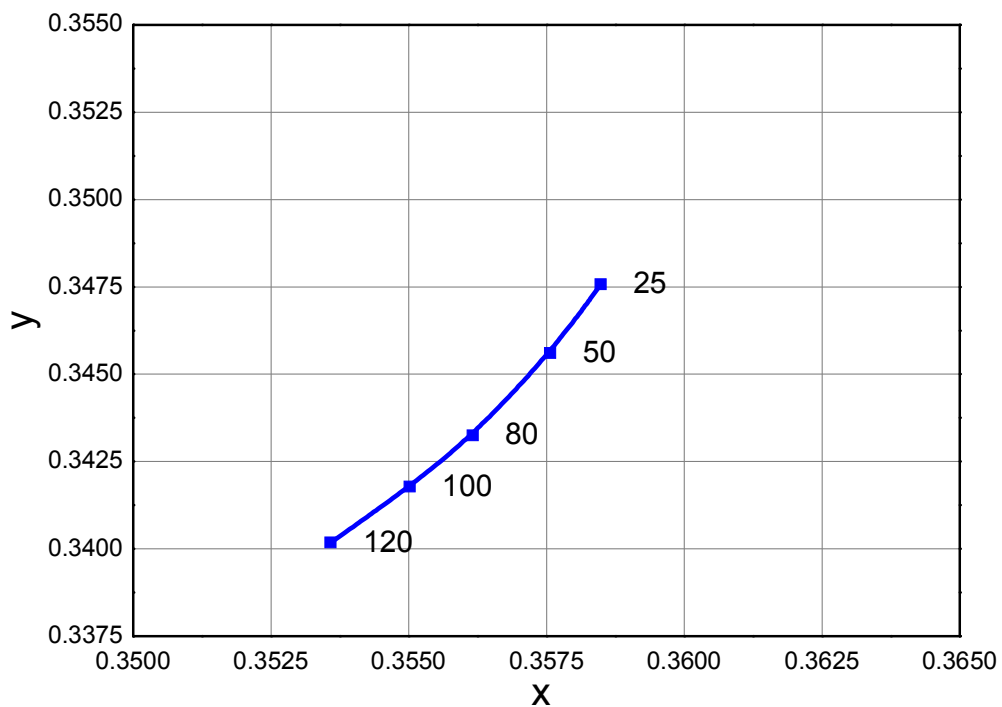

4. Color & binning

1. SAW8P42A

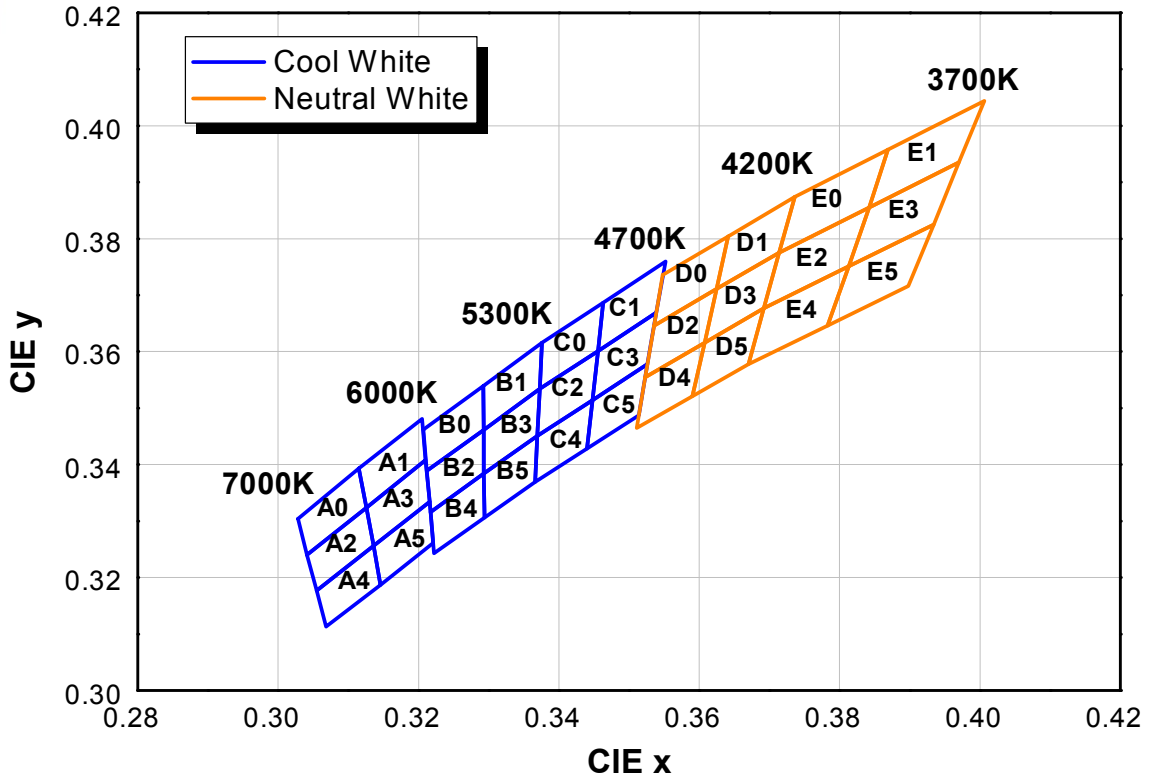

● COLOR RANK

<IF=20mA, Ta=25°C>

6500~7000K					
A0		A2		A4	
CIE X	CIE Y	CIE X	CIE Y	CIE X	CIE Y
0.3028	0.3304	0.3041	0.324	0.3055	0.3177
0.3041	0.324	0.3055	0.3177	0.3068	0.3113
0.3126	0.3324	0.3136	0.3256	0.3146	0.3187
0.3115	0.3393	0.3126	0.3324	0.3136	0.3256
6000~6500K					
A1		A3		A5	
CIE X	CIE Y	CIE X	CIE Y	CIE X	CIE Y
0.3115	0.3393	0.3126	0.3324	0.3136	0.3256
0.3126	0.3324	0.3136	0.3256	0.3146	0.3187
0.321	0.3408	0.3216	0.3334	0.3221	0.3261
0.3205	0.3481	0.321	0.3408	0.3216	0.3334
5600~6000K					
B0		B2		B4	
CIE X	CIE Y	CIE X	CIE Y	CIE X	CIE Y
0.3207	0.3462	0.3212	0.3389	0.3217	0.3316
0.3212	0.3389	0.3217	0.3316	0.3222	0.3243
0.3293	0.3461	0.3293	0.3384	0.3294	0.3306
0.3292	0.3539	0.3293	0.3461	0.3293	0.3384
5300~5600K					
B1		B3		B5	
CIE X	CIE Y	CIE X	CIE Y	CIE X	CIE Y
0.3292	0.3539	0.3293	0.3461	0.3293	0.3384
0.3293	0.3461	0.3293	0.3384	0.3294	0.3306
0.3373	0.3534	0.3369	0.3451	0.3366	0.3369
0.3376	0.3616	0.3373	0.3534	0.3369	0.3451

* Measurement Uncertainty of the Color Coordinates : ± 0.01

● COLOR RANK

<IF=20mA, Ta=25°C>

5000~5300K					
C0		C2		C4	
CIE X	CIE Y	CIE X	CIE Y	CIE X	CIE Y
0.3376	0.3616	0.3373	0.3534	0.3369	0.3451
0.3373	0.3534	0.3369	0.3451	0.3366	0.3369
0.3456	0.3601	0.3448	0.3514	0.344	0.3428
0.3463	0.3687	0.3456	0.3601	0.3448	0.3514
4700~5000K					
C1		C3		C5	
CIE X	CIE Y	CIE X	CIE Y	CIE X	CIE Y
0.3463	0.3687	0.3456	0.3601	0.3448	0.3514
0.3456	0.3601	0.3448	0.3514	0.344	0.3428
0.3539	0.3669	0.3526	0.3578	0.3514	0.3487
0.3552	0.376	0.3539	0.3669	0.3526	0.3578
4500~4700K					
D0		D2		D4	
CIE X	CIE Y	CIE X	CIE Y	CIE X	CIE Y
0.3548	0.3736	0.3536	0.3646	0.3523	0.3555
0.3536	0.3646	0.3523	0.3555	0.3511	0.3465
0.3625	0.3711	0.3608	0.3616	0.359	0.3521
0.3641	0.3804	0.3625	0.3711	0.3608	0.3616
4200~4500K					
D1		D3		D5	
CIE X	CIE Y	CIE X	CIE Y	CIE X	CIE Y
0.3641	0.3804	0.3625	0.3711	0.3608	0.3616
0.3625	0.3711	0.3608	0.3616	0.359	0.3521
0.3714	0.3775	0.3692	0.3677	0.367	0.3578
0.3736	0.3874	0.3714	0.3775	0.3692	0.3677

* Measurement Uncertainty of the Color Coordinates : ± 0.01

● COLOR RANK

<IF=20mA, Ta=25°C>

4000~4200K					
E0		E2		E4	
CIE X	CIE Y	CIE X	CIE Y	CIE X	CIE Y
0.3736	0.3874	0.3714	0.3775	0.3692	0.3677
0.3714	0.3775	0.3692	0.3677	0.367	0.3578
0.3842	0.3855	0.3813	0.3751	0.3783	0.3646
0.3869	0.3958	0.3842	0.3855	0.3813	0.3751
3700~4000K					
E1		E3		E5	
CIE X	CIE Y	CIE X	CIE Y	CIE X	CIE Y
0.3869	0.3958	0.3842	0.3855	0.3813	0.3751
0.3842	0.3855	0.3813	0.3751	0.3783	0.3646
0.397	0.3935	0.3934	0.3825	0.3898	0.3716
0.4006	0.4044	0.397	0.3935	0.3934	0.3825

* Measurement Uncertainty of the Color Coordinates : ± 0.01

5. Bin code description

1. Luminous Intensity Bins

- Luminous Intensity bin structure for Cool white, neutral white, warm white

• **Example**

BIN CODE : **R5**C2B

└───┬───> Luminous Intensity bin

Bin Code	Luminous Intensity [cd]	*[note] Flux (lm)
R5	8.5~9.0	26.4~27.9
S0	9.0~9.5	27.9~29.5
S5	9.5~10.0	29.5~31.0
T0	10.0~10.5	31.0~32.6

[Note] SSC sort the LED package according to the luminous intensity IV.
(The lumen table is only for reference.)

2. Color Rank

white product tested and binned by x,y coordinates and CC

• **Example**

BIN CODE : R5**C2**B

└───┬───> Color bin

[Note] Color Rank @ $I_F = 20\text{mA}$

3. Voltage Bins

• **Example**

BIN CODE : R5C2**B**

└───┬───> Voltage bin

Bin Code	Min.	Max.
A	11.8	12.4
B	12.4	13.0
C	13.0	13.6
D	13.6	14.2

[Note] Forward Voltage (V) @ $I_F = 20\text{mA}$

6. Labeling

Rank : #1#2#3



QUANTITY : 1,500



Lot No : #####



SSC PART NUMBER : **SAW8P42A**



7. Packing

Reel

RANK: XXX
 QUANTITY : XXXX
 LOT NUMBER : XXXXXXXXXXXX
 PART NUMBER : XXXXXX
 SEOUL SEMICONDUCTOR CO., LTD.

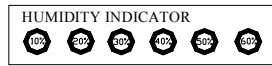
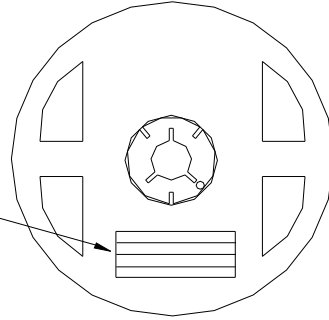

Aluminum Vinyl Bag

RANK: XXX
 QUANTITY : XXXX
 LOT NUMBER : XXXXXXXXXXXX
 PART NUMBER : XXXXXX
 SEOUL SEMICONDUCTOR CO., LTD.

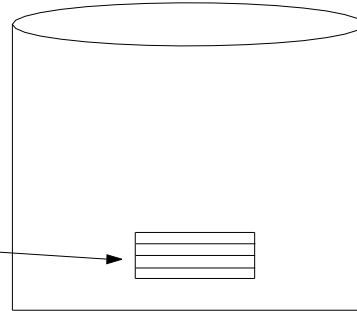

Outer Box Structure

Material : Paper(SW3B(B))

TYPE	SIZE (mm)		
	㉑	㉒	㉓
7inch	245	220	142

㉑ SIDE

RANK: XXX
 QUANTITY : XXXX
 LOT NUMBER : XXXXXXXXXXXX
 PART NUMBER : XXXXXX
 SEOUL SEMICONDUCTOR CO., LTD.

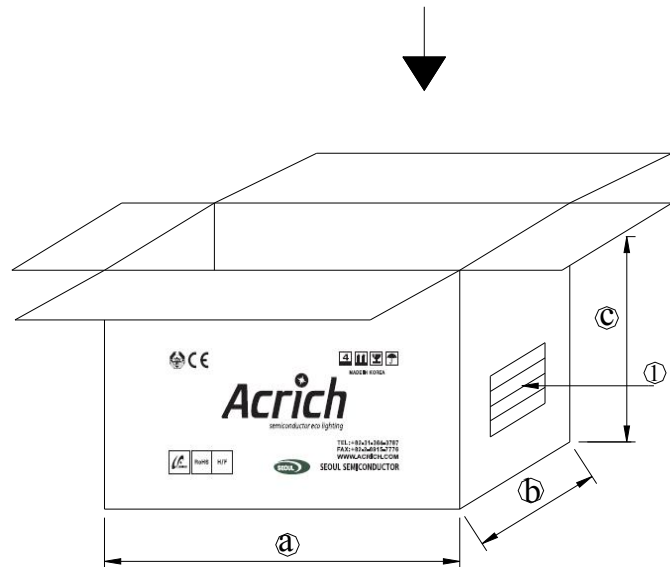

● Reel Packing Structure

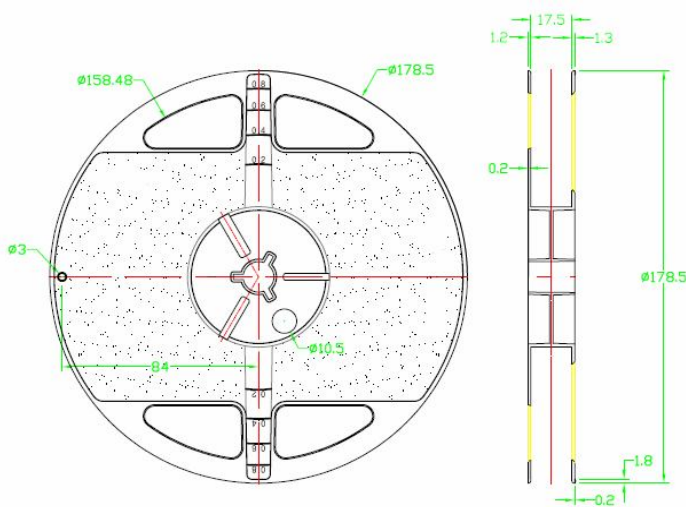
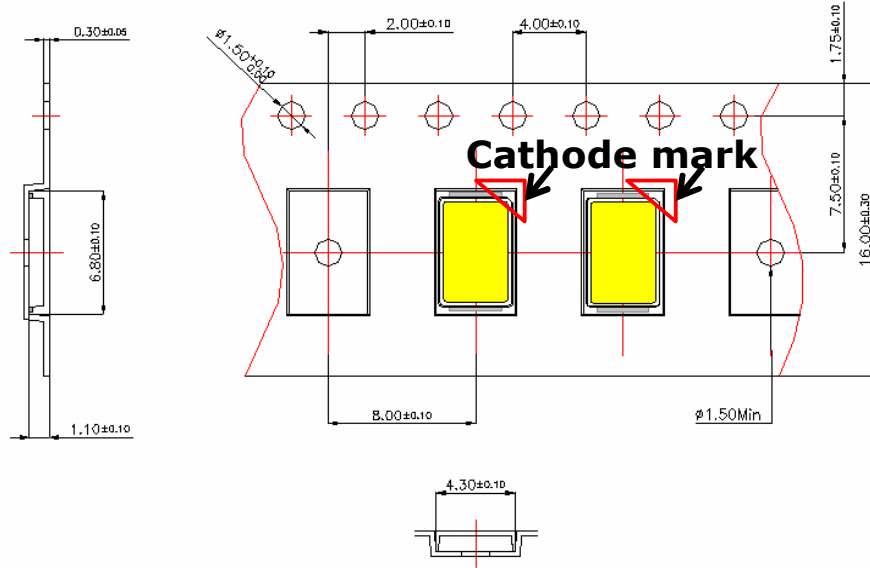

[Tolerance: ±0.2, Unit: mm]

Notes :

- [1] Quantity : 1,500pcs/Reel
- [2] Cumulative Tolerance : Cumulative Tolerance/10 pitches to be ±0.2mm
- [3] Adhesion Strength of Cover Tape : Adhesion strength to be 0.1-0.7N when the cover tape is turned off from the carrier tape at the angle of 10° to the carrier tape
- [4] Package : P/N, Manufacturing data Code No. and quantity to be indicated on a damp proof Package

REV.00
May 2012

www.seoulsemicon.com

8. Recommended solder pad

1. Solder pad

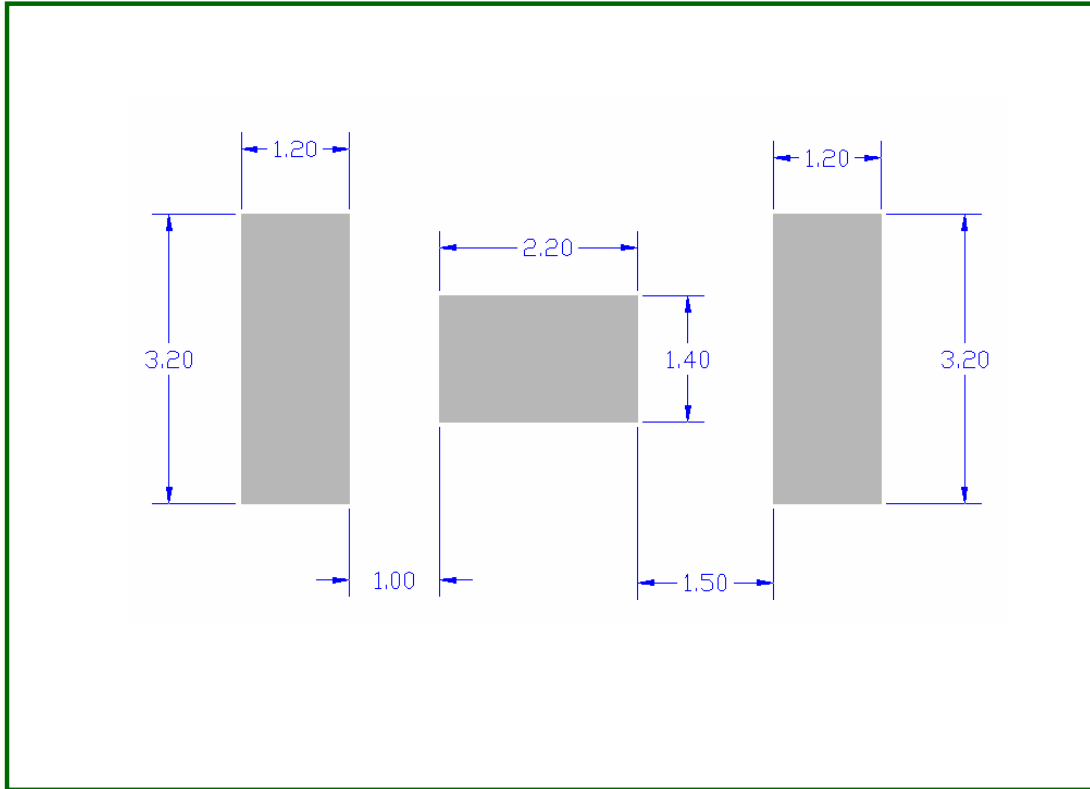

Notes :

- [1] All dimensions are in millimeters.
- [2] Scale : none
- [3] This drawing without tolerances are for reference only

9. Soldering

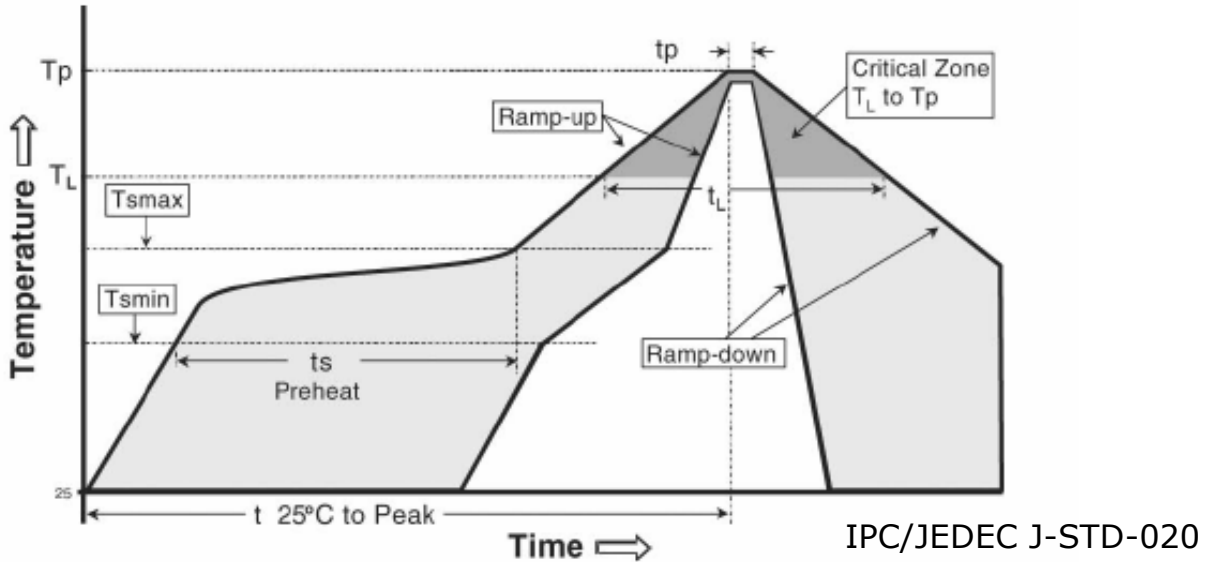

Profile Feature	Sn-Pb Eutectic Assembly	Pb-Free Assembly
Average ramp-up rate (T_{smax} to T_p)	3° C/second max.	3° C/second max.
Preheat - Temperature Min (T _{smin}) - Temperature Max (T _{smax}) - Time (T _{smin} to T _{smax}) (t _s)	100 °C 150 °C 60-120 seconds	150 °C 200 °C 60-180 seconds
Time maintained above: - Temperature (T _L) - Time (t _L)	183 °C 60-150 seconds	217 °C 60-150 seconds
Peak Temperature (T _p)	215 °C	260 °C
Time within 5°C of actual Peak Temperature (t _p) ²	10-30 seconds	20-40 seconds
Ramp-down Rate	6 °C/second max.	6 °C/second max.
Time 25°C to Peak Temperature	6 minutes max.	8 minutes max.

*** Caution**

1. Reflow soldering is recommended not to be done more than two times. In the case of more than 24 hours passed soldering after first, LEDs will be damaged.
2. Repairs should not be done after the LEDs have been soldered. When repair is unavoidable, suitable tools must be used.
3. Die slug is to be soldered.
4. When soldering, do not put stress on the LEDs during heating.
5. After soldering, do not warp the circuit board.

REV.00

May 2012

www.seoulsemicon.com

10. Precaution for use

(1) Storage

To avoid the moisture penetration, we recommend storing SSC LEDs in a dry box with a desiccant . The recommended storage temperature range is 5℃ to 30℃ and a maximum humidity of RH50%.

(2) Use Precaution after Opening the Packaging

Use proper SMD techniques when the LED is to be soldered dipped as separation of the lens may affect the light output efficiency.

Pay attention to the following:

a. Recommend conditions after opening the package

- Sealing

- Temperature : 5 ~ 40℃ Humidity : less than RH30%

b. If the package has been opened more than 4 week(MSL_2a) or the color of the desiccant changes, components should be dried for 10-12hr at 60±5℃

(3) Do not apply mechanical force or excess vibration during the cooling process to normal temperature after soldering.

(4) Do not rapidly cool device after soldering.

(5) Components should not be mounted on warped (non coplanar) portion of PCB.

(6) Radioactive exposure is not considered for the products listed here in.

(7) Gallium arsenide is used in some of the products listed in this publication. These products are dangerous if they are burned or shredded in the process of disposal. It is also dangerous to drink the liquid or inhale the gas generated by such products when chemically disposed of.

(8) This device should not be used in any type of fluid such as water, oil, organic solvent and etc. When washing is required, IPA (Isopropyl Alcohol) should be used.

(9) When the LEDs are in operation the maximum current should be decided after measuring the package temperature.

(10) LEDs must be stored properly to maintain the device. If the LEDs are stored for 3 months or more after being shipped from SSC, a sealed container with a nitrogen atmosphere should be used for storage.

(11) The appearance and specifications of the product may be modified for improvement without notice.

(12) Long time exposure of sunlight or occasional UV exposure will cause lens discoloration.

(13) VOCs (Volatile organic compounds) emitted from materials used in the construction of fixtures can penetrate silicone encapsulants of LEDs and discolor when exposed to heat and photonic energy. The result can be a significant loss of light output from the fixture.

Knowledge of the properties of the materials selected to be used in the construction of fixtures can help prevent these issues.

REV.00

May 2012

www.seoulsemicon.com

11. Handling of Silicone Resin LEDs

(1) During processing, mechanical stress on the surface should be minimized as much as possible. Sharp objects of all types should not be used to pierce the sealing compound.



(2) In general, LEDs should only be handled from the side. By the way, this also applies to LEDs without a silicone sealant, since the surface can also become scratched.

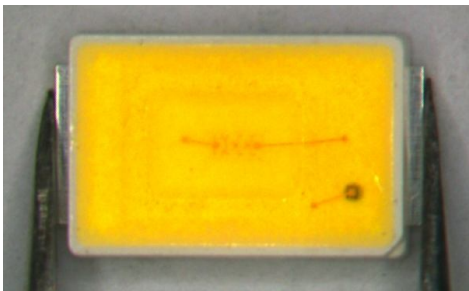

(3) When populating boards in SMT production, there are basically no restrictions regarding the form of the pick and place nozzle, except that mechanical pressure on the surface of the resin must be prevented.

This is assured by choosing a pick and place nozzle which is larger than the LED's reflector area.

(4) Silicone differs from materials conventionally used for the manufacturing of LEDs. These conditions must be considered during the handling of such devices. Compared to standard encapsulants, silicone is generally softer, and the surface is more likely to attract dust.

As mentioned previously, the increased sensitivity to dust requires special care during processing. In cases where a minimal level of dirt and dust particles cannot be guaranteed, a suitable cleaning solution must be applied to the surface after the soldering of components.

(5) SSC suggests using isopropyl alcohol for cleaning. In case other solvents are used, it must be assured that these solvents do not dissolve the package or resin.

Ultrasonic cleaning is not recommended. Ultrasonic cleaning may cause damage to the LED.

(6) Please do not mold this product into another resin (epoxy, urethane, etc) and do not handle this product with acid or sulfur material in sealed space.

(7) Avoid leaving fingerprints on silicone resin parts.

REV.00

May 2012

www.seoulsemicon.com