

## Surface Mount Fast Soft Recovery Rectifier Diode, 20 A

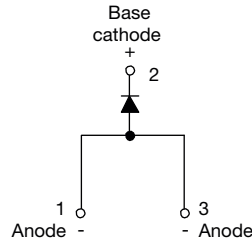

### FEATURES

- Glass passivated pellet chip junction
- Designed and qualified according to JEDEC®-JESD 47
- Meets MSL level 1, per J-STD-020, LF maximum peak of 245 °C
- Material categorization: for definitions of compliance please see [www.vishay.com/doc?99912](http://www.vishay.com/doc?99912)



**RoHS**  
COMPLIANT  
HALOGEN  
**FREE**

### APPLICATIONS

- Output rectification and freewheeling in inverters, choppers and converters
- Input rectifications where severe restrictions on conducted EMI should be met

### DESCRIPTION

The VS-20ETF..S-M3 soft recovery rectifier series has been optimized for combined short reverse recovery time and low forward voltage drop.

The glass passivation ensures stable reliable operation in the most severe temperature and power cycling conditions.

PRIMARY CHARACTERISTICS	
$I_{F(AV)}$	20 A
$V_R$	800 V, 1000 V, 1200 V
$V_F$ at $I_F$	1.31 V
$I_{FSM}$	355 A
$t_{rr}$	95 ns
$T_J$ max.	150 °C
Snap factor	0.6
Package	D <sup>2</sup> PAK (TO-263AB)
Circuit configuration	Single

MAJOR RATINGS AND CHARACTERISTICS			
SYMBOL	CHARACTERISTICS	VALUES	UNITS
$I_{F(AV)}$	Sinusoidal waveform	20	A
$V_{RRM}$		800 to 1200	V
$I_{FSM}$		355	A
$V_F$	20 A, $T_J = 25$ °C	1.31	V
$t_{rr}$	1 A, 100 A/μs	95	ns
$T_J$	Range	-40 to +150	°C

VOLTAGE RATINGS			
PART NUMBER	$V_{RRM}$ , MAXIMUM PEAK REVERSE VOLTAGE V	$V_{RSM}$ , MAXIMUM NON-REPETITIVE PEAK REVERSE VOLTAGE V	$I_{RRM}$ AT 150 °C mA
20ETF08S-M3	800	900	6
20ETF10S-M3	1000	1100	
20ETF12S-M3	1200	1300	

ABSOLUTE MAXIMUM RATINGS				
PARAMETER	SYMBOL	TEST CONDITIONS	VALUES	UNITS
Maximum average forward current	$I_{F(AV)}$	$T_C = 97$ °C, 180° conduction half sine wave	20	A
Maximum peak one cycle non-repetitive surge current	$I_{FSM}$	10 ms sine pulse, rated $V_{RRM}$ applied	300	
		10 ms sine pulse, no voltage reapplied	355	
Maximum $I^2t$ for fusing	$I^2t$	10 ms sine pulse, rated $V_{RRM}$ applied	450	A <sup>2</sup> s
		10 ms sine pulse, no voltage reapplied	635	
Maximum $I^2\sqrt{t}$ for fusing	$I^2\sqrt{t}$	$t = 0.1$ ms to 10 ms, no voltage reapplied	6350	A <sup>2</sup> √s

ELECTRICAL SPECIFICATIONS					
PARAMETER	SYMBOL	TEST CONDITIONS		VALUES	UNITS
Maximum forward voltage drop	$V_{FM}$	20 A, $T_J = 25\text{ }^\circ\text{C}$		1.31	V
Forward slope resistance	$r_t$	$T_J = 150\text{ }^\circ\text{C}$		11.88	$m\Omega$
Threshold voltage	$V_{F(TO)}$			0.93	V
Maximum reverse leakage current	$I_{RM}$	$T_J = 25\text{ }^\circ\text{C}$	$V_R = \text{rated } V_{RRM}$	0.1	mA
		$T_J = 150\text{ }^\circ\text{C}$		6	

RECOVERY CHARACTERISTICS				
PARAMETER	SYMBOL	TEST CONDITIONS	VALUES	UNITS
Reverse recovery time	$t_{rr}$	$I_F$ at 20 A <sub>pk</sub> 25 A/ $\mu$ s 25 $^\circ\text{C}$	400	ns
Reverse recovery current	$I_{rr}$		6.1	A
Reverse recovery charge	$Q_{rr}$		1.7	$\mu\text{C}$
Snap factor	S	Typical	0.6	

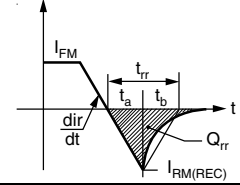

THERMAL - MECHANICAL SPECIFICATIONS				
PARAMETER	SYMBOL	TEST CONDITIONS	VALUES	UNITS
Maximum junction and storage temperature range	$T_J, T_{Stg}$		-40 to +150	$^\circ\text{C}$
Maximum thermal resistance, junction to case	$R_{thJC}$	DC operation	0.9	$^\circ\text{C/W}$
Maximum thermal resistance, junction to ambient (PCB mount)	$R_{thJA}^{(1)}$		62	
Approximate weight			2	g
			0.07	oz.
Marking device		Case style D <sup>2</sup> PAK (TO-263AB)	20ETF08S	
			20ETF10S	
			20ETF12S	

**Note**

- (1) When mounted on 1" square (650 mm<sup>2</sup>) PCB of FR-4 or G-10 material 4 oz. (140  $\mu$ m) copper 40  $^\circ\text{C/W}$ . For recommended footprint and soldering techniques refer to application note #AN-994

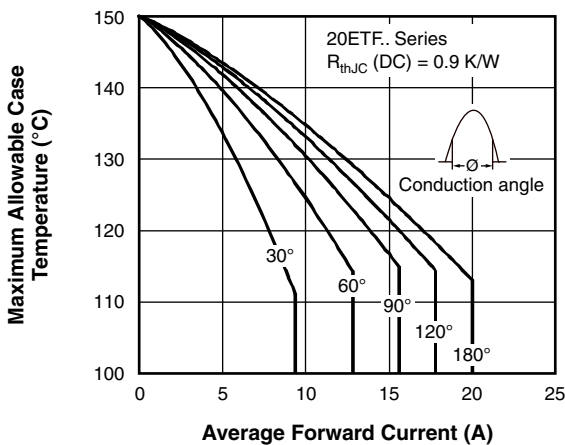

Fig. 1 - Current Rating Characteristics

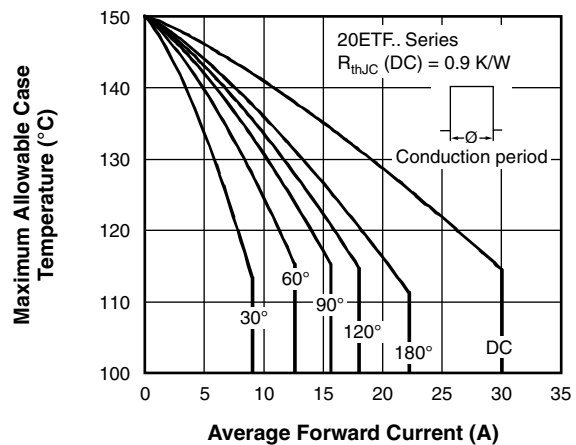

Fig. 2 - Current Rating Characteristics

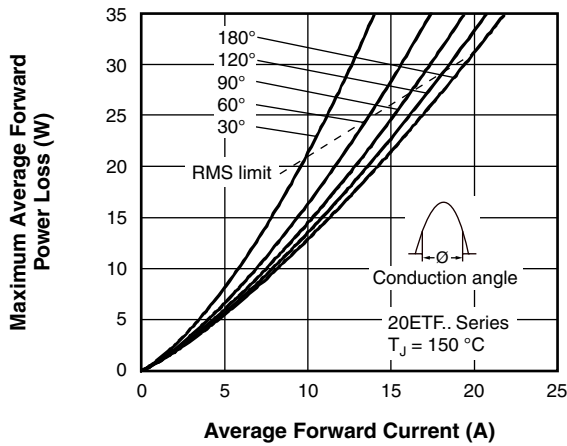

Fig. 3 - Forward Power Loss Characteristics

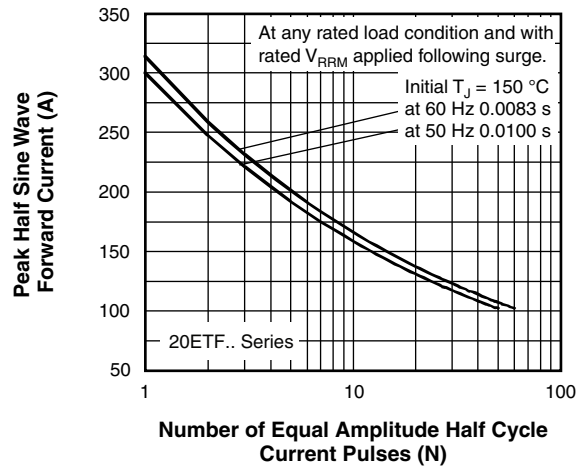

Fig. 5 - Maximum Non-Repetitive Surge Current

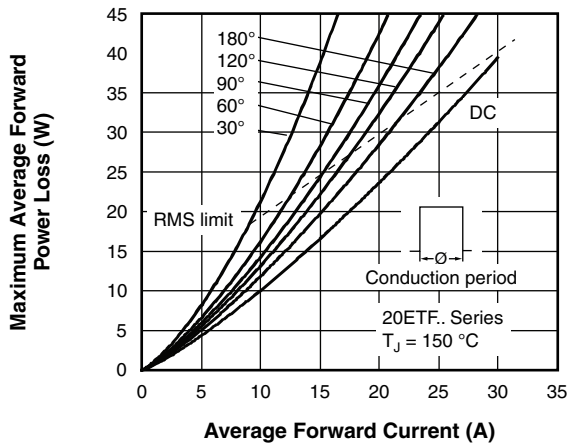

Fig. 4 - Forward Power Loss Characteristics

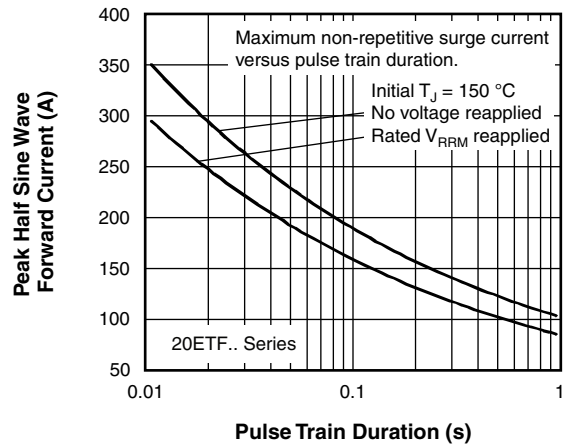

Fig. 6 - Maximum Non-Repetitive Surge Current

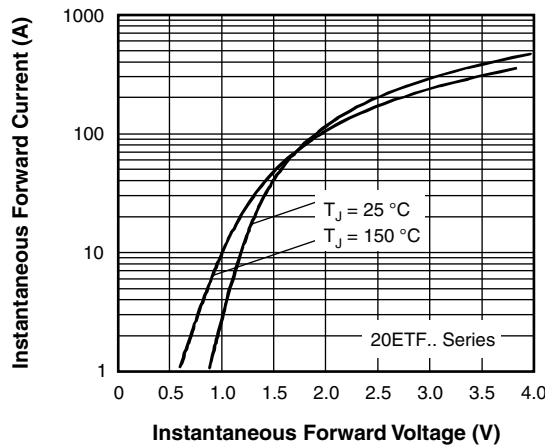

Fig. 7 - Forward Voltage Drop Characteristics

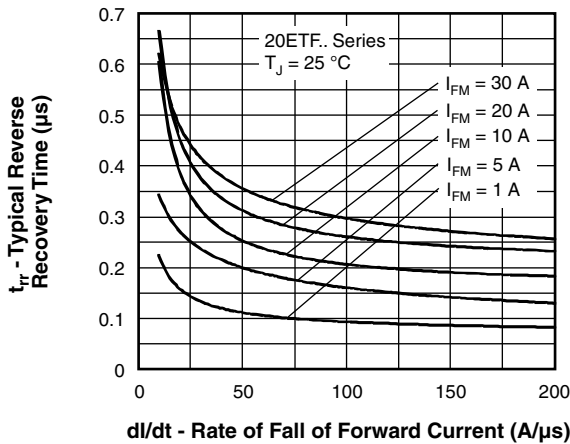

Fig. 8 - Recovery Time Characteristics, T<sub>J</sub> = 25 °C

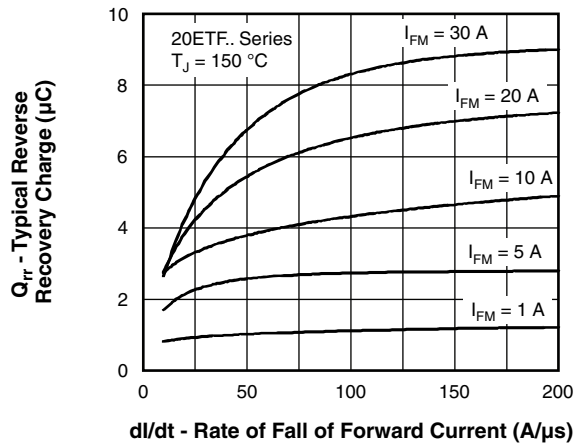

Fig. 11 - Recovery Charge Characteristics, T<sub>J</sub> = 150 °C

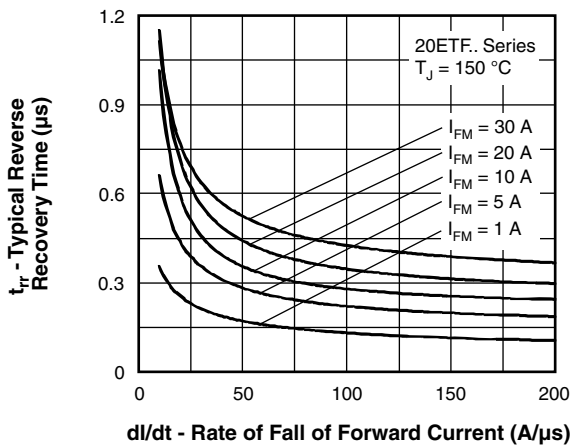

Fig. 9 - Recovery Time Characteristics, T<sub>J</sub> = 150 °C

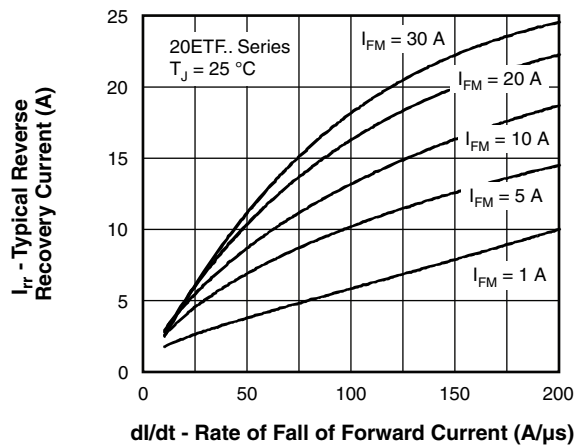

Fig. 12 - Recovery Current Characteristics, T<sub>J</sub> = 25 °C

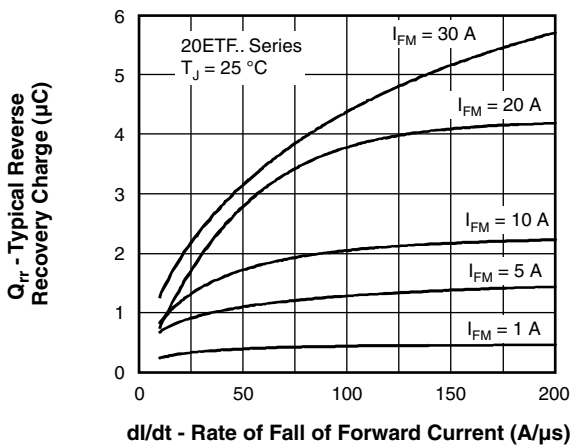

Fig. 10 - Recovery Charge Characteristics, T<sub>J</sub> = 25 °C

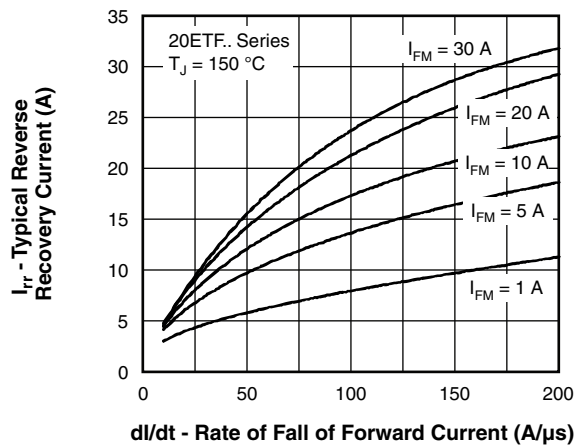

Fig. 13 - Recovery Current Characteristics, T<sub>J</sub> = 150 °C

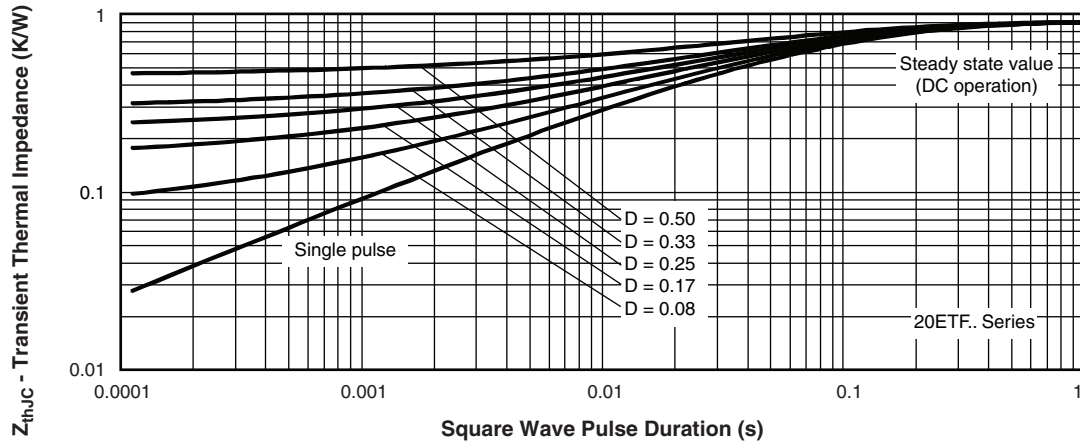

Fig. 14 - Thermal Impedance  $Z_{thJC}$  Characteristics

**ORDERING INFORMATION TABLE**

Device code	<b>VS-</b>	<b>20</b>	<b>E</b>	<b>T</b>	<b>F</b>	<b>12</b>	<b>S</b>	<b>TRL</b>	<b>-M3</b>
	1	2	3	4	5	6	7	8	9

- 1** - Vishay Semiconductors product
- 2** - Current rating (20 = 20 A)
- 3** - Circuit configuration:  
E = single
- 4** - Package:  
T = D<sup>2</sup>PAK (TO-263AB)
- 5** - Type of silicon:  
F = fast soft recovery rectifier
- 6** - Voltage code x 100 =  $V_{RRM}$ 

08 = 800 V
10 = 1000 V
12 = 1200 V
- 7** - S = surface mountable
- 8** -
  - None = tape
  - TRR = tape and reel (right oriented)
  - TRL = tape and reel (left oriented)
- 9** - -M3 = halogen-free, RoHS-compliant, and terminations lead (Pb)-free



<b>ORDERING INFORMATION</b> (Example)			
<b>PREFERRED P/N</b>	<b>QUANTITY PER T/R</b>	<b>MINIMUM ORDER QUANTITY</b>	<b>PACKAGING DESCRIPTION</b>
VS-20ETF08S-M3	50	1000	Antistatic plastic tubes
VS-20ETF08STRR-M3	800	800	13" diameter reel
VS-20ETF08STRL-M3	800	800	13" diameter reel
VS-20ETF10S-M3	50	1000	Antistatic plastic tubes
VS-20ETF10STRR-M3	800	800	13" diameter reel
VS-20ETF10STRL-M3	800	800	13" diameter reel
VS-20ETF12S-M3	50	1000	Antistatic plastic tubes
VS-20ETF12STRR-M3	800	800	13" diameter reel
VS-20ETF12STRL-M3	800	800	13" diameter reel

<b>LINKS TO RELATED DOCUMENTS</b>	
Dimensions	<a href="http://www.vishay.com/doc?96164">www.vishay.com/doc?96164</a>
Part marking information	<a href="http://www.vishay.com/doc?95444">www.vishay.com/doc?95444</a>
Packaging information	<a href="http://www.vishay.com/doc?96424">www.vishay.com/doc?96424</a>



## D<sup>2</sup>PAK

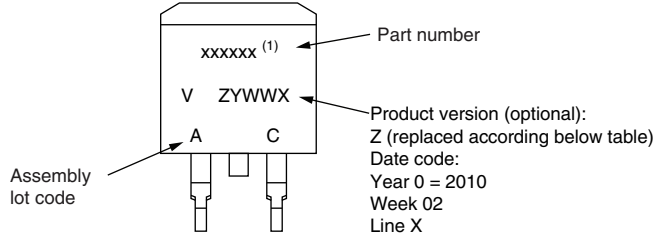

Example: This is a xxxxxx <sup>(1)</sup> with assembly lot code AC, assembled on WW 02, 2010

### Note

<sup>(1)</sup> If part number contain "H" as last digit, product is AEC-Q101 qualified

ENVIRONMENTAL NAMING CODE (Z)	PRODUCT DEFINITION
A	Termination lead (Pb)-free
B	Totally lead (Pb)-free
E	RoHS-compliant and termination lead (Pb)-free
F	RoHS-compliant and totally lead (Pb)-free
M	Halogen-free, RoHS-compliant, and termination lead (Pb)-free
N	Halogen-free, RoHS-compliant, and totally lead (Pb)-free
G	Green

## D<sup>2</sup>PAK

**DIMENSIONS** in millimeters and inches

Conforms to JEDEC® outline D<sup>2</sup>PAK (SMD-220)

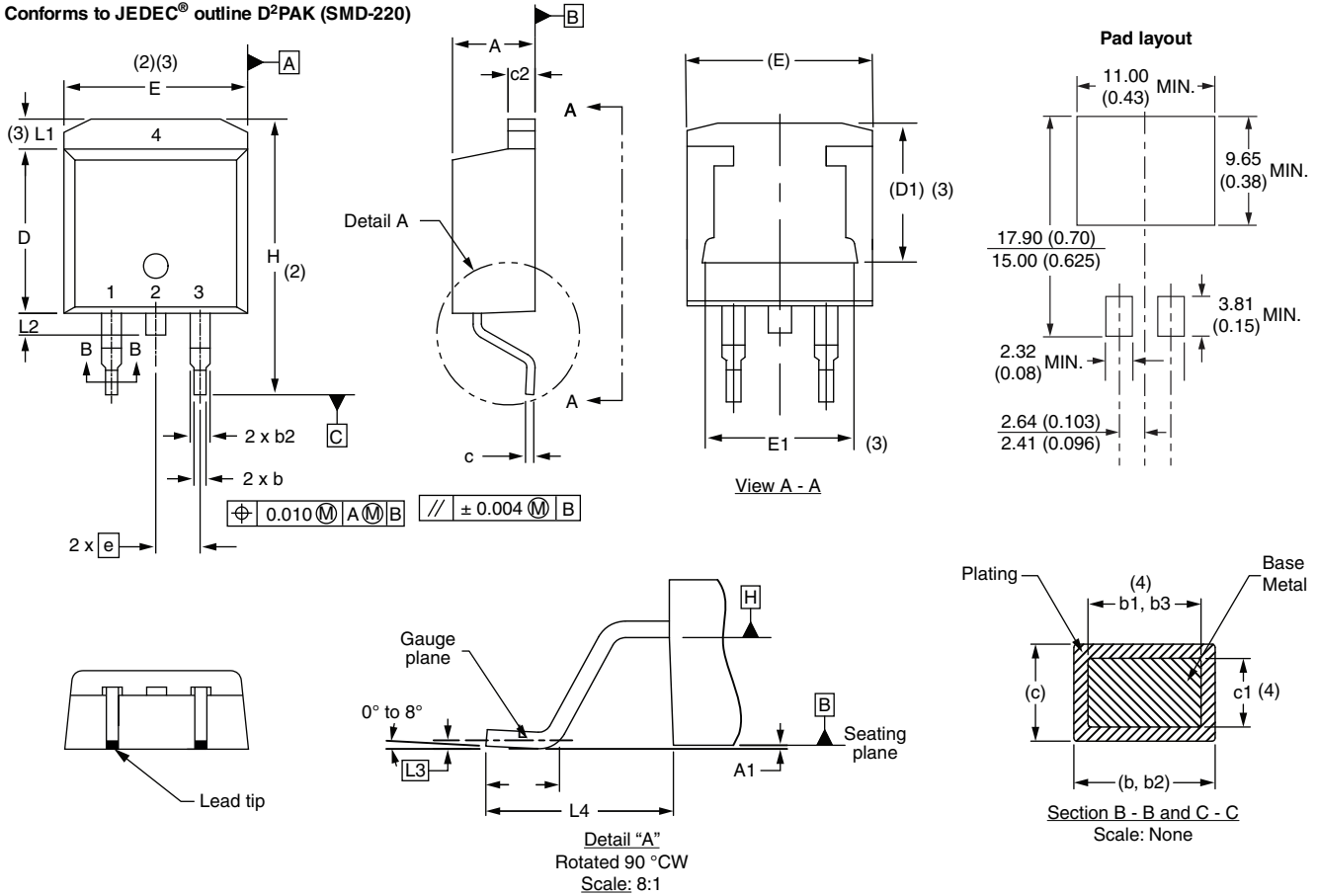

SYMBOL	MILLIMETERS		INCHES		NOTES	SYMBOL	MILLIMETERS		INCHES		NOTES
	MIN.	MAX.	MIN.	MAX.			MIN.	MAX.	MIN.	MAX.	
A	4.06	4.83	0.160	0.190		D1	6.86	8.00	0.270	0.315	3
A1	0.00	0.254	0.000	0.010		E	9.65	10.67	0.380	0.420	2, 3
b	0.51	0.99	0.020	0.039		E1	7.90	8.80	0.311	0.346	3
b1	0.51	0.89	0.020	0.035	4	e	2.54 BSC		0.100 BSC		
b2	1.14	1.78	0.045	0.070		H	14.61	15.88	0.575	0.625	
b3	1.14	1.73	0.045	0.068	4	L	1.78	2.79	0.070	0.110	
c	0.38	0.74	0.015	0.029		L1	-	1.65	-	0.066	3
c1	0.38	0.58	0.015	0.023	4	L2	1.27	1.78	0.050	0.070	
c2	1.14	1.65	0.045	0.065		L3	0.25 BSC		0.010 BSC		
D	8.51	9.65	0.335	0.380	2	L4	4.78	5.28	0.188	0.208	

**Notes**

- (1) Dimensioning and tolerancing per ASME Y14.5 M-1994
- (2) Dimension D and E do not include mold flash. Mold flash shall not exceed 0.127 mm (0.005") per side. These dimensions are measured at the outmost extremes of the plastic body
- (3) Thermal pad contour optional within dimension E, L1, D1 and E1
- (4) Dimension b1 and c1 apply to base metal only
- (5) Datum A and B to be determined at datum plane H
- (6) Controlling dimension: inches
- (7) Outline conforms to JEDEC® outline TO-263AB





# D<sup>2</sup>PAK (TO-263AB)

## CARRIER TAPE FOR TAPE AND REEL LEFT in millimeters

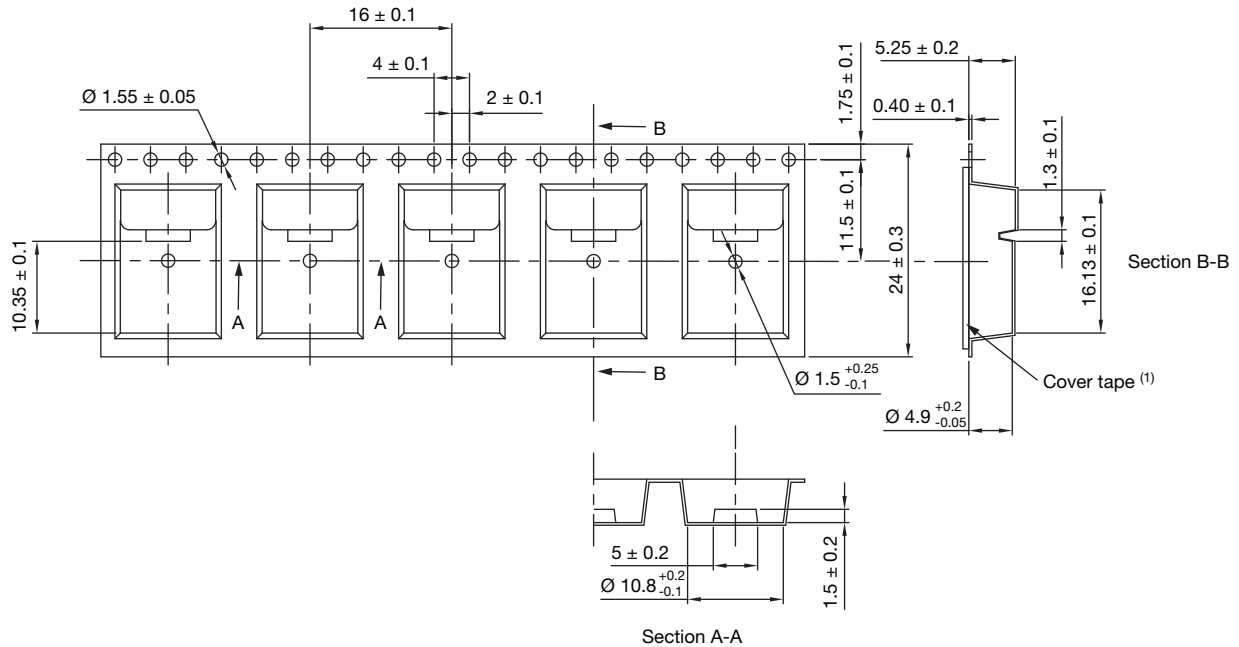

**Note**

(1) For dimensions, see next pages

## CARRIER TAPE FOR TAPE AND REEL RIGHT in millimeters

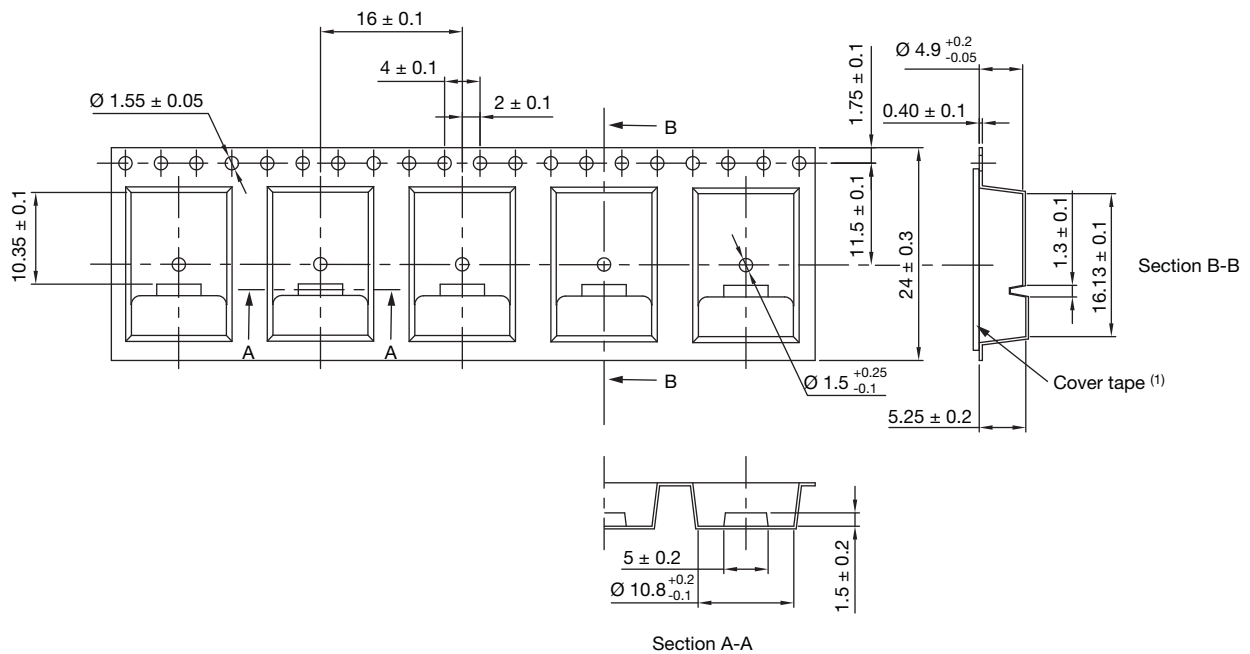

**Note**

(1) For dimensions, see next pages



### REEL FOR CARRIER TAPE in millimeters

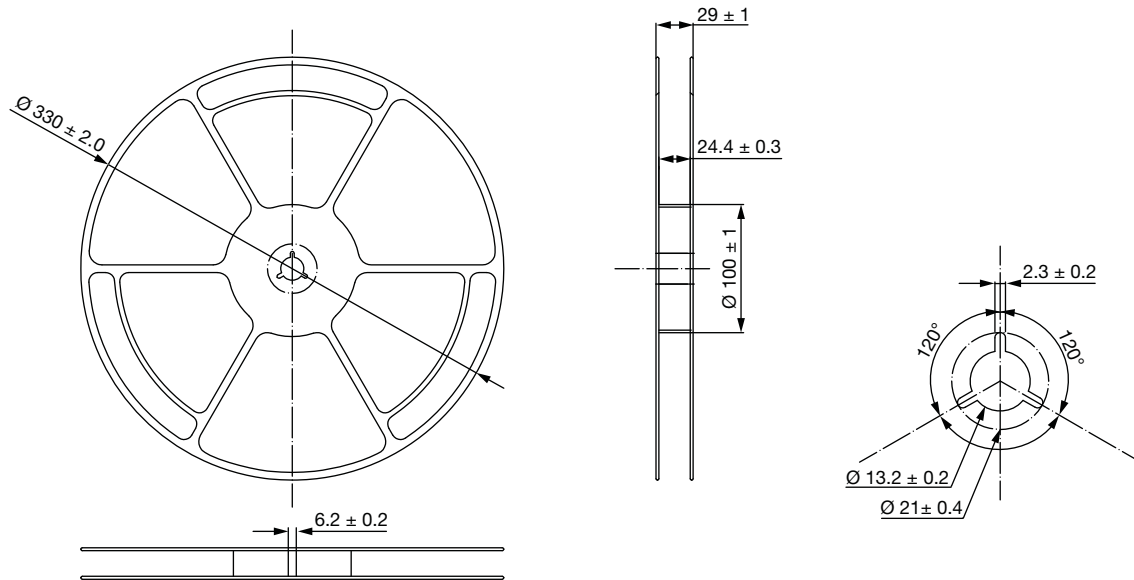

### CARRIER TAPE AND REEL PACKAGING D<sup>2</sup>PAK (TO-263AB)

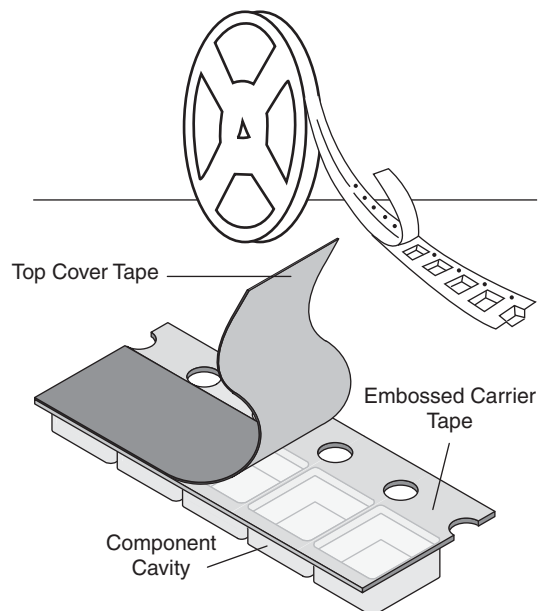



### COVER TAPE FOR CARRIER TAPE in millimeters

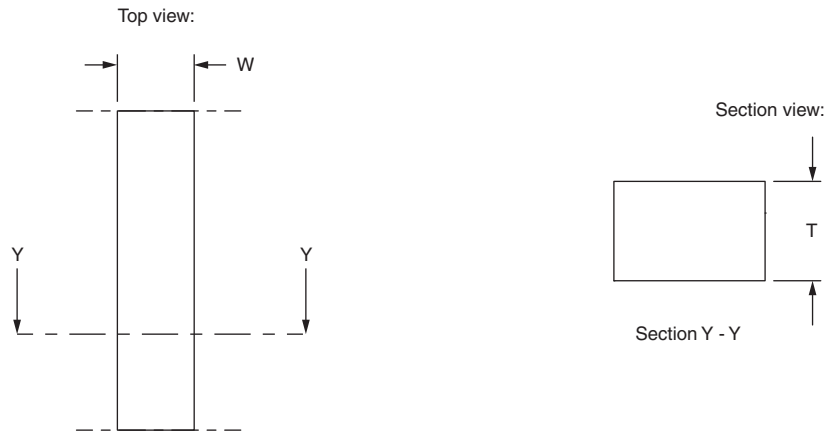

APPLICATION	COVER TAPE WIDTH W	COVER TAPE THICKNESS T	CARRIER TAPE WIDTH	MATERIAL
D <sup>2</sup> PAK (TO-263AB)	21.3 ± 0.1	0.060 ± 0.01	24	Antistatic/treated/transparent/polyester



## **Disclaimer**

ALL PRODUCT, PRODUCT SPECIFICATIONS AND DATA ARE SUBJECT TO CHANGE WITHOUT NOTICE TO IMPROVE RELIABILITY, FUNCTION OR DESIGN OR OTHERWISE.

Vishay Intertechnology, Inc., its affiliates, agents, and employees, and all persons acting on its or their behalf (collectively, "Vishay"), disclaim any and all liability for any errors, inaccuracies or incompleteness contained in any datasheet or in any other disclosure relating to any product.

Vishay makes no warranty, representation or guarantee regarding the suitability of the products for any particular purpose or the continuing production of any product. To the maximum extent permitted by applicable law, Vishay disclaims (i) any and all liability arising out of the application or use of any product, (ii) any and all liability, including without limitation special, consequential or incidental damages, and (iii) any and all implied warranties, including warranties of fitness for particular purpose, non-infringement and merchantability.

Statements regarding the suitability of products for certain types of applications are based on Vishay's knowledge of typical requirements that are often placed on Vishay products in generic applications. Such statements are not binding statements about the suitability of products for a particular application. It is the customer's responsibility to validate that a particular product with the properties described in the product specification is suitable for use in a particular application. Parameters provided in datasheets and / or specifications may vary in different applications and performance may vary over time. All operating parameters, including typical parameters, must be validated for each customer application by the customer's technical experts. Product specifications do not expand or otherwise modify Vishay's terms and conditions of purchase, including but not limited to the warranty expressed therein.

Except as expressly indicated in writing, Vishay products are not designed for use in medical, life-saving, or life-sustaining applications or for any other application in which the failure of the Vishay product could result in personal injury or death. Customers using or selling Vishay products not expressly indicated for use in such applications do so at their own risk. Please contact authorized Vishay personnel to obtain written terms and conditions regarding products designed for such applications.

No license, express or implied, by estoppel or otherwise, to any intellectual property rights is granted by this document or by any conduct of Vishay. Product names and markings noted herein may be trademarks of their respective owners.