

# NTMS3P03R2

## Power MOSFET -3.05 Amps, -30 Volts

### P-Channel SOIC-8

#### Features

- High Efficiency Components in a Single SOIC-8 Package
- High Density Power MOSFET with Low  $R_{DS(on)}$
- Miniature SOIC-8 Surface Mount Package - Saves Board Space
- Diode Exhibits High Speed with Soft Recovery
- $I_{DSS}$  Specified at Elevated Temperature
- Avalanche Energy Specified
- Mounting Information for the SOIC-8 Package is Provided
- Pb-Free Package is Available

#### Applications

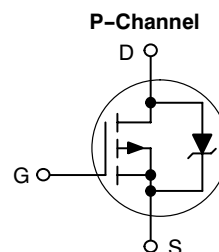
- DC-DC Converters
- Low Voltage Motor Control
- Power Management in Portable and Battery-Powered Products, i.e.: Computers, Printers, PCMCIA Cards, Cellular & Cordless Telephones



ON Semiconductor®

<http://onsemi.com>

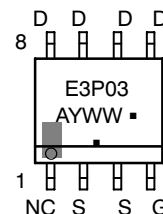
**-3.05 AMPERES**  
**-30 VOLTS**  
**0.085  $\Omega$  @  $V_{GS} = -10 V$**



#### MARKING DIAGRAM & PIN ASSIGNMENT



SOIC-8  
CASE 751  
STYLE 13



E3P03 = Specific Device Code  
A = Assembly Location  
Y = Year  
WW = Work Week  
▪ = Pb-Free Package

(Note: Microdot may be in either location)

#### ORDERING INFORMATION

Device	Package	Shipping†
NTMS3P03R2	SOIC-8	2500/Tape & Reel
NTMS3P03R2G	SOIC-8 (Pb-Free)	2500/Tape & Reel

†For information on tape and reel specifications, including part orientation and tape sizes, please refer to our Tape and Reel Packaging Specification Brochure, BRD8011/D.

# NTMS3P03R2

## MAXIMUM RATINGS

Rating	Symbol	Value	Unit
Drain-to-Source Voltage	$V_{DSS}$	-30	V
Gate-to-Source Voltage - Continuous	$V_{GS}$	$\pm 20$	V
Thermal Resistance - Junction-to-Ambient (Note 1) Total Power Dissipation @ $T_A = 25^\circ\text{C}$ Continuous Drain Current @ $25^\circ\text{C}$ Continuous Drain Current @ $70^\circ\text{C}$ Pulsed Drain Current (Note 4)	$R_{\theta JA}$ $P_D$ $I_D$ $I_D$ $I_{DM}$	171 0.73 -2.34 -1.87 -8.0	$^\circ\text{C/W}$ W A A A
Thermal Resistance - Junction-to-Ambient (Note 2) Total Power Dissipation @ $T_A = 25^\circ\text{C}$ Continuous Drain Current @ $25^\circ\text{C}$ Continuous Drain Current @ $70^\circ\text{C}$ Pulsed Drain Current (Note 4)	$R_{\theta JA}$ $P_D$ $I_D$ $I_D$ $I_{DM}$	100 1.25 -3.05 -2.44 -12	$^\circ\text{C/W}$ W A A A
Thermal Resistance - Junction-to-Ambient (Note 3) Total Power Dissipation @ $T_A = 25^\circ\text{C}$ Continuous Drain Current @ $25^\circ\text{C}$ Continuous Drain Current @ $70^\circ\text{C}$ Pulsed Drain Current (Note 4)	$R_{\theta JA}$ $P_D$ $I_D$ $I_D$ $I_{DM}$	62.5 2.0 -3.86 -3.1 -15	$^\circ\text{C/W}$ W A A A
Operating and Storage Temperature Range	$T_J, T_{stg}$	-55 to +150	$^\circ\text{C}$
Single Pulse Drain-to-Source Avalanche Energy - Starting $T_J = 25^\circ\text{C}$ ( $V_{DD} = -30\text{ Vdc}$ , $V_{GS} = -4.5\text{ Vdc}$ , Peak $I_L = -7.5\text{ Apk}$ , $L = 5\text{ mH}$ , $R_G = 25\ \Omega$ )	$E_{AS}$	140	mJ
Maximum Lead Temperature for Soldering Purposes, 1/8" from case for 10 seconds	$T_L$	260	$^\circ\text{C}$

Stresses exceeding Maximum Ratings may damage the device. Maximum Ratings are stress ratings only. Functional operation above the Recommended Operating Conditions is not implied. Extended exposure to stresses above the Recommended Operating Conditions may affect device reliability.

1. Minimum FR-4 or G-10 PCB,  $t = \text{steady state}$ .
2. Mounted onto a 2" square FR-4 Board (1" sq. 2 oz Cu 0.06" thick single sided),  $t = \text{steady state}$ .
3. Mounted onto a 2" square FR-4 Board (1" sq. 2 oz Cu 0.06" thick single sided),  $t \leq 10\text{ seconds}$ .
4. Pulse Test: Pulse Width = 300  $\mu\text{s}$ , Duty Cycle = 2%.

# NTMS3P03R2

## ELECTRICAL CHARACTERISTICS (T<sub>J</sub> = 25°C unless otherwise noted) (Note 5)

Characteristic	Symbol	Min	Typ	Max	Unit
----------------	--------	-----	-----	-----	------

### OFF CHARACTERISTICS

Drain-to-Source Breakdown Voltage (V <sub>GS</sub> = 0 Vdc, I <sub>D</sub> = -250 μAdc) Temperature Coefficient (Positive)	V <sub>(BR)DSS</sub>	-30 -	- -30	- -	Vdc mV/°C
Zero Gate Voltage Drain Current (V <sub>DS</sub> = -30 Vdc, V <sub>GS</sub> = 0 Vdc, T <sub>J</sub> = 25°C) (V <sub>DS</sub> = -30 Vdc, V <sub>GS</sub> = 0 Vdc, T <sub>J</sub> = 125°C)	I <sub>DSS</sub>	- -	- -	-1.0 -10	μAdc
Gate-Body Leakage Current (V <sub>GS</sub> = -20 Vdc, V <sub>DS</sub> = 0 Vdc)	I <sub>GSS</sub>	-	-	-100	nAdc
Gate-Body Leakage Current (V <sub>GS</sub> = +20 Vdc, V <sub>DS</sub> = 0 Vdc)	I <sub>GSS</sub>	-	-	100	nAdc

### ON CHARACTERISTICS

Gate Threshold Voltage (V <sub>DS</sub> = V <sub>GS</sub> , I <sub>D</sub> = -250 μAdc) Temperature Coefficient (Negative)	V <sub>GS(th)</sub>	-1.0 -	-1.7 3.6	-2.5 -	Vdc
Static Drain-to-Source On-State Resistance (V <sub>GS</sub> = -10 Vdc, I <sub>D</sub> = -3.05 Adc) (V <sub>GS</sub> = -4.5 Vdc, I <sub>D</sub> = -1.5 Adc)	R <sub>DS(on)</sub>	- -	0.063 0.090	0.085 0.115	Ω
Forward Transconductance (V <sub>DS</sub> = -15 Vdc, I <sub>D</sub> = -3.05 Adc)	g <sub>FS</sub>	-	5.0	-	Mhos

### DYNAMIC CHARACTERISTICS

Input Capacitance	(V <sub>DS</sub> = -24 Vdc, V <sub>GS</sub> = 0 Vdc, f = 1.0 MHz)	C <sub>iss</sub>	-	520	750	pF
Output Capacitance		C <sub>oss</sub>	-	170	325	
Reverse Transfer Capacitance		C <sub>rss</sub>	-	70	135	

### SWITCHING CHARACTERISTICS (Notes 6 & 7)

Turn-On Delay Time	(V <sub>DD</sub> = -24 Vdc, I <sub>D</sub> = -3.05 Adc, V <sub>GS</sub> = -10 Vdc, R <sub>G</sub> = 6.0 Ω)	t <sub>d(on)</sub>	-	12	22	ns
Rise Time		t <sub>r</sub>	-	16	30	
Turn-Off Delay Time		t <sub>d(off)</sub>	-	45	80	
Fall Time		t <sub>f</sub>	-	45	80	
Turn-On Delay Time	(V <sub>DD</sub> = -24 Vdc, I <sub>D</sub> = -1.5 Adc, V <sub>GS</sub> = -4.5 Vdc, R <sub>G</sub> = 6.0 Ω)	t <sub>d(on)</sub>	-	16	-	ns
Rise Time		t <sub>r</sub>	-	42	-	
Turn-Off Delay Time		t <sub>d(off)</sub>	-	32	-	
Fall Time		t <sub>f</sub>	-	35	-	
Total Gate Charge	(V <sub>DS</sub> = -24 Vdc, V <sub>GS</sub> = -10 Vdc, I <sub>D</sub> = -3.05 Adc)	Q <sub>tot</sub>	-	16	25	nC
Gate-Source Charge		Q <sub>gs</sub>	-	2.0	-	
Gate-Drain Charge		Q <sub>gd</sub>	-	4.5	-	

### BODY-DRAIN DIODE RATINGS (Note 6)

Diode Forward On-Voltage	(I <sub>S</sub> = -3.05 Adc, V <sub>GS</sub> = 0 V) (I <sub>S</sub> = -3.05 Adc, V <sub>GS</sub> = 0 V, T <sub>J</sub> = 125°C)	V <sub>SD</sub>	- -	-0.96 -0.78	-1.25 -	Vdc
Reverse Recovery Time	(I <sub>S</sub> = -3.05 Adc, V <sub>GS</sub> = 0 Vdc, dI <sub>S</sub> /dt = 100 A/μs)	t <sub>rr</sub>	-	34	-	ns
		t <sub>a</sub>	-	18	-	
		t <sub>b</sub>	-	16	-	
Reverse Recovery Stored Charge		Q <sub>RR</sub>	-	0.03	-	μC

5. Handling precautions to protect against electrostatic discharge is mandatory.
6. Indicates Pulse Test: Pulse Width = 300 μs max, Duty Cycle = 2%.
7. Switching characteristics are independent of operating junction temperature.

TYPICAL ELECTRICAL CHARACTERISTICS

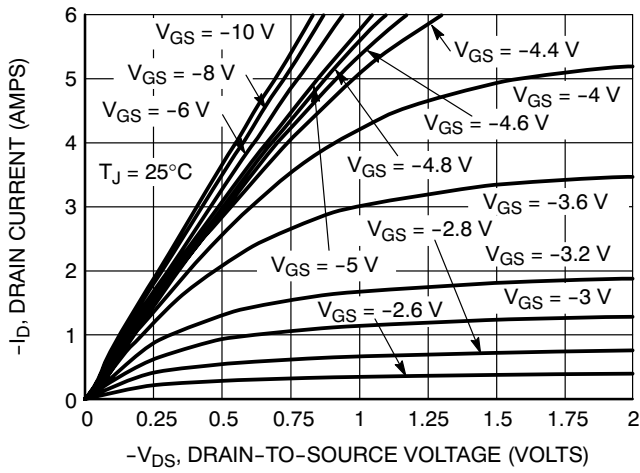


Figure 1. On-Region Characteristics

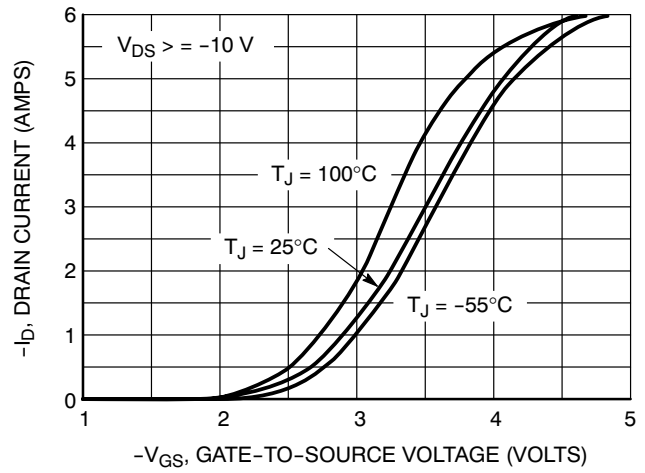


Figure 2. Transfer Characteristics

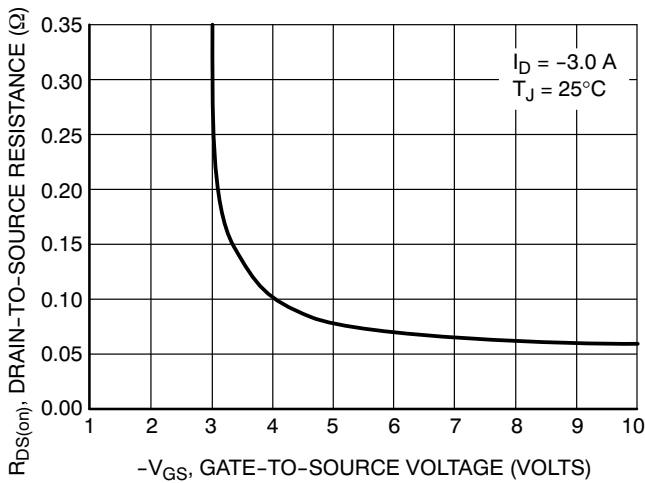


Figure 3. On-Resistance vs. Gate-to-Source Voltage

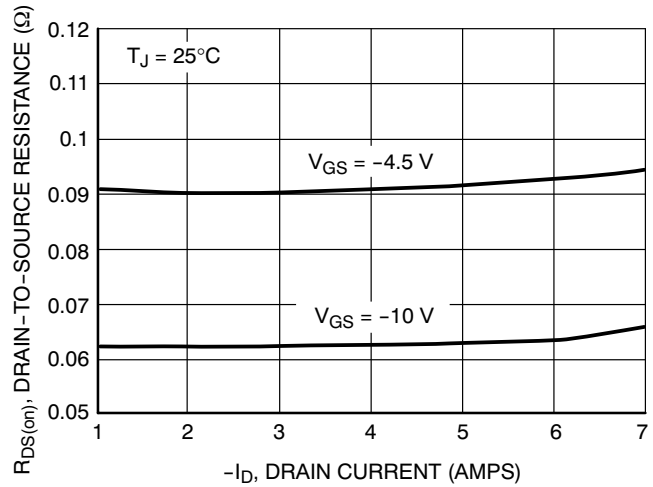


Figure 4. On-Resistance vs. Drain Current and Gate Voltage

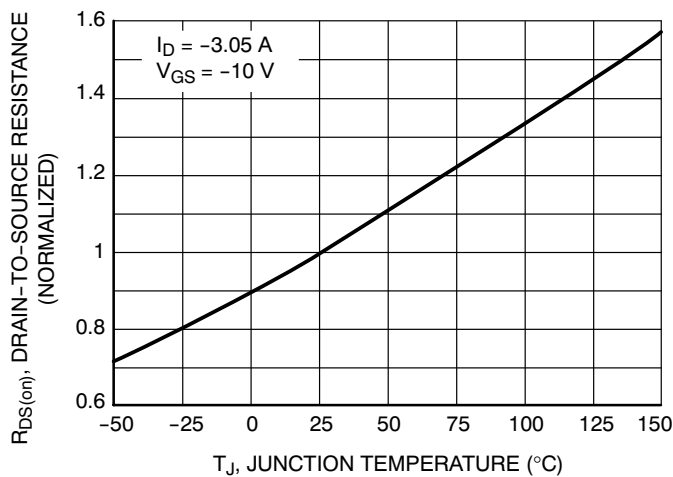
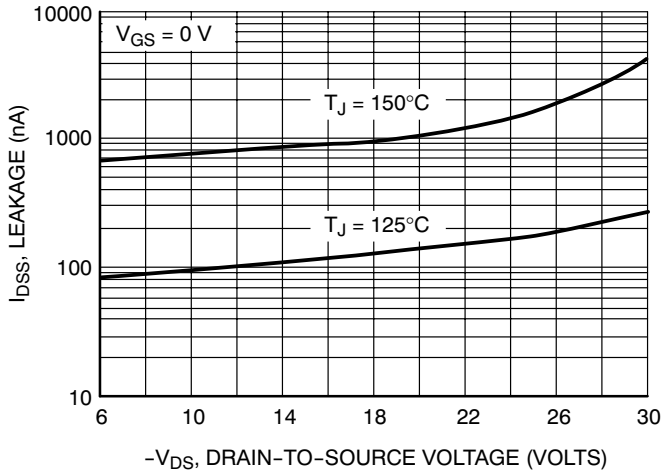
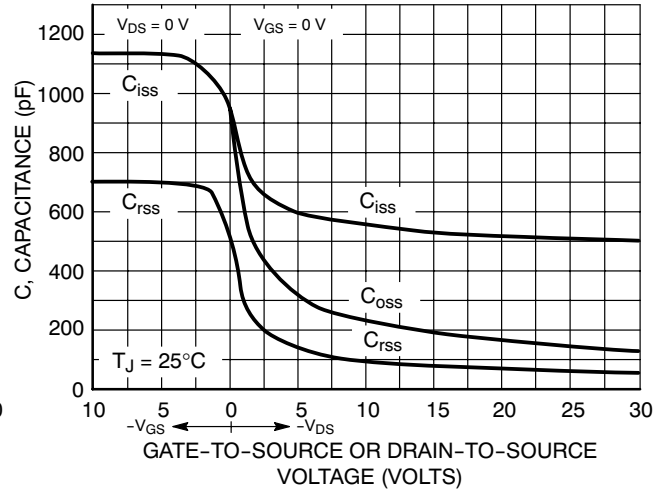


Figure 5. On Resistance Variation with Temperature

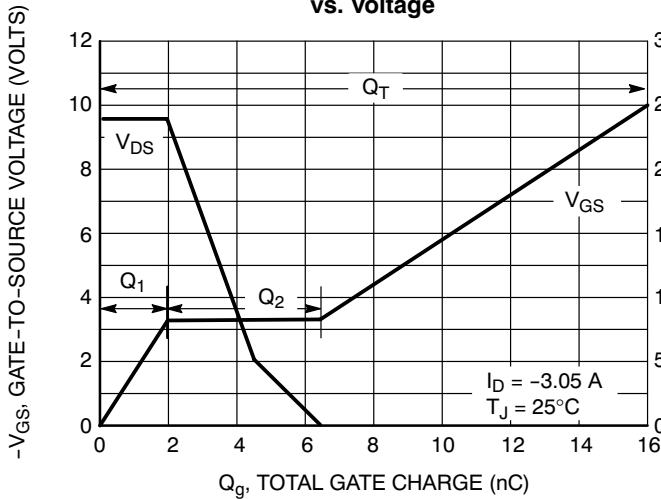
# NTMS3P03R2



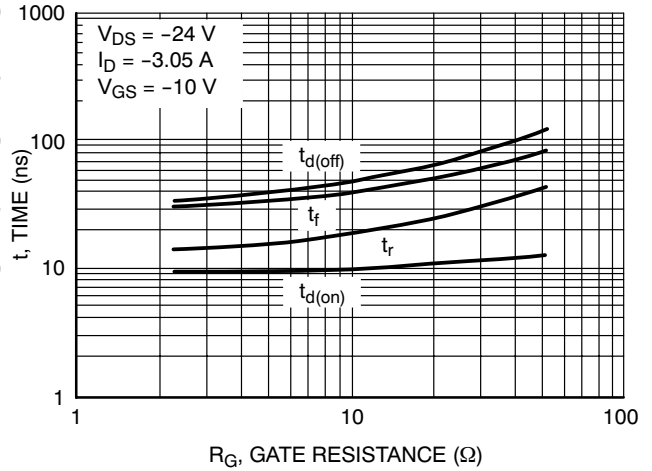
**Figure 6. Drain-to-Source Leakage Current vs. Voltage**



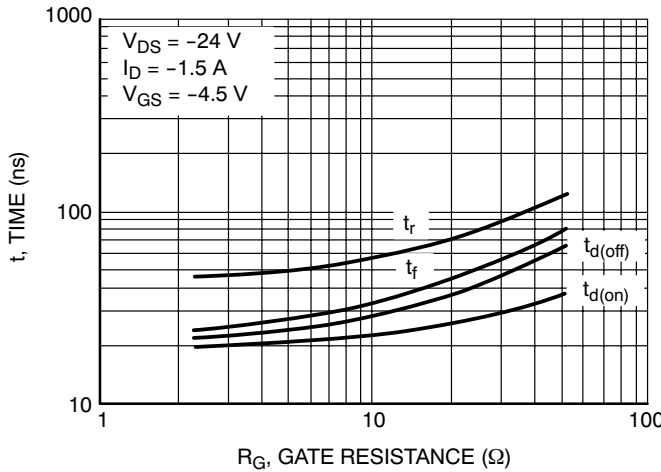
**Figure 7. Capacitance Variation**



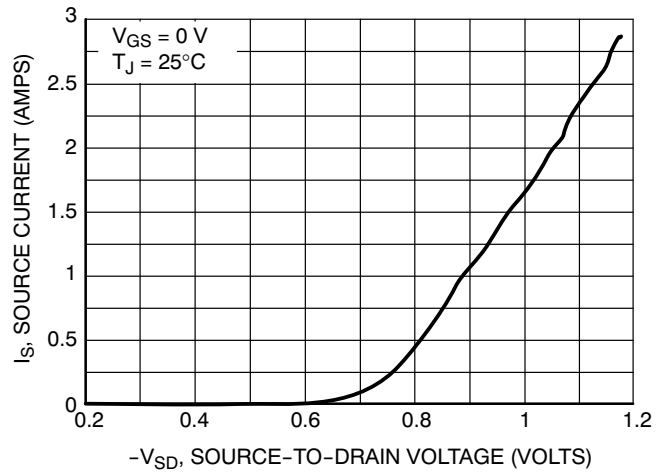
**Figure 8. Gate-to-Source and Drain-to-Source Voltage vs. Total Charge**



**Figure 9. Resistive Switching Time Variation vs. Gate Resistance**

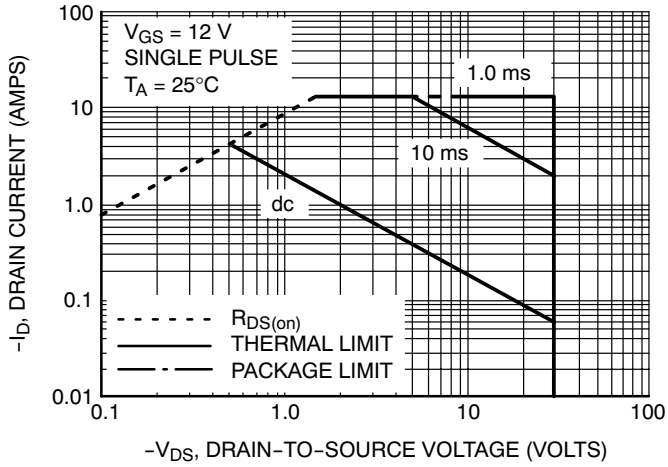


**Figure 10. Resistive Switching Time Variation vs. Gate Resistance**

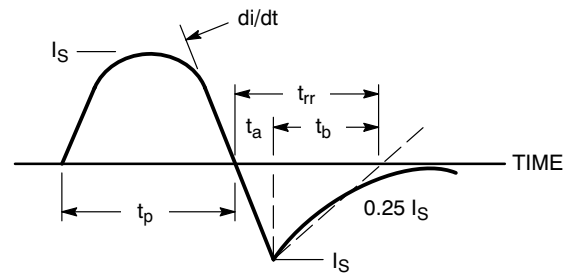


**Figure 11. Diode Forward Voltage vs. Current**

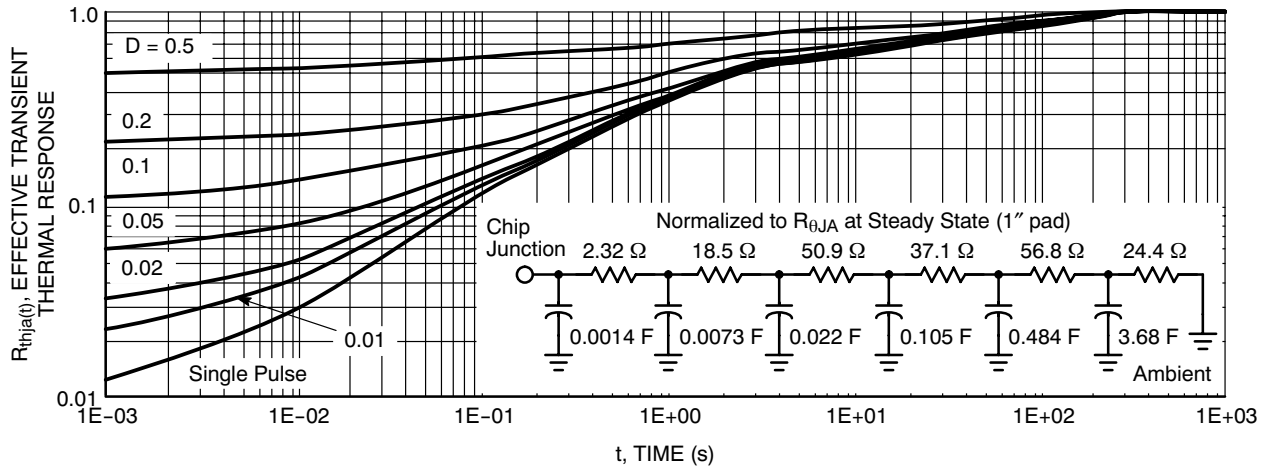
# NTMS3P03R2



**Figure 12. Maximum Rated Forward Biased Safe Operating Area**



**Figure 13. Diode Reverse Recovery Waveform**

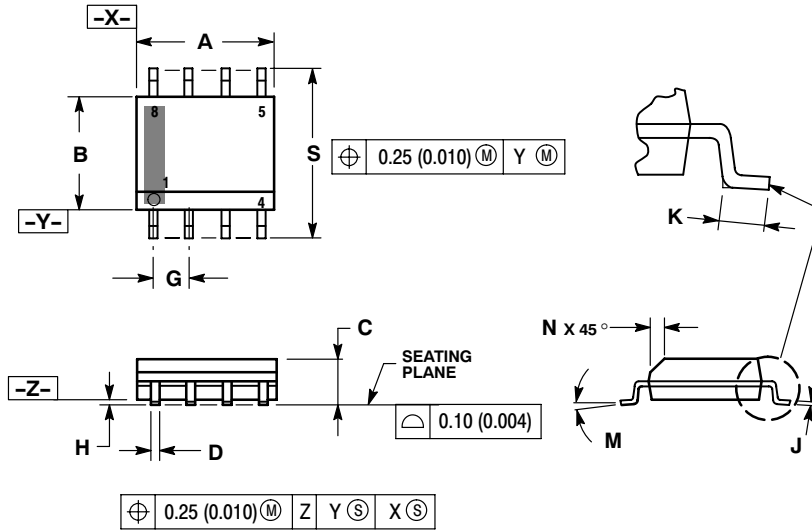


**Figure 14. FET Thermal Response**

# NTMS3P03R2

## PACKAGE DIMENSIONS

SOIC-8 NB  
CASE 751-07  
ISSUE AH



NOTES:

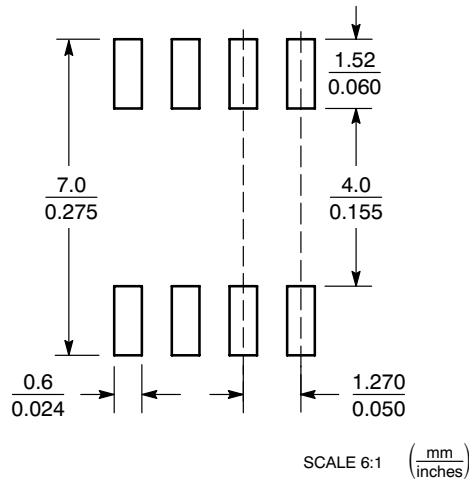
1. DIMENSIONING AND TOLERANCING PER ANSI Y14.5M, 1982.
2. CONTROLLING DIMENSION: MILLIMETER.
3. DIMENSION A AND B DO NOT INCLUDE MOLD PROTRUSION.
4. MAXIMUM MOLD PROTRUSION 0.15 (0.006) PER SIDE.
5. DIMENSION D DOES NOT INCLUDE DAMBAR PROTRUSION. ALLOWABLE DAMBAR PROTRUSION SHALL BE 0.127 (0.005) TOTAL IN EXCESS OF THE D DIMENSION AT MAXIMUM MATERIAL CONDITION.
6. 751-01 THRU 751-06 ARE OBSOLETE. NEW STANDARD IS 751-07.

DIM	MILLIMETERS		INCHES	
	MIN	MAX	MIN	MAX
A	4.80	5.00	0.189	0.197
B	3.80	4.00	0.150	0.157
C	1.35	1.75	0.053	0.069
D	0.33	0.51	0.013	0.020
G	1.27 BSC		0.050 BSC	
H	0.10	0.25	0.004	0.010
J	0.19	0.25	0.007	0.010
K	0.40	1.27	0.016	0.050
M	0°	8°	0°	8°
N	0.25	0.50	0.010	0.020
S	5.80	6.20	0.228	0.244

STYLE 13:

1. N.C.
2. SOURCE
3. SOURCE
4. GATE
5. DRAIN
6. DRAIN
7. DRAIN
8. DRAIN

### SOLDERING FOOTPRINT\*



\*For additional information on our Pb-Free strategy and soldering details, please download the ON Semiconductor Soldering and Mounting Techniques Reference Manual, SOLDERRM/D.

ON Semiconductor and are registered trademarks of Semiconductor Components Industries, LLC (SCILLC). SCILLC reserves the right to make changes without further notice to any products herein. SCILLC makes no warranty, representation or guarantee regarding the suitability of its products for any particular purpose, nor does SCILLC assume any liability arising out of the application or use of any product or circuit, and specifically disclaims any and all liability, including without limitation special, consequential or incidental damages. "Typical" parameters which may be provided in SCILLC data sheets and/or specifications can and do vary in different applications and actual performance may vary over time. All operating parameters, including "Typicals" must be validated for each customer application by customer's technical experts. SCILLC does not convey any license under its patent rights nor the rights of others. SCILLC products are not designed, intended, or authorized for use as components in systems intended for surgical implant into the body, or other applications intended to support or sustain life, or for any other application in which the failure of the SCILLC product could create a situation where personal injury or death may occur. Should Buyer purchase or use SCILLC products for any such unintended or unauthorized application, Buyer shall indemnify and hold SCILLC and its officers, employees, subsidiaries, affiliates, and distributors harmless against all claims, costs, damages, and expenses, and reasonable attorney fees arising out of, directly or indirectly, any claim of personal injury or death associated with such unintended or unauthorized use, even if such claim alleges that SCILLC was negligent regarding the design or manufacture of the part. SCILLC is an Equal Opportunity/Affirmative Action Employer. This literature is subject to all applicable copyright laws and is not for resale in any manner.

### PUBLICATION ORDERING INFORMATION

LITERATURE FULFILLMENT:  
Literature Distribution Center for ON Semiconductor  
P.O. Box 5163, Denver, Colorado 80217 USA  
Phone: 303-675-2175 or 800-344-3860 Toll Free USA/Canada  
Fax: 303-675-2176 or 800-344-3867 Toll Free USA/Canada  
Email: orderlit@onsemi.com

N. American Technical Support: 800-282-9855 Toll Free  
USA/Canada  
Europe, Middle East and Africa Technical Support:  
Phone: 421 33 790 2910  
Japan Customer Focus Center  
Phone: 81-3-5773-3850

ON Semiconductor Website: [www.onsemi.com](http://www.onsemi.com)

Order Literature: <http://www.onsemi.com/orderlit>

For additional information, please contact your local Sales Representative