

MIO-2270

**AMD® G-series SoC GX-210JA/
GX-415GA Pico-ITX SBC, DDR 3/
3L, 18-bit LVDS, VGA or HDMI,
1GbE, Half-size Mini PCIe, 4
USB, 2 COM, SMBus, mSATA,
and MIOe**

Copyright

The documentation and software included with this product are copyrighted 2014 by Advantech Co., Ltd. All rights are reserved. Advantech Co., Ltd. also reserves the right to improve the products described in this manual at any time without notice.

No part of this manual may be reproduced, copied, translated or transmitted in any form or by any means without prior written permission from Advantech Co., Ltd. The information provided in this manual is intended to be accurate and reliable. However, Advantech Co., Ltd. assumes no responsibility for its use, nor for any infringements of the rights of third parties that may result from its use.

Acknowledgements

AMI is a trademark of AMI Software International, Inc.

Intel® is a trademark of Intel® Technologies, Inc.

IBM, PC/AT, PS/2 and VGA are trademarks of International Business Machines Corporation.

Intel and Atom® are trademarks of Intel Corporation.

Microsoft Windows® is a registered trademark of Microsoft Corp.

RTL is a trademark of Realtek Semi-Conductor Co., Ltd.

ESS is a trademark of ESS Technology, Inc.

UMC is a trademark of United Microelectronics Corporation.

SMI is a trademark of Silicon Motion, Inc.

Creative is a trademark of Creative Technology Ltd.

All other product names or trademarks are the property of their respective owners.

Product Warranty (2 years)

Advantech warrants the original purchaser that each of its products will be free from defects in materials and workmanship for two years from the date of purchase.

This warranty does not apply to any products that have been repaired or altered by persons other than repair personnel authorized by Advantech, or that have been subject to misuse, abuse, accident or improper installation. Advantech assumes no liability under the terms of this warranty as a consequence of such events.

Because of Advantech's high quality-control standards and rigorous testing, most of our customers never need to use our repair service. If an Advantech product is defective, it will be repaired or replaced at no charge during the warranty period. For out-of-warranty repairs, customers are billed according to the cost of replacement materials, service time and freight. Please consult your dealer for more details.

If you believe your product to be defective, please follow the steps listed below.

1. Collect all information regarding the problem encountered. (For example, CPU speed, Advantech products used, other hardware and software used, etc.) Note anything abnormal and list any onscreen messages you encounter when the problem occurs.
2. Call your dealer and describe the problem. Please have your manual, product, and any related information readily available.
3. If your product is diagnosed as defective, obtain a return merchandise authorization (RMA) number from your dealer. This allows us to process your return more quickly.
4. Carefully pack the defective product, a completed Repair and Replacement Order Card, and proof of purchase date (such as a photocopy of your sales receipt) in a shippable container. Products returned without a proof of purchase date are not eligible for our warranty service.
5. Write the RMA number clearly on the outside of the package before shipping the product prepaid to your dealer.

Technical Support and Assistance

1. Visit the Advantech website at www.advantech.com/support to obtain the latest information regarding your product.
2. Contact your distributor, sales representative, or Advantech's customer service center for technical support if you require additional assistance. Please have the following information ready before calling:
 - Product name and serial number
 - Description of your peripheral attachments
 - Description of your software (OS, version number, application software, etc.)
 - A complete description of the problem
 - The exact wording of any error messages

Packing List

Before installation, please ensure that the following items have been included in the shipment:

Item

- MIO-2270 SBC
- Startup manual
- Cables

Part No.	Description
1700006291	SATA cable 7P 30 cm w / right angle
1700022444-01	Audio cable 2*5P-2.0 / JACK*2 20 cm
1701200220	COM port cable 2*10P-2.0 / D-SUB 9P(M)*2 22 cm
1700019656	SATA power cable 5P-1.25 / 5P-2.0+SATA 5P 15 cm
1700002172	USB cable 2.0 mm pitch USB-A(F) 17 cm
1700019705	AT power cable 12 cm

- Thermal solution

1960063455T011	Heat sink for MIO-2270DV
1960063062T001	Cooler for MIO-2270QV/QH

- Studs and screws

Part No.	Description
9666226300E	Stud and screw pack
1910002596-01	Stud F = M3*10L M = M3*5L B = 5 H = 19, 4 pcs
1935031500	Screw R/S D = 5.3 H = 2 + M3*15L, 4 pcs
193B0204C0	Screw F/S D = 3.5 H = 0.8 + M2*4L, 2 pcs

Ordering Information

Model No.	Description
MIO-2270DV-S0A1E	AMD® G-series SoC GX-210JA, fanless, LVDS, VGA, GbE, Mini PCIe, 4 USB, 2 COM, SMBus, mSATA, and MIOe
MIO-2270QV-S5A1E	AMD® G-series SoC GX-415GA, cooler, LVDS, VGA, GbE, Mini PCIe, 4 USB, 2 COM, SMBus, mSATA, and MIOe
MIO-2270QH-S5A1E	AMD® G-series SoC GX-415GA, cooler, LVDS, HDMI, GbE, Mini PCIe, 4 USB, 2 COM, SMBus, mSATA, and MIOe

Optional Accessories

Part No.	Description
1960065075N001	Heat spreader (99.5 x 70.5 x 11.2 mm)

Declaration of Conformity

This device complies with the stipulations specified in Part 15 of the FCC regulations. Operation of this device is subject to the following two conditions:

1. The device may not cause harmful interference.
2. The device must accept any interference received, including interference that can cause undesired operation.

FCC Class A

This equipment has been tested and found to comply with the specifications for a Class A digital device, pursuant to Part 15 of the FCC regulations. These standards were established to provide reasonable protection against harmful interference when operating the equipment in a commercial environment. This equipment generates, uses, and can radiate radio frequency energy and, if not installed and used in accordance with the instruction manual, may cause harmful interference to radio communications. Thus, operation of this device in residential areas is likely to cause harmful interference. In such cases, users are required to correct the interference at their personal expense. Users are advised that any equipment changes or modifications not expressly approved by the party responsible for compliance will void the product's compliance with the FCC regulations and, therefore, the user's authority to operate this equipment.

Caution! *New batteries are at risk of exploding if incorrectly installed. Do not attempt to recharge, force open, or heat the battery. Replace the battery only with the same or equivalent type recommended by the manufacturer. Discard used batteries according to the manufacturer's instructions.*



Safety Instructions

1. Please read the following safety instructions carefully.
2. Retain this user manual for future reference.
3. Disconnect the equipment from all electrical outlets before cleaning. Use only a damp cloth to clean the equipment; do not apply liquid or spray detergents.
4. For equipment that requires a power supply, users are advised to position the equipment near an easily accessible power outlet socket.
5. Protect this equipment from humidity.
6. Place this equipment on a reliable surface during installation. Dropping or allowing the equipment to fall may cause damage.
7. The equipment cover openings are necessary for air convection. Protect the equipment from overheating and do not cover the opening.
8. Ensure the power source voltage is correct before connecting the equipment to a power outlet.
9. Position the power cord away from high-traffic areas. Do not place anything over the power cord.
10. All cautions and warnings on the equipment should be noted.
11. If unused for a long time, disconnect the equipment from the power source to avoid damage from transient overvoltages.
12. Never pour liquids into the cover openings. This may cause fire or electrical shock.
13. Never open the equipment. For safety reasons, the equipment should only be opened by qualified service personnel.
14. If any of the following occurs, have the equipment checked by service personnel:
 - The power cord or plug is damaged.
 - Liquid has penetrated into the equipment.
 - The equipment is exposed to moisture.
 - The equipment is malfunctioning, or does not operate according to the user manual.
 - The equipment has been dropped or damaged.
 - The equipment shows obvious signs of breakage.
15. Do not leave this equipment in an environment with a storage temperature of below $-20\text{ }^{\circ}\text{C}$ ($-4\text{ }^{\circ}\text{F}$) or above $60\text{ }^{\circ}\text{C}$ ($140\text{ }^{\circ}\text{F}$). This may damage the equipment. The equipment should be stored in a controlled environment.
16. A risk of explosion exists if the battery is incorrectly replaced. Replace batteries only with the same or equivalent type recommended by the manufacturer. Discard used batteries according to the manufacturer's instructions.

The sound pressure level at the operator's position does not exceed 70 dB (A), as per the IEC 704-1:1982 specifications.

DISCLAIMER: These instructions are provided according to the IEC 704-1 standard. Advantech disclaims all responsibility for the accuracy of the statements contained herein.

Safety Precautions - Static Electricity

Adhere to the following simple precautions to protect yourself from harm and the products from damage:

- To avoid electrical shock, always disconnect the power from the PC chassis before handling the equipment. Do not touch components on the CPU card or other cards when the PC is powered on.
- Disconnect the power supply before implementing configuration changes. A sudden rush of power after connecting a jumper or installing a card may damage sensitive electronic components.

Contents

Chapter 1 General Introduction1

1.1	Introduction	2
1.2	Specifications	2
1.2.1	General Specifications	2
1.2.2	Functional Specifications	3
1.2.3	Mechanical Specifications	4
1.2.4	Electrical Specifications	5
1.2.5	Environmental Specifications	5
1.3	Block Diagram	6
	Figure 1.1 Block diagram	6

Chapter 2 H/W Installation.....7

2.1	Jumpers	8
2.1.1	Jumper Description	8
2.1.2	Jumper List	8
	Table 2.1: Jumper List	8
2.1.3	Jumper Settings	8
	Table 2.2: J1: LCD Power / Auto Power On	8
2.2	Connectors	10
2.2.1	Connector List	10
2.2.2	Connector Settings	10
2.3	Mechanical	13
2.3.1	Jumper and Connector Locations	13
	Figure 2.1 Jumper and connector layout (top side)	13
	Figure 2.2 Jumper and connector layout (bottom side)	13
2.3.2	Board Dimensions	14
	Figure 2.3 Board dimensions and layout (top side)	14
	Figure 2.4 Board dimensions and layout (bottom side)	14
	Figure 2.5 Board dimensions and layout (side view)	15
	Figure 2.6 Board dimensions and layout (coastline with optional DC jack)	15
	Figure 2.7 Board dimensions and layout (coastline with power connector and heat sink)	16
	Figure 2.8 Board dimensions and layout (coastline with power connector and optional heat spreader)	16
	Figure 2.9 Board dimensions and layout (coastline with cooler)	16
	Figure 2.10 MIO module height constraints	17
	Figure 2.11 Heat spreader assembly	18

Chapter 3 BIOS Settings.....19

3.1	BIOS Setup	20
3.2	Entering the Setup Menu	21
3.2.1	Main Setup Menu	21
3.2.2	Advanced BIOS Features	22
3.2.3	Chipset Configuration	33
3.2.4	Boot Configuration	38
3.2.5	Security Configuration	39
3.2.6	Save and Exit	40

Chapter	4	S/W Introduction and Installation....	41
4.1		S/W Introduction	42
4.2		Driver Installation	42
	4.2.1	Windows 7 Professional	42
	4.2.2	Alternate OS	42
4.3		Value-Added Software Services	42
	4.3.1	SUSI Introduction.....	42
	4.3.2	Software APIs	43
	4.3.3	SUSI Installation	44
	4.3.4	SUSI Sample Programs.....	45
Appendix A		Pin Assignments	53
A.1		Jumper Settings	54
		Table A.1: Jumper List.....	54
A.2		Connectors.....	54
		Table A.2: Connectors	54
		Table A.3: J1: LCD Power / Auto Power On.....	54
Appendix B		WDT and GPIO	75
B.1		Watchdog Timer Sample Code.....	76
B.2		GPIO Sample Code	77
Appendix C		System Assignments.....	79
C.1		System I/O Ports.....	80
		Table C.1: System I/O Ports	80
C.2		First MB Memory Map.....	80
		Table C.2: First MB Memory Map	80
C.3		Interrupt Assignments	81
		Table C.3: Interrupt Assignments	81

Chapter 1

General Introduction

This chapter provides general information about MIO-2270.

- Introduction
- Product Features
- Specifications

1.1 Introduction

MIO-2270 is a MI/O-ultra single-board computer (SBC) with AMD® embedded G-series SoC dual-core GX-210JA 1.0 GHz and quad-core GX-415GA 1.5 GHz processors. MIO-2270 supports up to 8 GB of DDR3 or DDR3L memory, features two USB 2.0 and two USB 3.0-compatible ports, one GbE (up to 1000 Mbps) interface, LVDS and VGA or HDMI support, high definition (HD) audio, and one half-size mini-PCIe and MIOe expansion slot. In addition, MIO-2270 accommodates one SATA drive, two COM ports, one SMBus, one GPIO and one half-size mSATA slot. Advantech's innovative multiple I/O (MI/O) extension SBC is equipped with flexible MI/O to assist integrators with developing optimized solutions.

1.2 Specifications

1.2.1 General Specifications

- **CPU:** AMD® G-series SoC dual-core 1.0 GHz (GX-210JA) / quad-core 1.5 GHz (GX-415GA)
- **System Chipset:** AMD® G-series SoC GX-210JA/GX-415GA
- **BIOS:** AMI EFI 32 Mbit Flash BIOS
- **System Memory:** DDR3 / DDR3L 1066 MHz for GX-210JA / 1600 MHz for GX-415GA
- **Watchdog Timer:** Single-chip watchdog 255-level interval timer, setup using software
- **Expansion Interface:**
 - 1 x half-size mini PCIe slot
 - 1 x MIOe connector: supports 2 x USB 2.0, 2 x PCIe x1, LPC, HD audio line-out, SMBus, DP (or HDMI, supported upon request), 5 Vsb / 12 Vsb power
- **Battery:** Lithium 3 V / 210 mAH

I/O

- **Internal I/O Interface:** 2 x USB2.0, 1 x RS-232, 1 x RS-232/422/485, 1 x HD audio (line-in, line-out), GPIO, SMBus
- **Rear I/O Ports:** 1 x RJ45 Ethernet, 1 x VGA or HDMI, 2 x USB, 1 x power connector (or DC jack, supported upon request):

Ethernet

- **Controller:** Realtek RTL8111E (GbE1)
- **Speed:** 10 / 100 / 1000 Mbps
- **Connector:** 1 x RJ45
- **Standard:** Compliant with IEEE 802.3, IEEE 802.3u, IEEE 802.3x, IEEE 802.ab
- Supports wake-on-LAN

Display

- **Controller:** GX-415GA / GX-210JA, Directx* 11 and OpenGL 4.2 support
- **Resolution:**
 - VGA: 2048 x 1536 60 Hz at 267 MHz Max
 - LVDS: 18-bit LVDS1, up to 1600 x 900
 - HDMI: Up to 1920 x 1200 (1080p)

1.2.2 Functional Specifications

Processor

Processor	<ul style="list-style-type: none"> ■ AMD® G-series SoC GX-210JA / GX-415GA ■ Frequency <ul style="list-style-type: none"> – GX-210JA 1.0 GHz – GX-415GA 1.5 GHz ■ Manufacturing Technology: 28 nm ■ L2 Cache: <ul style="list-style-type: none"> – 1 MB for GX-210JA – 2 MB for GX-415GA
Memory	<ul style="list-style-type: none"> ■ Supports DDR3 / DDR3L 1066 MHz for GX-210JA, 1600 MHz for GX-415GA, up to 8 GB ■ SODIMM Socket: 204-pin SODIMM socket type *1
Graphic Engine	<ul style="list-style-type: none"> ■ DirectX* 11-compliant and supports Pixel Shader 2.0 and OGL 4.2 ■ 2D Acceleration <ul style="list-style-type: none"> – Highly optimized 128-bit engine ■ 3D Acceleration <ul style="list-style-type: none"> – Full DirectX 11.1 support, including full-speed 32-bit floating point-per-component operations – Shader Model 5 – OpenCL 1.2 – OpenGL 4.1/ 4.1+ ■ Motion Video Acceleration <ul style="list-style-type: none"> – Dedicated hardware (UVD 4.2) for H.264, MPEG2/4, VC1, MVC decode, dedicated hardware encode (VCE 2.0) for H.264 – HD HQV and SD HQV support – Super SD to HD resolution up-conversion
Display	<ul style="list-style-type: none"> ■ VGA: 2048 x 1536 @ 60 Hz ■ LVDS1: 18-bit, up to 1600 x 900 @ 60 Hz ■ HDMI: Up to 1920 x 1200 (1080p) ■ Dual independent display: VGA + LVDS or HDMI + LVDS

Chipset

Control Hub	<ul style="list-style-type: none"> ■ AMD® G-series SoC GX-210JA / GX-415GA
Audio	<ul style="list-style-type: none"> ■ ALC888S HD audio codec ■ Supports two pulse-code modulation (PCM) audio output channels ■ Connectors: line-out, line-in
PCI-Express Interface	<ul style="list-style-type: none"> ■ 4 PCI-Express x1 lanes ■ Lane 1: Realtek RTL8111E GbE controller ■ Lane 2: Half-size Mini PCIe connector ■ Lanes 3 & 4: MIOe connector
SATA Interface	<ul style="list-style-type: none"> ■ 1 x mSATA by Mini-Pcie socket (integrates USB signals, and supports either mSATA or USB interface modules) ■ 1 x SATAIII (600 MB/s maximum data transfer rate)

USB Interface	<ul style="list-style-type: none"> ■ 2 x internal USB 2.0 ports ■ 2 x rear I/O USB 3.0 ports at coastline ■ Transmission speeds of up to 5 Gbps (USB 3.0) / 480 Mbps (USB 2.0)
Power Management	<ul style="list-style-type: none"> ■ Advanced Configuration and Power Interface (ACPI) 3.0 ■ Supports S0, S3, S4, S5 ■ Supports wake-on-LAN
BIOS	AMI EFI 32-Mbit Flash BIOS via SPI
Others	
Ethernet	<ul style="list-style-type: none"> ■ Controller: Realtek RTL8111E (GbE1) ■ Compliant with IEEE 802.3, IEEE 802.3u, IEEE 802.3x, and IEEE 802.ab ■ Supports 10 / 100 / 1000 Mbps ■ Connectors: RJ45 ■ LAN 1 LED <ul style="list-style-type: none"> – Link: Green (100 Mbps) / Orange (1000 Mbps) – Active: Green (flash) ■ Supports wake-on-LAN
Serial ports	<ul style="list-style-type: none"> ■ Controller: SMSC SCH 3114 ■ 1 x RS-232, 1 x RS-232/422/485 serial ports with ESD protection: air gap ± 15 kV, contact ± 8 kV
GPIO	<ul style="list-style-type: none"> ■ Controller: SMSC SCH 3114 ■ 8-bit (programming) through Super I/O, pin header ■ 5 V tolerance
SMBus	Default is SMBus

1.2.3 Mechanical Specifications

1.2.3.1 Dimensions (mm)

L100 mm x W72 mm (3.9" x 2.8")

1.2.3.2 Height of Component Side (mm)

15.7 mm (heat sink)

1.2.3.3 Height of Solder Side (mm)

16.4 mm (rear I/O USB)

1.2.3.4 Weight (g)

420 g (0.93 lb, total package weight)

1.2.4 Electrical Specifications

Power Supply Type: Single 12 V DC power input (supports DC power hot plug)

1.2.4.1 Power Supply Voltage

- Single 12 V input $\pm 10\%$
- Total peripheral power supply output: 5 V @ 3 A for CPU board and MIOe module combined, 12 V @ 2 A for MIOe module

1.2.4.2 Power Consumption

- **Typical in Windows 7 Idle Mode:**
GX-415GA: 1.05 A @ 12 V (12.6 W)
GX-210JA: 0.49 A @ 12 V (5.93 W)
- **Maximum in Windows 7 HCT12 (10 minutes):**
GX-415GA: 1.26 A @ 12 V (15.12 W)
GX-210JA: 0.85 A @ 12 V (10.2 W)

1.2.4.3 RTC Battery

- **Typical Voltage:** 3.0 V
- **Standard Discharge Capacity:** 210 mAh

1.2.5 Environmental Specifications

1.2.5.1 Operating Humidity

40 °C @ 95% RH non-condensing

1.2.5.2 Operating Temperature

0 ~ 60 °C (32 ~ 140 °F)

1.2.5.3 Storage Humidity

60 °C @ 95% RH non-condensing

1.2.5.4 Storage Temperature

-40 ~ 85 °C (-40 ~ 185 °F)

1.3 Block Diagram

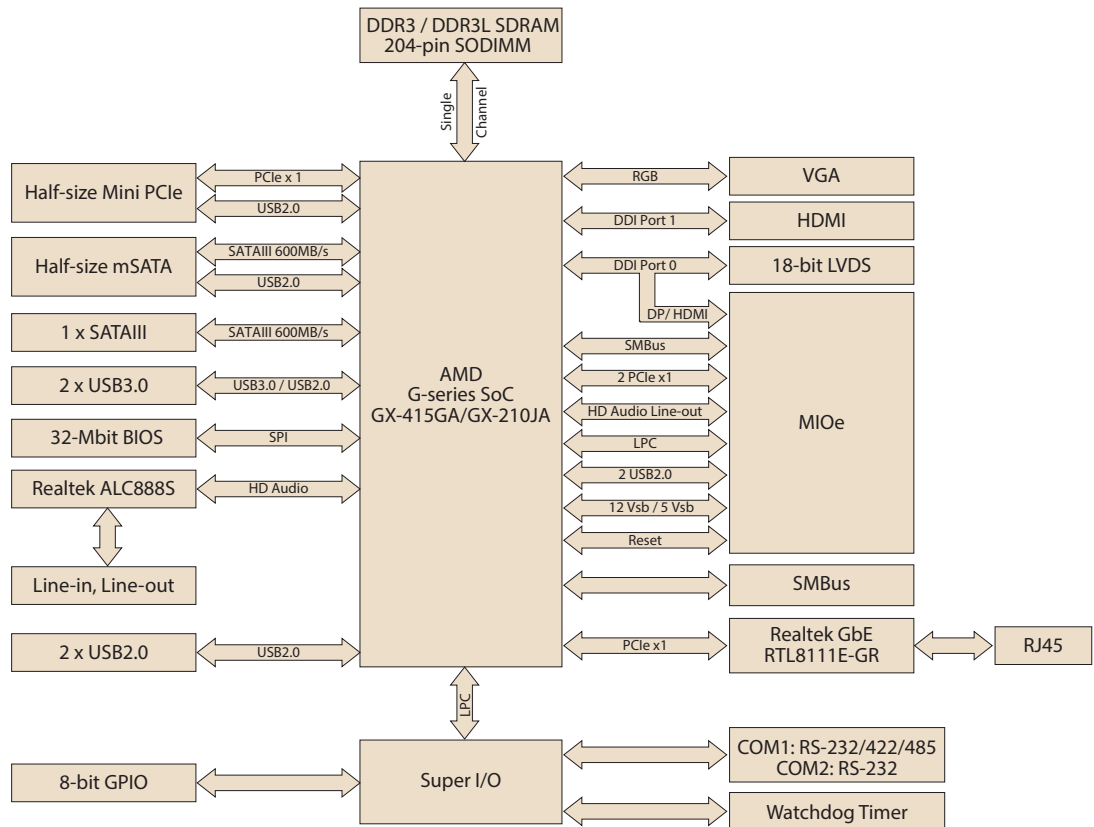

Figure 1.1 Block diagram

Chapter 2

H/W Installation

This chapter provides information on the hardware setup procedures, including instructions for connecting jumpers, peripherals, switches, and indicators, as well as mechanical drawings. Please read all safety precautions before beginning installation.

2.1 Jumpers

2.1.1 Jumper Description

Cards can be configured by setting jumpers. A jumper is a metal bridge used to close an electric circuit. It consists of two metal pins and a small metal clip (often protected by a plastic cover) that slides over the pins to connect them. To close a jumper, connect the pins with the clip. To open a jumper, simply remove the clip. Some jumpers have three pins, labeled 1, 2 and 3. In this case, connect either pins 1 and 2, or 2 and 3.

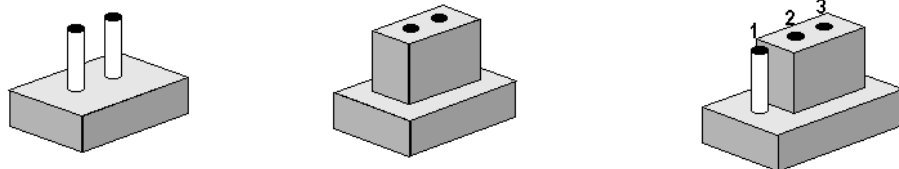

The jumper settings are schematically depicted in this manual as follows:



A pair of needle-nose pliers may be required to adjust the jumpers. For advice regarding the optimum hardware configuration for your needs, contact your local distributor or sales representative before making any changes.

Generally, a standard cable can support most connections.

Warning! To avoid damaging the computer, always turn the power supply off before setting jumpers.



2.1.2 Jumper List

Table 2.1: Jumper List

J1	LCD power / Auto power on
SW1	DDR3 / DDR3L power select
SW2	LAN Enable/ Disable

2.1.3 Jumper Settings

Table 2.2: J1: LCD Power / Auto Power On

Part No.	1653003260
Footprint	HD_3x2P_79
Description	Pin header 3*2P 180D(M) 2.0 mm SMD square pin
Setting	Function
(1-2)	+5 V
(3-4) (default)	+3.3 V
(5-6) (default)	Auto power on

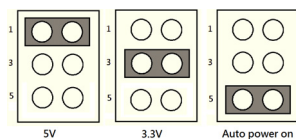

SW1	DDR3 / DDR3L power select
Part No.	1600000071
Footprint	SW_3P_CJS-1201TA1
Description	DIP SW CJS-1201TA1 SMD 3P SPDT P = 6.0 mm W = 2.5 mm
Setting	Function
(1-2)	DDR3L
(2-3)*	DDR3

*default

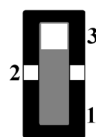
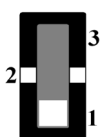

SW2	LAN Enable / Disable
Part No.	1600000071
Footprint	SW_3P_CJS-1201TA1
Description	DIP SW CJS-1201TA1 SMD 3P SPDT P = 6.0 mm W = 2.5 mm
Setting	Function
(1-2)*	LAN Enable
(2-3)	LAN Disable

*default

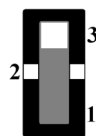
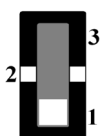

2.2 Connectors

2.2.1 Connector List

CN1	12 V Power input
CN2	DDR3 SODIMM
CN3	18-bit LVDS panel
CN5	HD audio
CN6	Inverter power / Internal SATA power
CN7	GPIO
CN8	DC jack (upon request)
CN10	mSATA
CN12	COM1 / COM2
CN14	Front panel
CN15	VGA
CN16	MIOe
CN17	Gigabit Ethernet
CN18	CPU fan
CN20	HDMI
CN21	SATA
CN22	SMBus
CN24	Internal USB
CN25	External USB
CN31	Mini PCIe
BH1	Battery

2.2.2 Connector Settings

2.2.2.1 12 V Power Input Connector (CN1)

The main power connector supports single 12 V input, with optional DC Jack (CN8, co-layout with 2-pin power connector).

2.2.2.2 DDRIII SODIMM Socket (CN2)

One 204-pin/H 9.2 mm DDRIII DIMM socket supports DDR3 / DDR3L 1066 MHz for GX-210JA, 1600 MHz for GX-415GA, up to 8 GB.

2.2.2.3 Display Interface Connections (CN3, CN15, and CN20)

The MIO-2270 display interface supports either VGA or HDMI on rear I/O and is capable of driving a wide range of flat panel displays, including passive and active LCD displays. The board features three display connector types; among which, one rear I/O can accommodate either standard CRT VGA monitors or an HDMI display and one supports LVDS-type LCD panels.

LVDS LCD panel connector (CN3)

The board supports single-channel 18-bit LVDS LCD panel displays via 14*1-pin wafer bo. Resolution: up to 1600 x 900.

CRT display connector (CN15)

The CRT display 15-pin connector is a rear I/O connector as coastline used for conventional CRT displays. Resolution: up to 2048 x 1536.

HDMI display connector (CN20)

MIO-2270 also supports HDMI display output, satisfying the HDMI 1.4a specifications. Resolution: up to 1920 x 1200.

2.2.2.4 High-Definition Audio Interface (CN5)

MIO-2270 features one 5 x 2-pin box header for audio devices. The header supports HD audio stereo via an audio module customized with onboard.

2.2.2.5 Inverter Power / Internal SATA Power Connector (CN6)

The LCD inverter is connected to CN6 via a 5-pin connector to provide +5 V / +12 V power to the LCD display; 5 V power can be provided to a 2.5" SATA HDD via CN6.

The SATA power current is only sufficient for 2.5" HDD, and the LVDS inverter current is 5 V @ less than 1 A, 12 V @ 500 mA.

2.2.2.6 General Purpose Input Output (GPIO) (CN7)

The board supports 8-bit GPIO (5 V tolerance) via a GPIO pin header. The eight digital inputs and outputs can be programmed to read or control devices, with each input or output clearly defined.

2.2.2.7 mSATA Connector (CN10)

MIO-2270 provides a half-size mini PCIe socket that integrates USB and SATAII signals and supports either mSATA or USB interface modules.

2.2.2.8 COM Port Connectors (CN12)

MIO-2270 features one RS-232 and one RS-232 / 422 / 485 serial ports in a 10 x 2-pin header. This provides connections for serial devices or a communication network. The pin assignments for the COM port connector are presented as Appendix A.

2.2.2.9 Front Panel Connector (CN14)

MIO-2270 comprises an integrated front panel 6-pin connector with the following features:

Power button

Supports on/off operation in ATX mode.

Reset

The recommended reset switch for installation is an open single pole switch. Momentarily pressing the switch initiates a system reset.

Power LED

The power LED indicator activates when the power is on.

HDD LED

The HDD LED indicator for hard disk access is an active low signal.

2.2.2.10 MIOe Connector (CN16)

The MIO-2270 supports MIOe connectors, offering flexible I/O expansion.

Interface

2 x USB 2.0, 2 x PCIe x1, LPC, HD audio line-out, SMBus, DP (or HDMI, supported upon request), 5 Vsb / 12 Vsb power.

Total peripheral power supply output

5 V @ 3 A for the CPU board and MI/O extension module combined, 12 V @ 2 A for the MI/O extension module.

2.2.2.11 Gigabit Ethernet Connector (CN17)

MIO-2270 uses a Realtek® RTL8111E Ethernet chip (10 / 100 / 1000 Mbps) linked to a dedicated PCIe x1 lane via RJ-45 connector.

2.2.2.12 CPU Fan Connector (CN18)

The MIO-2270 integrated with a quad-core processor GX-415GA SKU is equipped with a cooler, that is a 12 V DC fan, as a thermal solution

2.2.2.13 SATA Connector (CN21)

MIO-2270 features one high-performance serial ATA interface. Data transfer rates of up to 600 MB/s enable extremely fast data and file transfers, as well as independent DMA operation on two ports.

2.2.2.14 SMBus Connector (CN22)

MIO-2270 features a SMBus connector to connect with SMBus protocol embedded devices.

2.2.2.15 USB Connectors (CN24 and CN25)

The board provides four USB (Universal Serial Bus) ports, two are rear I/O at coast-line (CN25), and the other two are internal USB ports (CN24). This offers complete plug-and-play functionality, and hot attach/detach for up to 127 external devices. The rear I/O external USB ports comply with USB specifications, Revision. 3.0, and support up to 5 Gbps. The internal USB interfaces comply with USB specifications, Revision 2.0, and features a 480-Mbps transfer rate and fuse protection.

Note! *Please disable USB3.0 controllers from the BIOS setup manual before OS installation. The rear I/O USB3.0 ports are only operational after the OS and USB 3.0 driver are installed.*



2.2.2.16 Mini PCIe Connector (CN31)

MIO-2270 supports a half-size mini PCIe slot. The PCI Express Mini Card (also known as Mini PCI Express, Mini PCIe, and Mini PCI-E) is a replacement for the Mini PCI form factor based on PCI Express, and was developed by PCI-SIG. The host device supports both PCI Express and USB 2.0 connectivity.

Advantech also provides SMBus API, which allows developers to interface with embedded system environments and transfer serial messages using SMBus protocols, facilitating multiple simultaneous device control.

2.2.2.17 Battery Connector (BH1)

MIO-2270 supports a 3 V / 210 mA/HR CR2032 lithium battery with wire via a battery connector (BH1).

Note! *To clear the CMOS, please follow the steps below.*



1. Power off the system
2. Unplug the CR2032 battery cable on BH1
3. Wait 15 seconds or for short BH1 Pins 1 and 2
4. Connect the battery cable on BH1
5. Power on the system

2.3 Mechanical

2.3.1 Jumper and Connector Locations

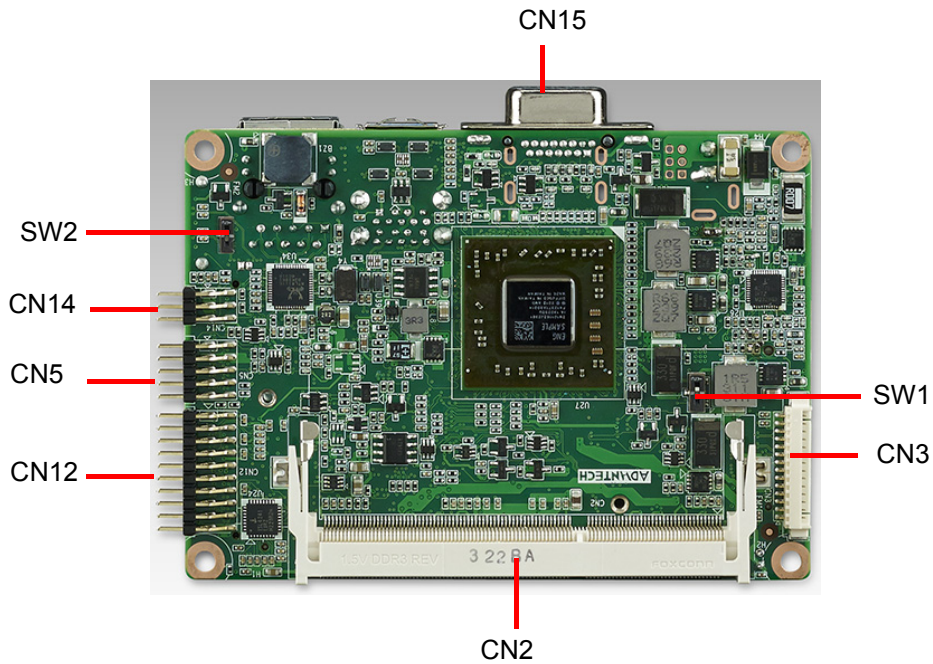

Figure 2.1 Jumper and connector layout (top side)

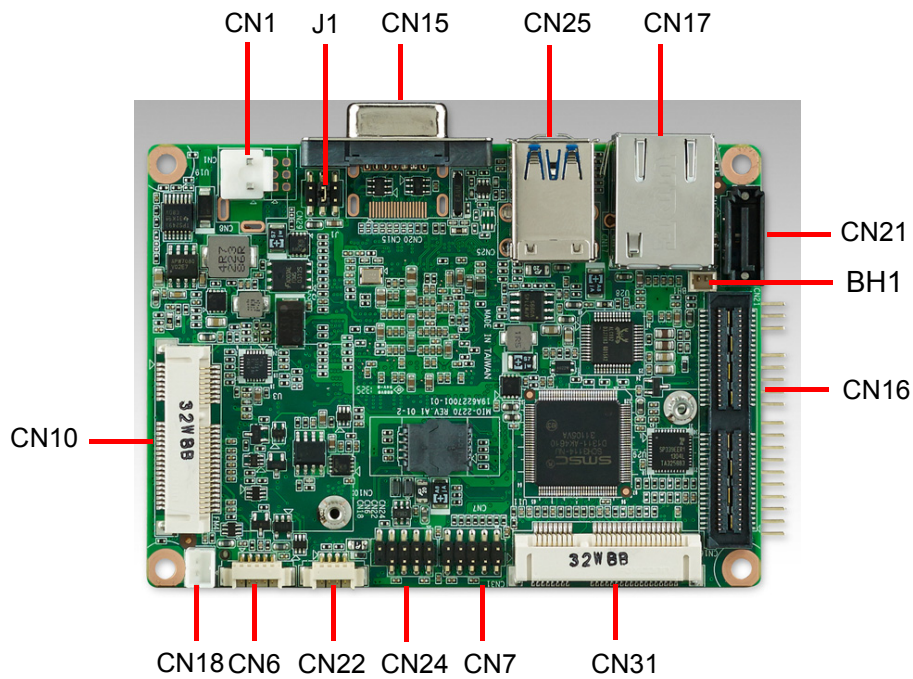
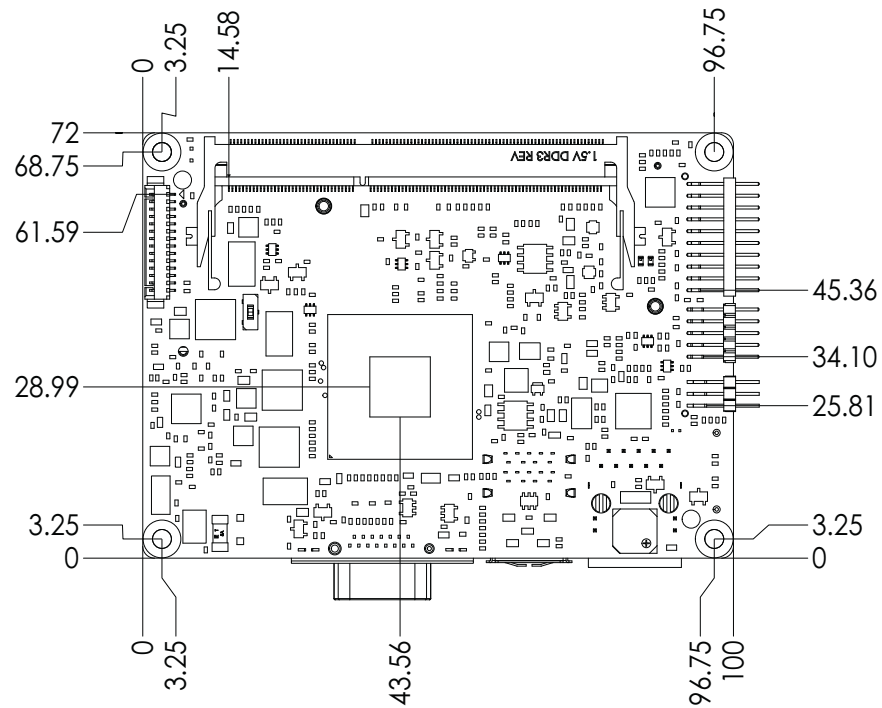

Figure 2.2 Jumper and connector layout (bottom side)

2.3.2 Board Dimensions

2.3.2.1 CPU Board Drawings



Unit: mm

Figure 2.3 Board dimensions and layout (top side)

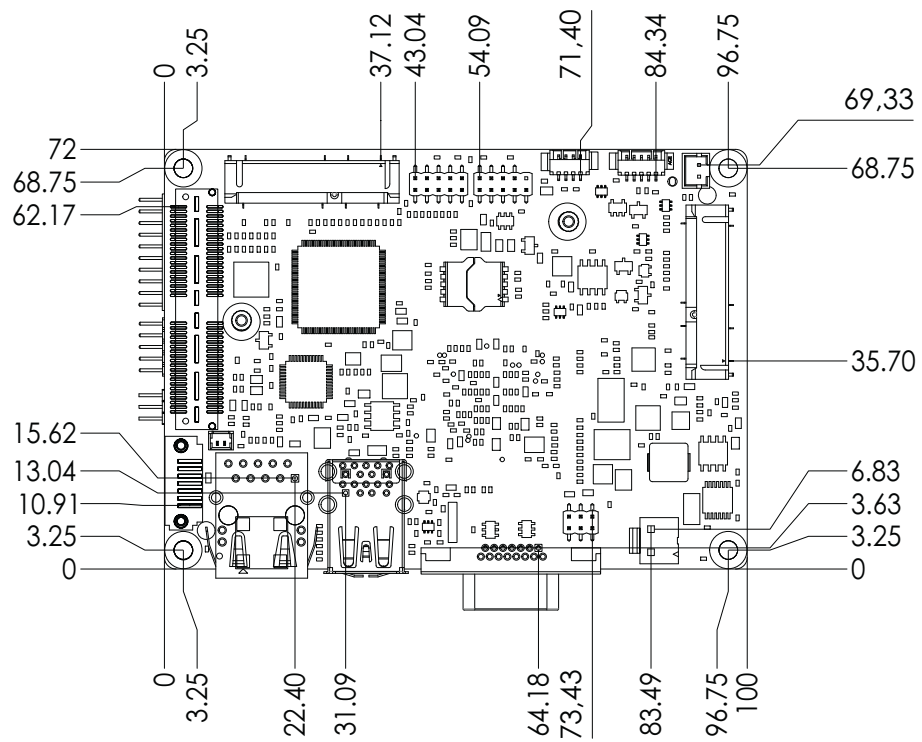

Unit: mm

Figure 2.4 Board dimensions and layout (bottom side)

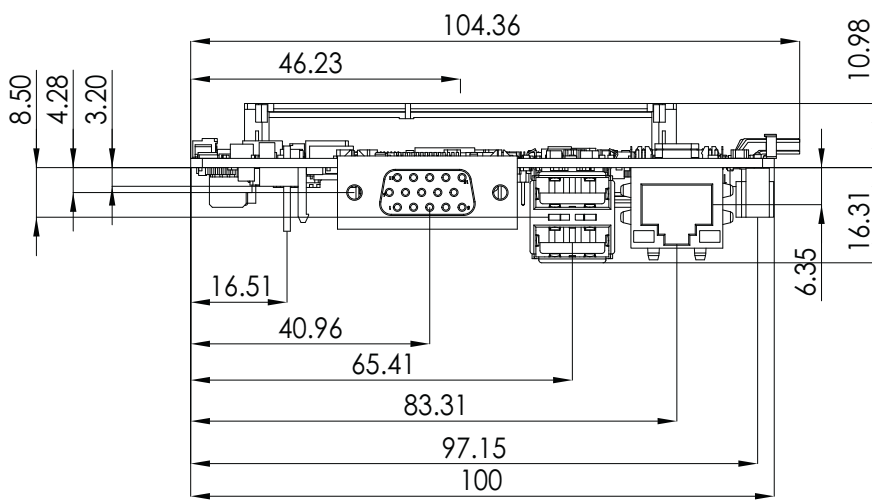

Unit: mm

Figure 2.5 Board dimensions and layout (side view)

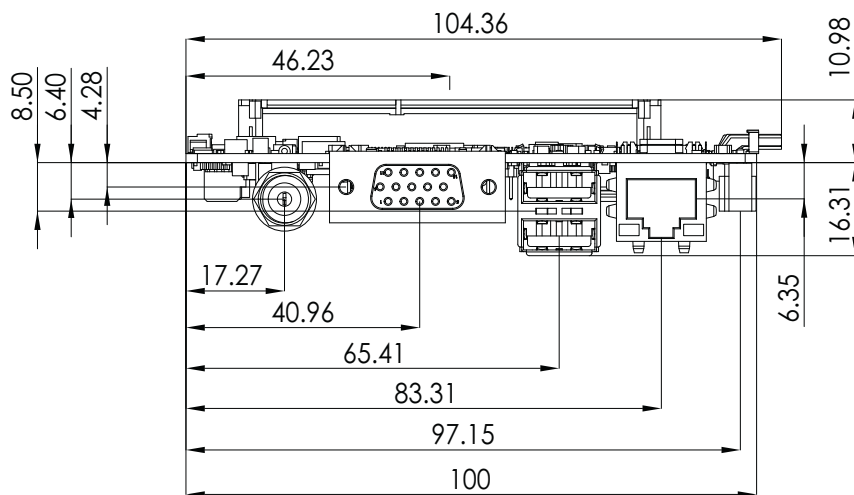

Unit: mm

Figure 2.6 Board dimensions and layout (coastline with optional DC jack)

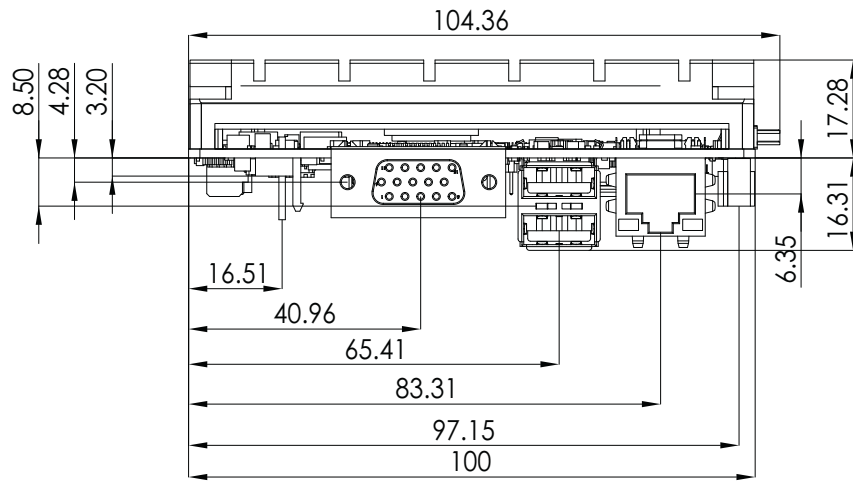

Unit: mm

Figure 2.7 Board dimensions and layout (coastline with power connector and heat sink)

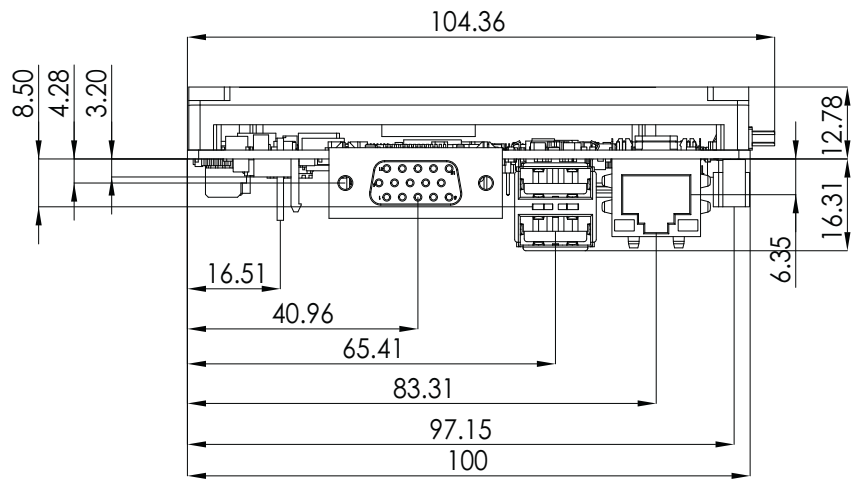

Unit: mm

Figure 2.8 Board dimensions and layout (coastline with power connector and optional heat spreader)

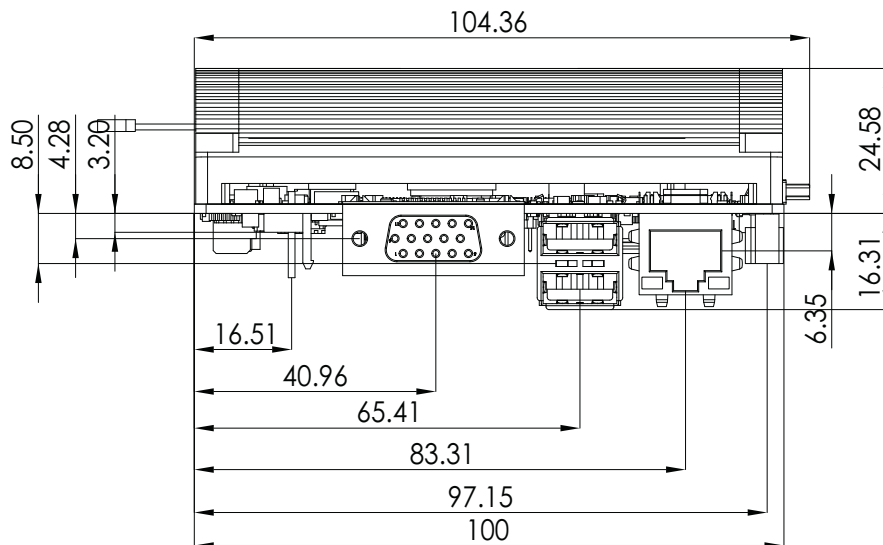

Unit: mm

Figure 2.9 Board dimensions and layout (coastline with cooler)

2.3.2.2 MI/O Module Height Constraint

To avoid mechanical conflicts between the MI/O and ultra CPU board, we recommend referencing the following drawing of the MI/O module height constraints.

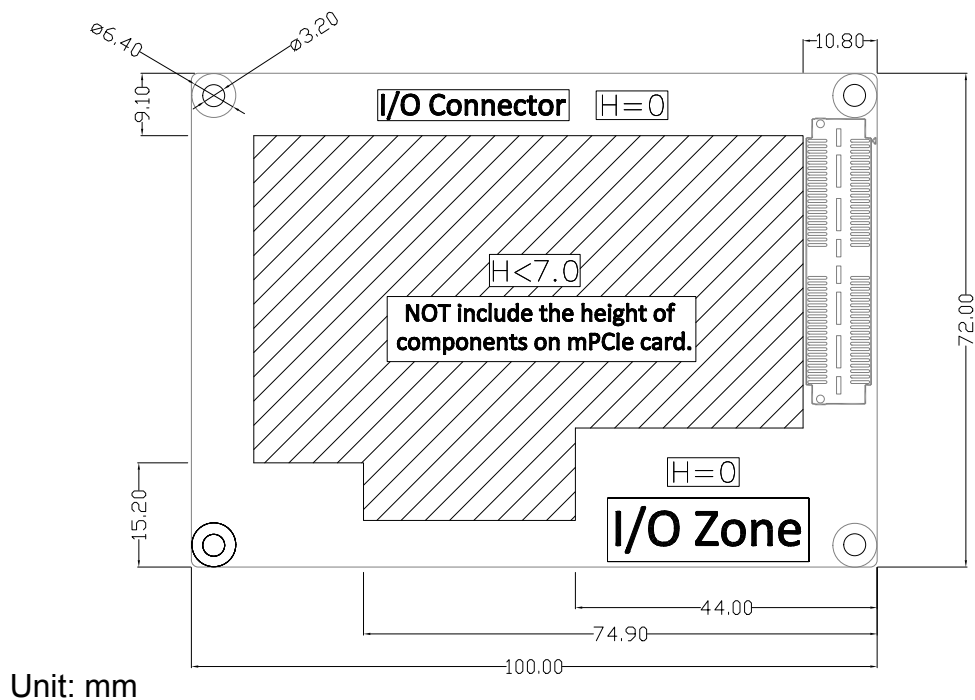

Figure 2.10 MI/O module height constraints

- Note!**
1. The maximum height of the components on the MI/O module base of the MIOe connector is 16 mm (a height of 19 mm is also available upon request).
 2. The height of the MIO-2270 power connector (including the cable) should be considered when assembling the system or stacking the MI/O module.

2.3.2.3 Another Thermal Solution - Heat Spreader

MIO-2270 can accommodate an optional heat spreader for a more comprehensive compact system. Conducting heat to the chassis using a heat spreader is extremely beneficial when systems are extra compact or have limited space for heat convection. Guidelines for heat spreaders are provided below:

1. For optimal heat conduction, minimize the gap between the chassis and heat spreader; the smaller the gap, the better.
2. The default heat spreader height is 11.2 mm (Advantech P/N: 1960065075N001). However, if a different height is required to better fit the chassis, Advantech can customize the heat spreader according to your needs. Please contact our sales center for further information.
3. The heat spreader kit contains thermal grease and screws. If the chassis is positioned near the heat spreader, thermal grease can be applied to enhance conduction. Alternatively, if the chassis is positioned far from the heat spreader, a thermal pad should be employed. A gap of less than 3 mm is recommended for superior heat conduction.

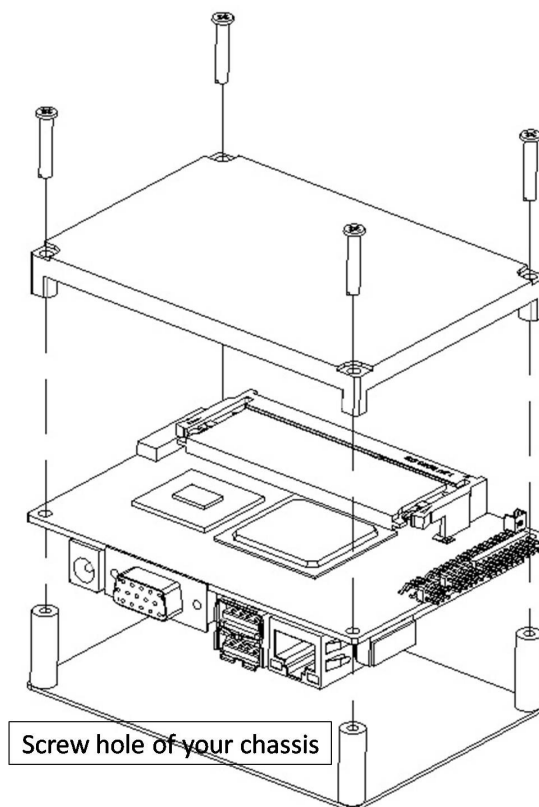

Figure 2.11 Heat spreader assembly

Chapter 3

BIOS Settings

3.1 BIOS Setup

AMIBIOS has been integrated into numerous motherboards over the last decade. With the AMIBIOS Setup program, users can modify the BIOS settings and control various system features. This chapter describes the basic navigation of the MIO-2270 BIOS Setup Utility menu.

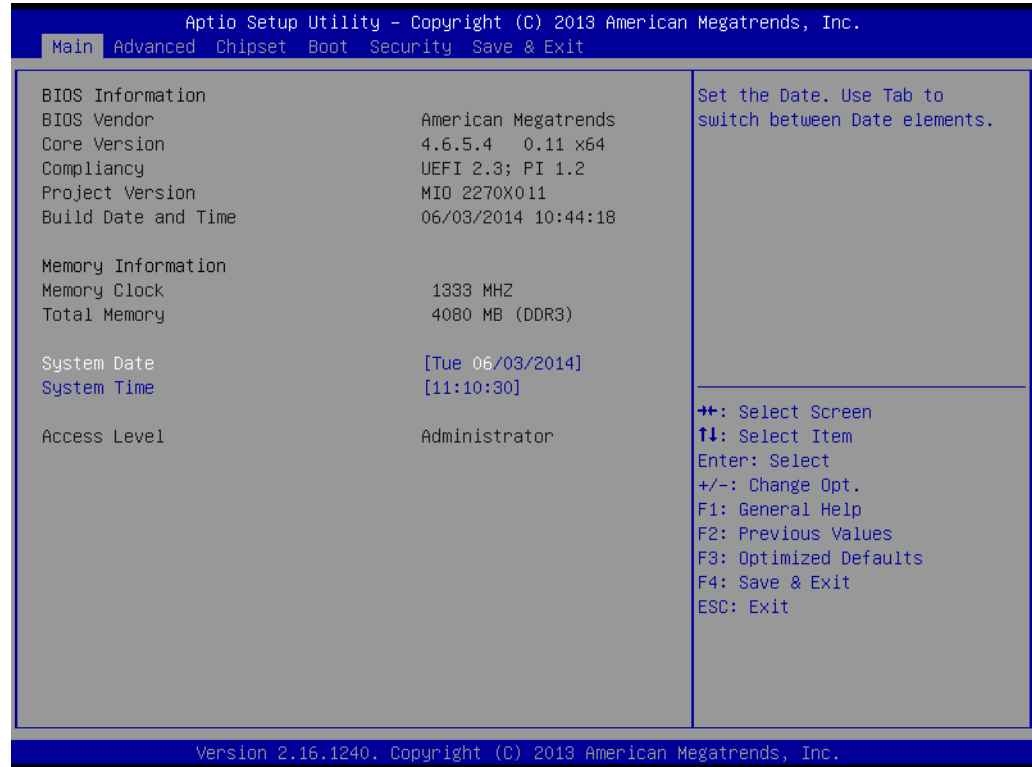

AMI's BIOS ROM has a built-in setup program that allows users to modify the basic system configuration. This information is then stored in flash ROM to ensure that the setup information is retained even when the system is powered off.

3.2 Entering the Setup Menu

Power on the computer and press <F2> or to enter the setup menu.

3.2.1 Main Setup Menu

When first entering the BIOS Setup Utility, users are directed to the Main setup page. Users can return to the Main setup page at any time by selecting the Main tab. The Main setup menu features two options, which are explained in this section. The Main BIOS setup page is shown below.



The Main BIOS setup page comprises two main frames. All configurable options are displayed in the left frame. Grayed-out options cannot be configured, whereas the options presented in blue can be configured. The key legend is displayed in the right frame.

Above the key legend is an area reserved for text messages. When an option is selected in the left frame, the colour of the text changes to white and is typically accompanied by a text message.

■ System Time / System Date

Use this option to change the system time and date. Highlight System Time or System Date using the <Arrow> keys. Enter new values using the keyboard. Press the <Tab> or <Arrow> keys to move between fields. The date must be entered in MM/DD/YY format. The time must be entered in HH:MM:SS format.

3.2.2 Advanced BIOS Features

Select the Advanced tab of the BIOS Setup Utility menu to access the Advanced BIOS setup page. Users can select any item, such as CPU Configuration, in the left frame of the screen to access the submenu for that item. Users can view the Advanced BIOS setup options by highlighting various items using the <Arrow> keys. All Advanced BIOS setup options are described in this section. The Advanced BIOS setup screens are shown below, and the submenus are described in subsequent sections.

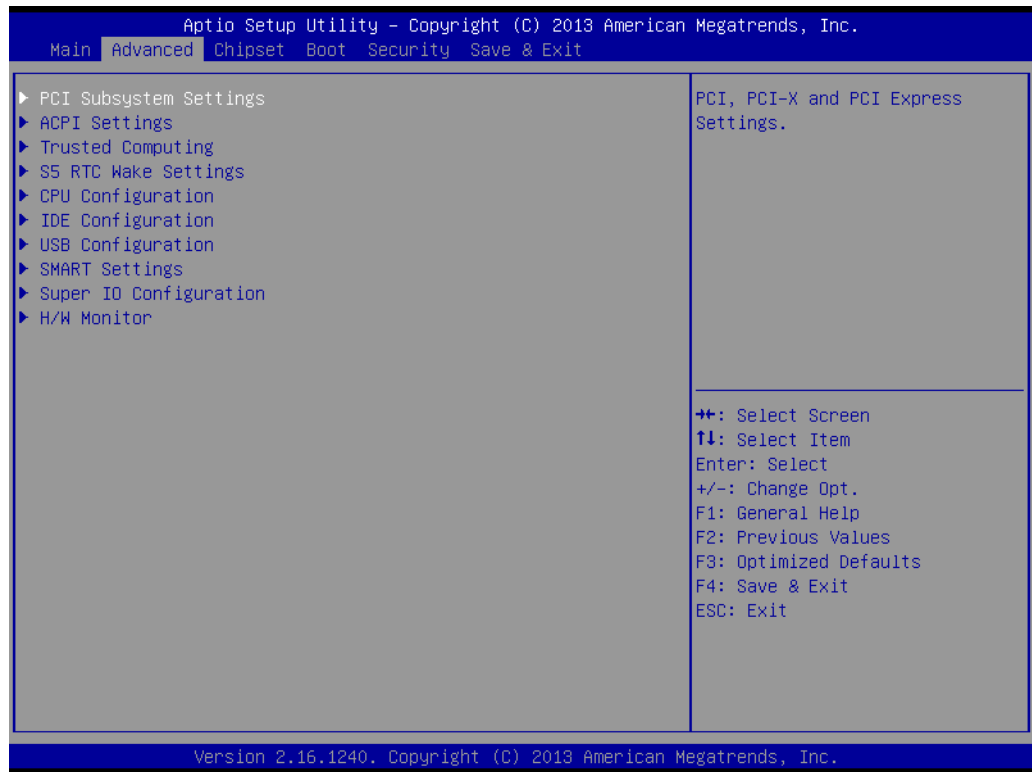

3.2.2.1 PCI Subsystem Settings Configuration

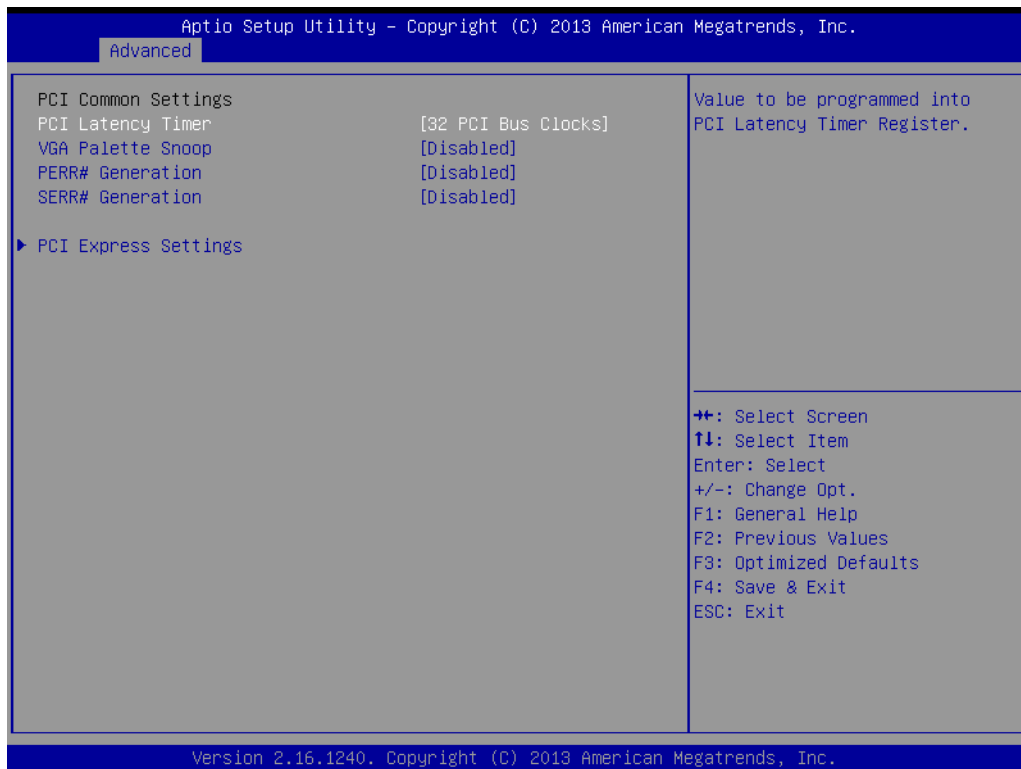

- **PCI Latency Timer**
This item allows users to select the 32 / 64 / 96 / 128 / 160 / 192 / 224 / 248 PCI bus clocks.
- **VGA Palette Snoop**
This item allows users to enable or disable snooping of VGA palette registers.
- **PERR# Generation**
This item allows users to enable or disable PCI device PERR# generation.
- **SERR# Generation**
This item allows users to enable or disable PCI device SERR# generation.
- **PCI Express Settings**
This item allows users to configure the PCI Express device settings.

3.2.2.2 ACPI Settings Configuration

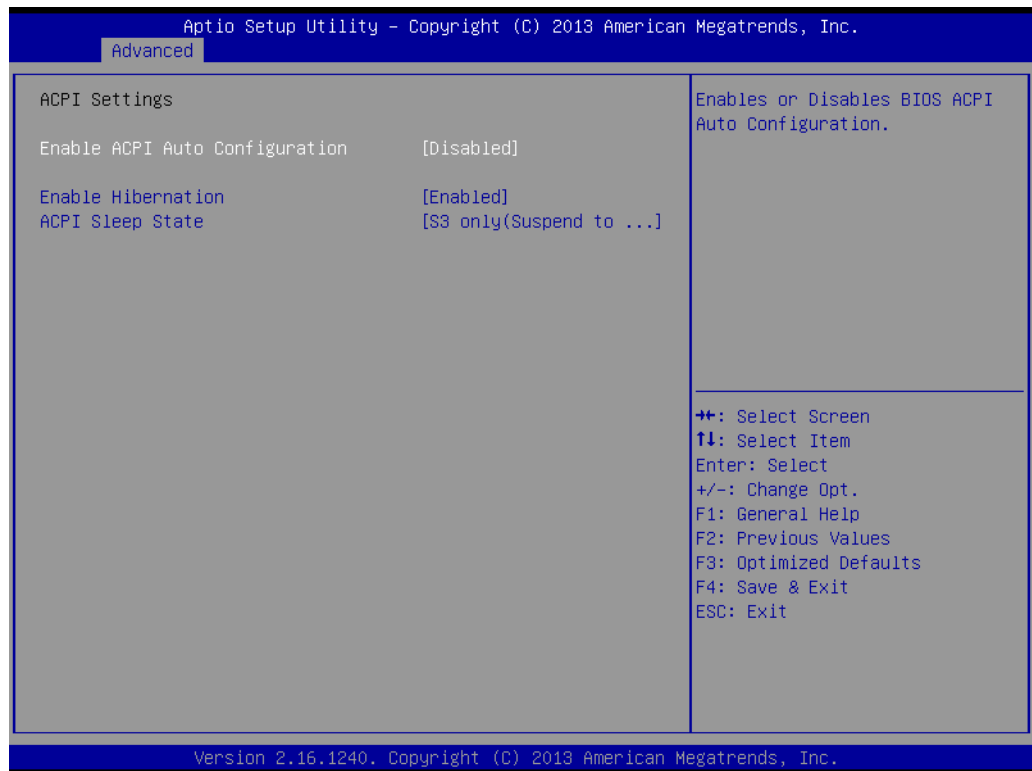

- **Enable ACPI Auto Configuration**
This item allows users to enable or disable BIOS ACPI auto configuration.
- **Enable Hibernation**
This item allows users to enable or disable the hibernation function (if supported by the OS).
- **ACPI Sleep State**
This item allows users to select the ACPI states used for system suspension.

3.2.2.3 Trusted Computing

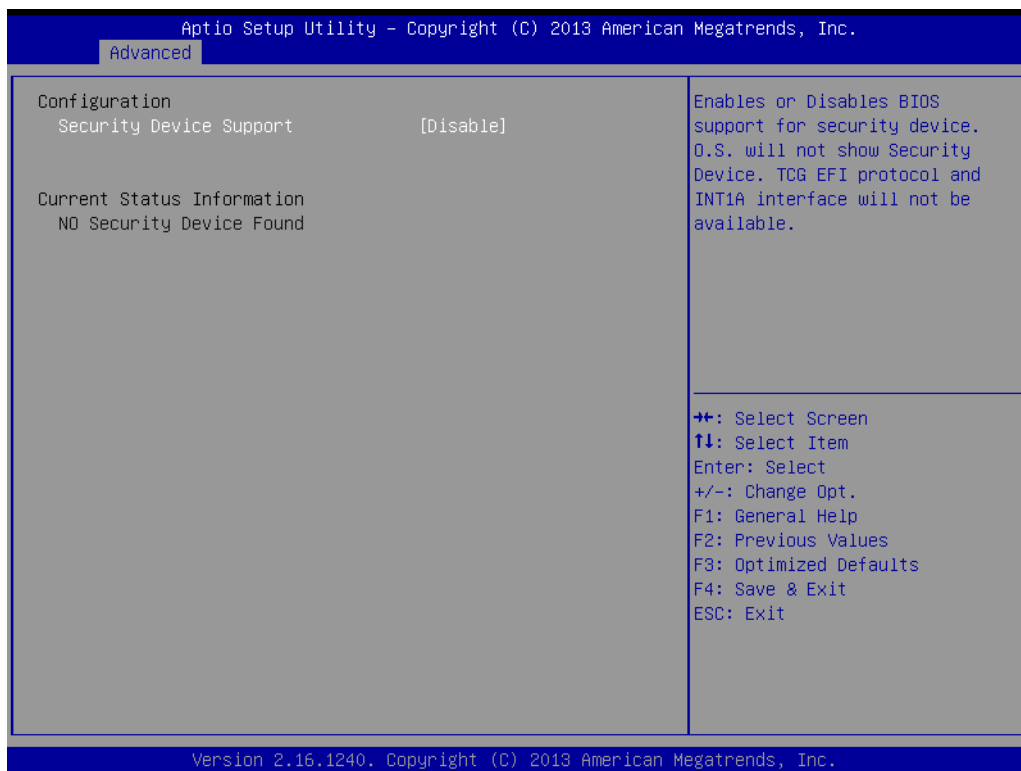

- **TPM Support**

This item allows users to enable or disable TPM support for security.

3.2.2.4 S5 RTC Wake Settings

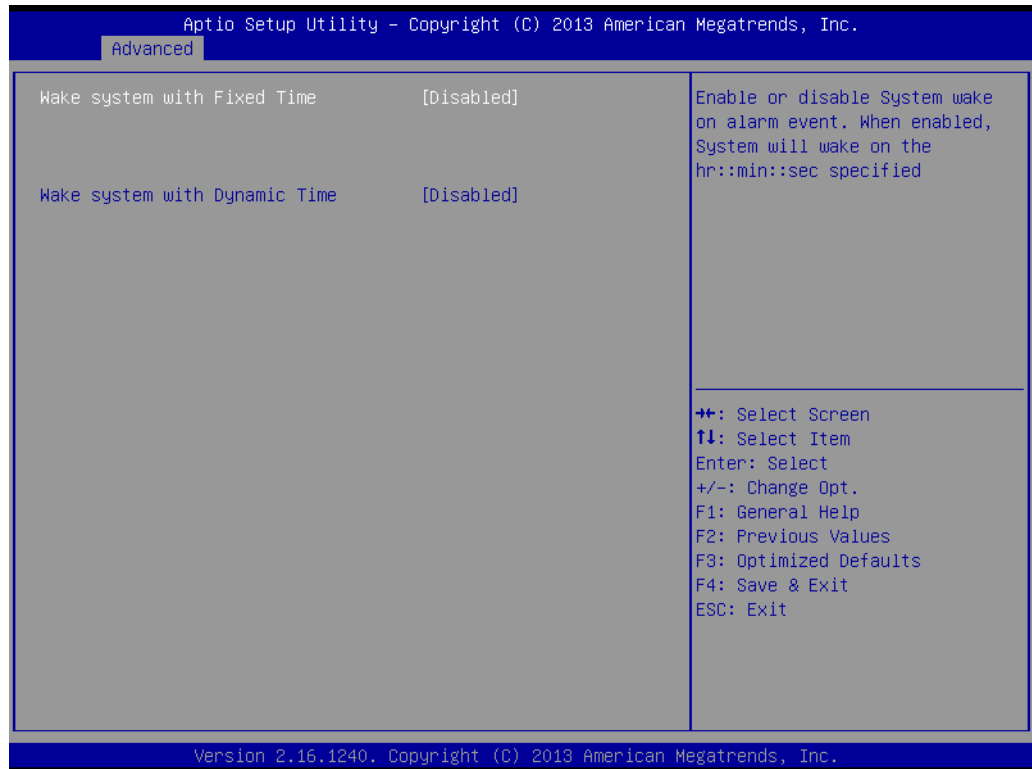

- **Wake System with Fixed Time**
This item allows users to enable or disable system wake on alarm event.
- **Wake System with Dynamic Time**
This item allows users to enable or disable system wake on alarm event, and to set a delay interval of between 1 to 5 minutes.

3.2.2.5 CPU Configuration

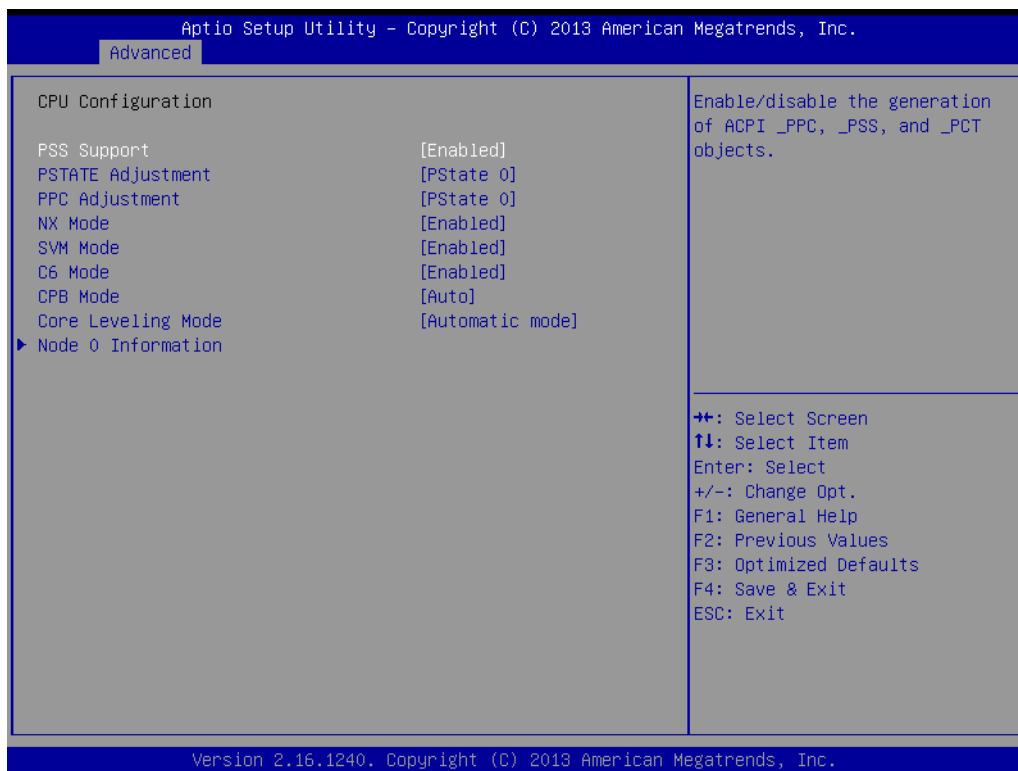

- **PPS Support**
This item allows users to enable or disable ACPI _PPC, _PSS, and _PCT objects.
- **PSTATE Adjustment**
This item allows users to specify the P-state level.
- **PPC Adjustment**
This item allows users to specify the _PPC object.
- **NX Mode**
This item allows users to enable or disable the No-execute page protection function.
- **SVM Mode**
This item allows users to enable or disable CPU virtualization.
- **C6 Mode**
This item allows users to auto enable or disable C6 function.
- **CPB Mode**
This item allows users to auto enable or disable CPB.
- **Node 0 Information**
This item allows users to view the memory data related to Node 0.

3.2.2.6 IDE Configuration

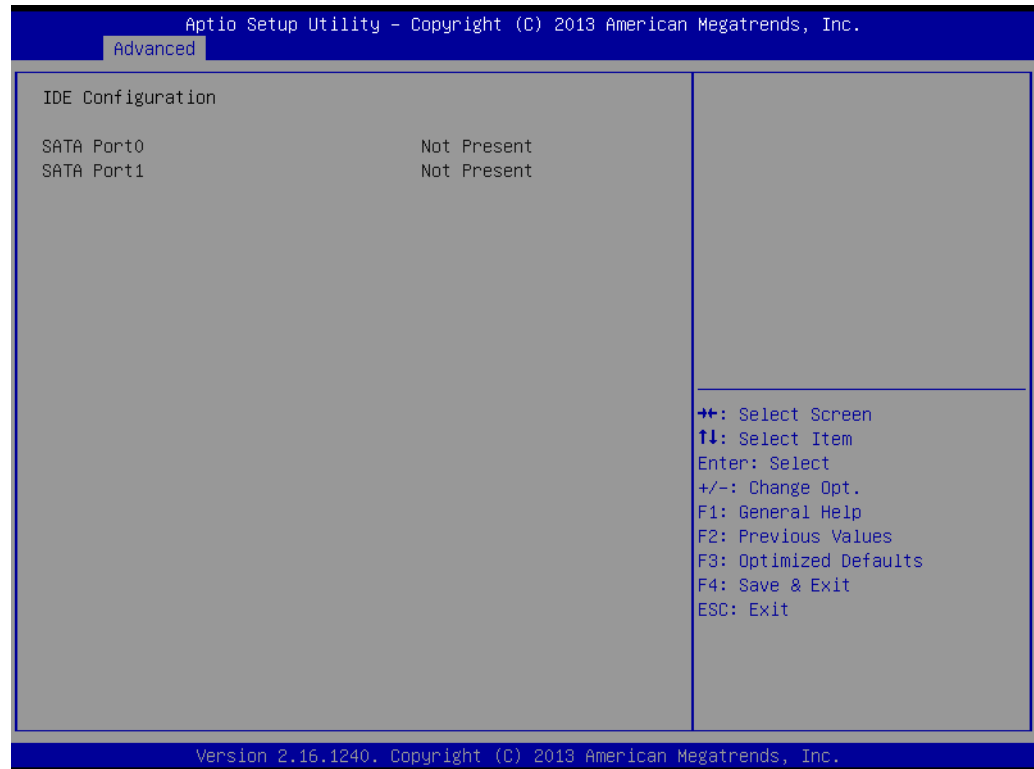

- **IDE Configuration**

This item allows users to view SATA Port 0 / Port 1 information.

3.2.2.7 USB Configuration

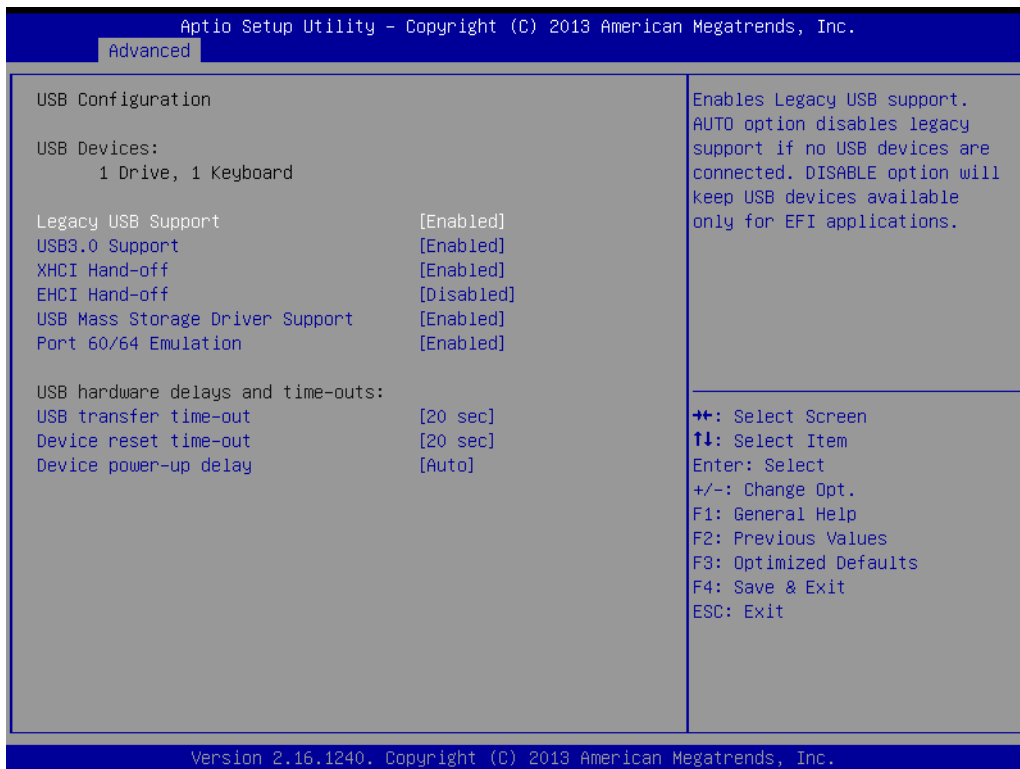

- **Legacy USB Support**
This item allows users to enable support for legacy USB. The auto option disables legacy support if no USB devices are connected.
- **USB3.0 Support**
This item allows users to enable or disable USB3.0 (XHCI) function.
- **XHCI Hand-Off**
This item is a workaround for OS without XHCI hand-off support. The XHCI ownership change should be claimed by the XHCI driver.
- **EHCI Hand-Off**
This item is a workaround for OS without EHCI hand-off support. The EHCI ownership change should be claimed by the EHCI driver.
- **USB Mass Storage Driver Support**
This item allows users to enable or disable USB mass storage device support.
- **Port 60/64 Emulation**
This item allows users to enable or disable I/O port 60h/64h emulation support.
- **USB Transfer Time-Out**
This item allows users to specify the timeout value for control, bulk, and interrupt transfers.
- **Device Reset Time-Out**
This item allows users to specify the USB mass storage device start command timeout value.
- **Device Power-Up Delay**
This item allows users to specify the maximum time before the device reports itself to the host controller.

3.2.2.8 SMART Settings

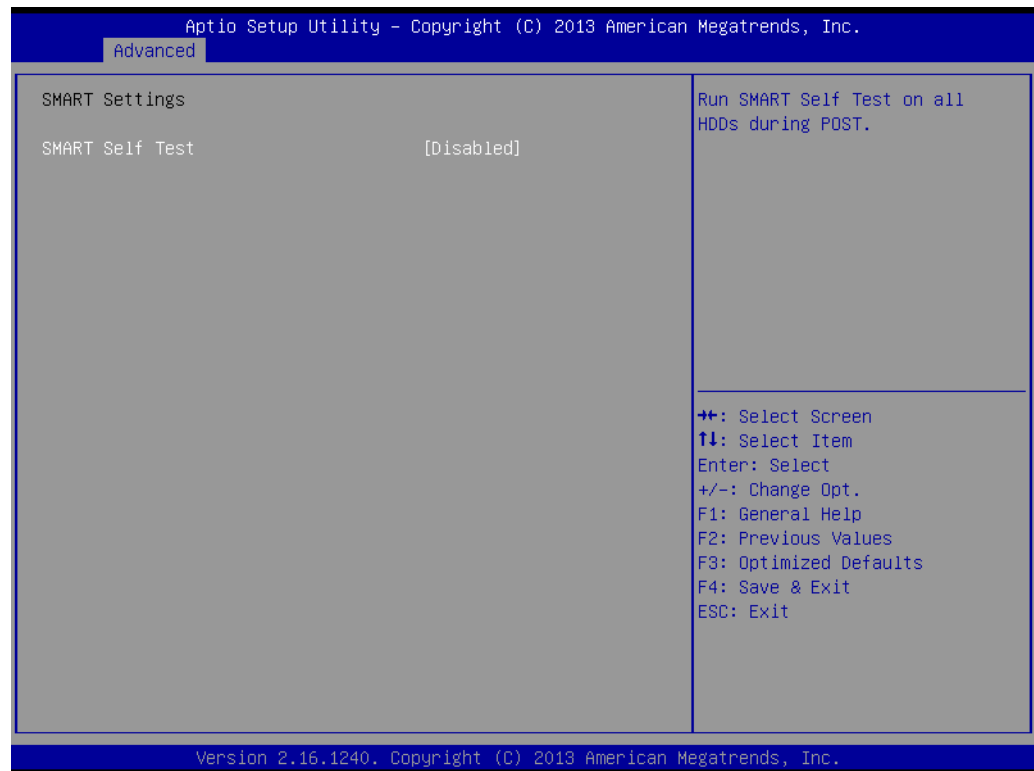

- **SMART Self Test**
This item allows users to enable or disable the SMART self-test function.

3.2.2.9 Super I/O Configuration

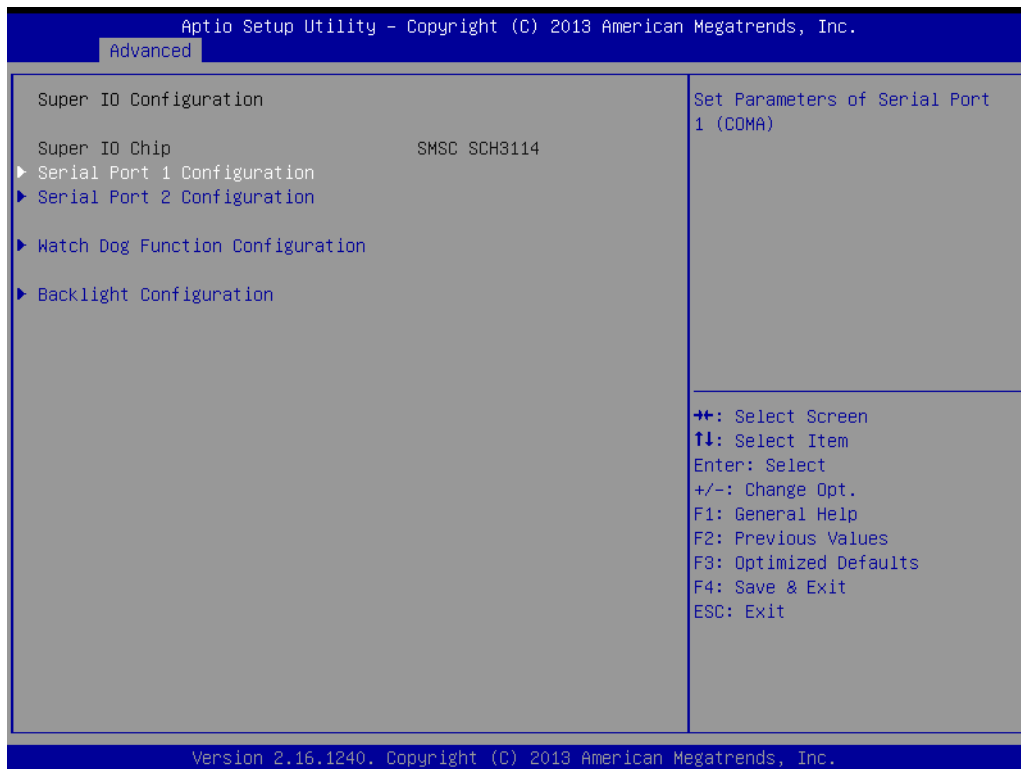

- **Serial Port 1 / Port 2 Configuration**
This item allows users to select serial Ports 1 or 2 and view their detailed functions.
- **Watch Dog Function Configuration**
This item allows users to enable or disable the watchdog timer function.
- **Backlight Configuration**
This item allows users to select the backlight mode.

3.2.2.10 H/W Monitor

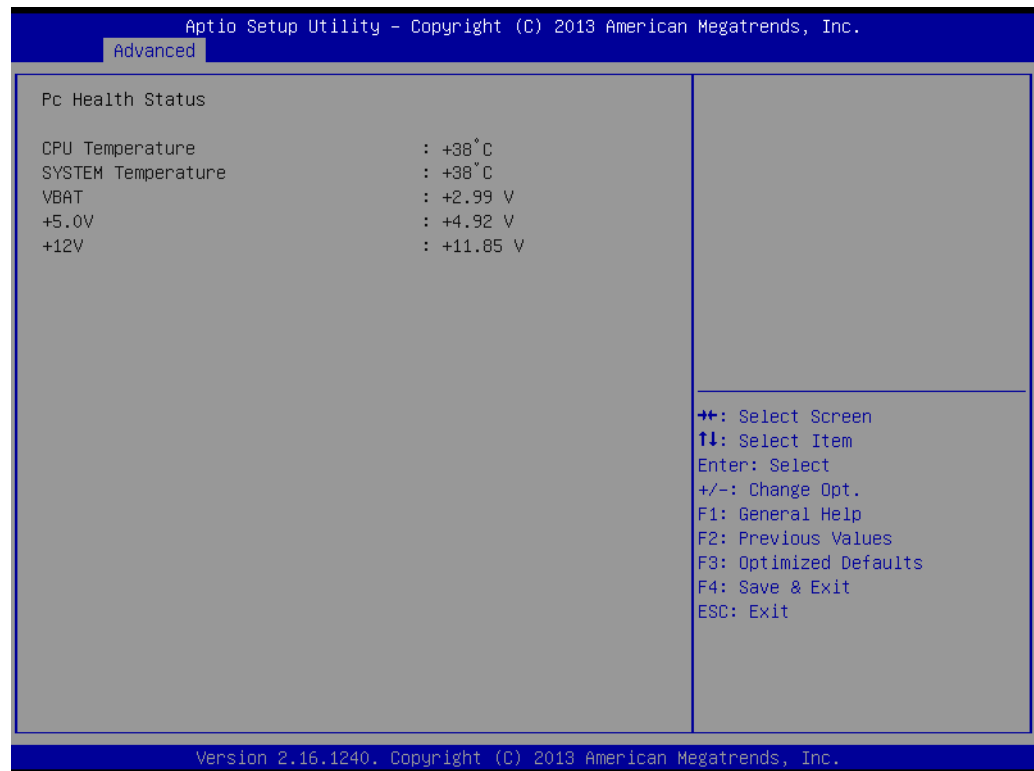

- **PC Health Status**
This page displays the system temperature and voltage information.

3.2.3 Chipset Configuration

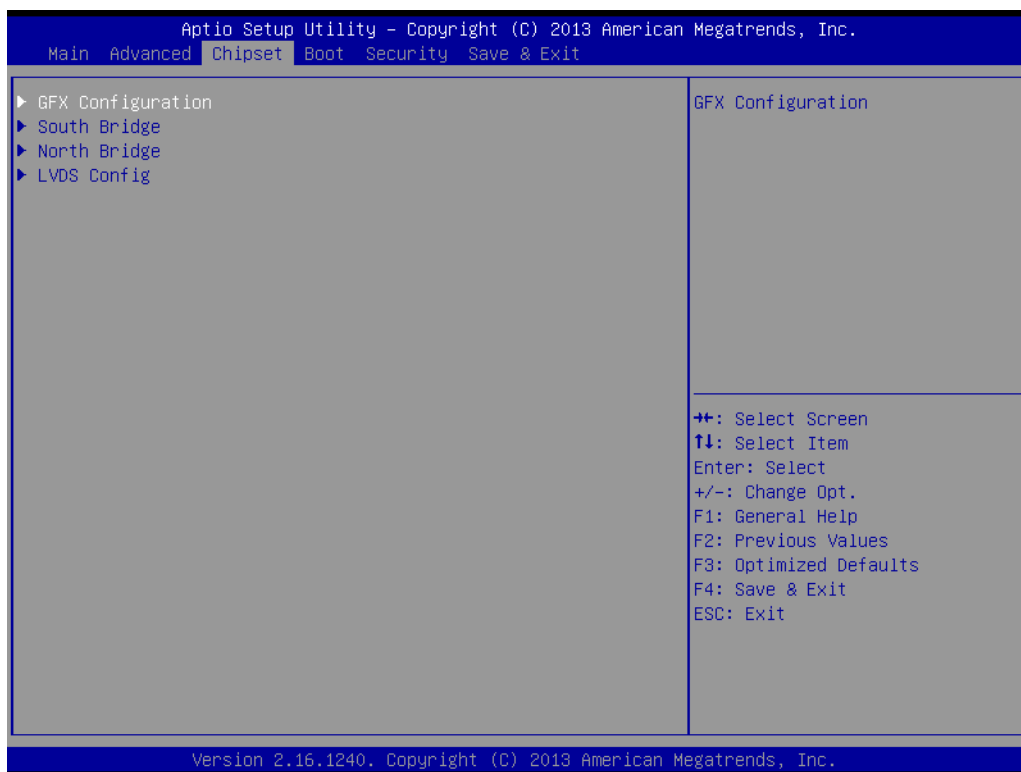

- **GFX Configuration**
This item allows users to view the options for GFX items.
- **South Bridge**
This item allows users to view the options for South Bridge items.
- **North Bridge**
This item allows users to view the options for North Bridge items.
- **LVDS Config**
This item allows users to configure the various display options.

3.2.3.1 GFX Configuration

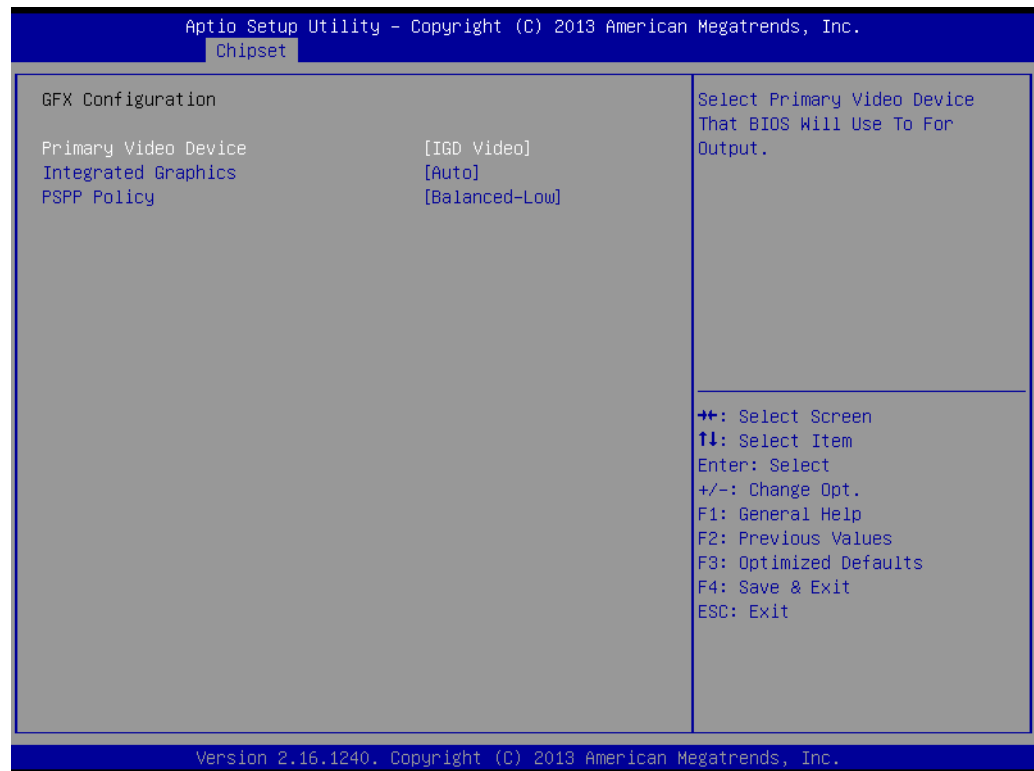

- **Primary Video Device**
This item allows users to specify the primary video device for first output.
- **Integrated Graphics**
This item allows users to enable or disable the integrated graphics controller.
- **PSPP Policy**
This item allows users to specify the PCIe speed power policy.

3.2.3.2 South Bridge Configuration

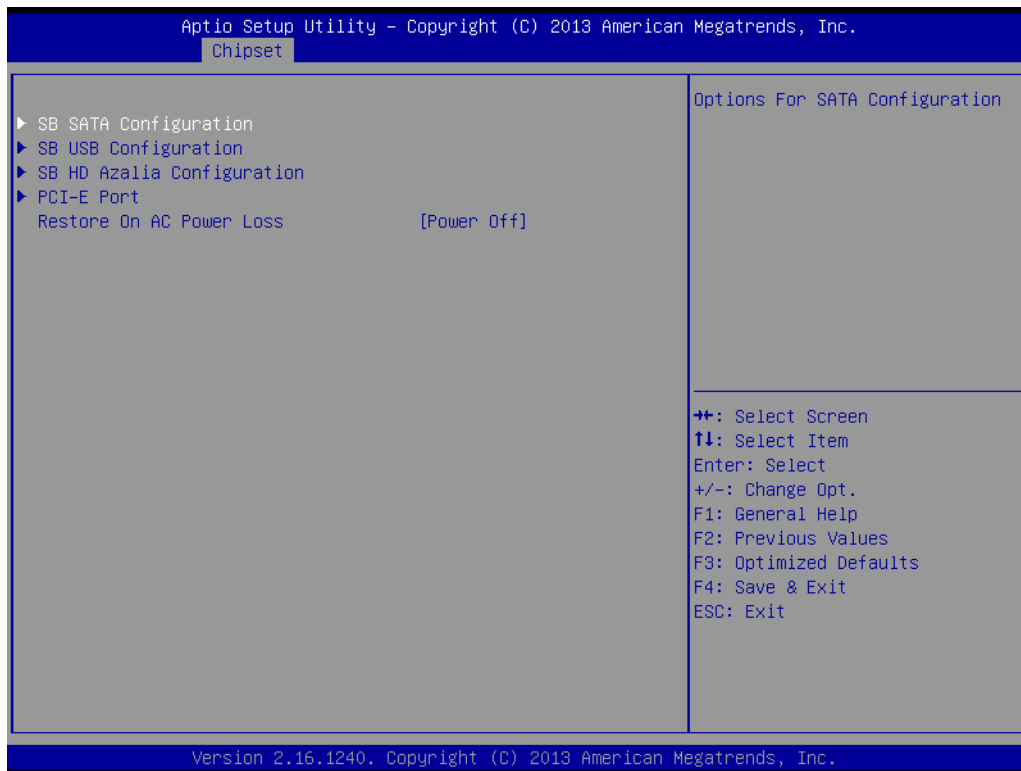

- **SB SATA Configuration**
This item allows users to configure the SB SATA options.
- **SB USB Configuration**
This item allows users to configure the SB USB options.
- **SB HD Azalia Configuration**
This item allows users to configure the SB HD Azalia options.
- **PCI-E Port**
This item allows users to configure the PCI-E device control options.
- **Restore on AC Power Loss**
This item allows users to select the system restore states in the event of an AC power loss.

3.2.3.3 North Bridge Configuration

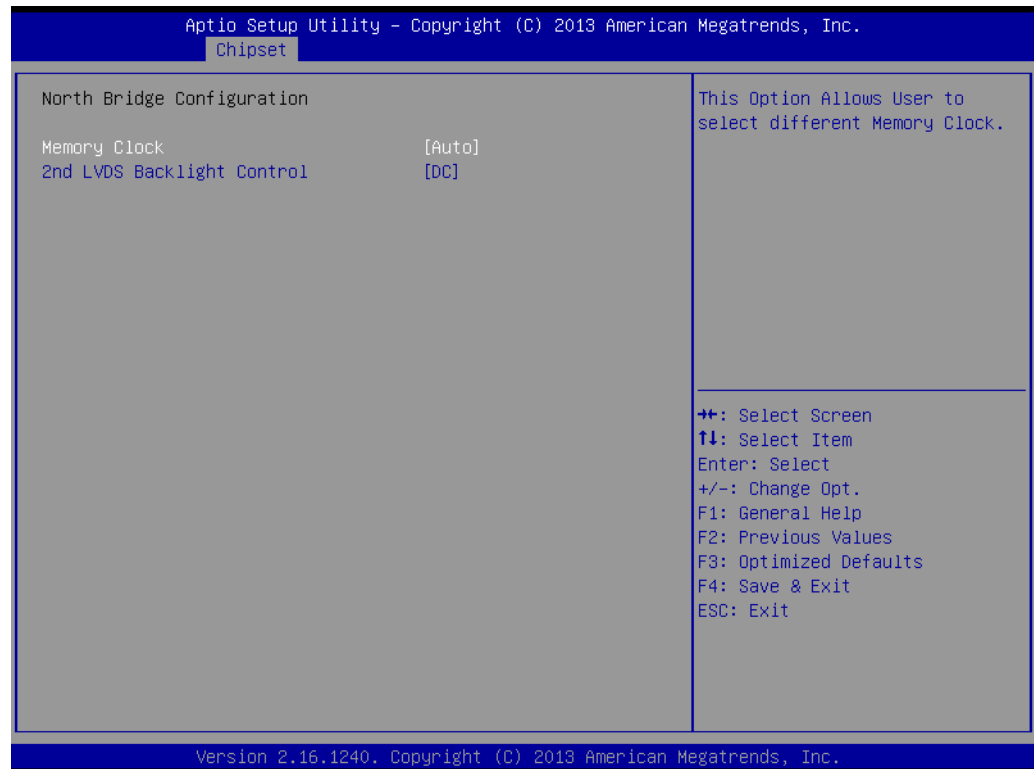

- **Memory Configuration**
This item allows users to specify the memory frequency.
- **2nd LVDS Backlight Control**
This item allows users to select the LVDS backlight mode.

3.2.3.4 LVDS Configuration

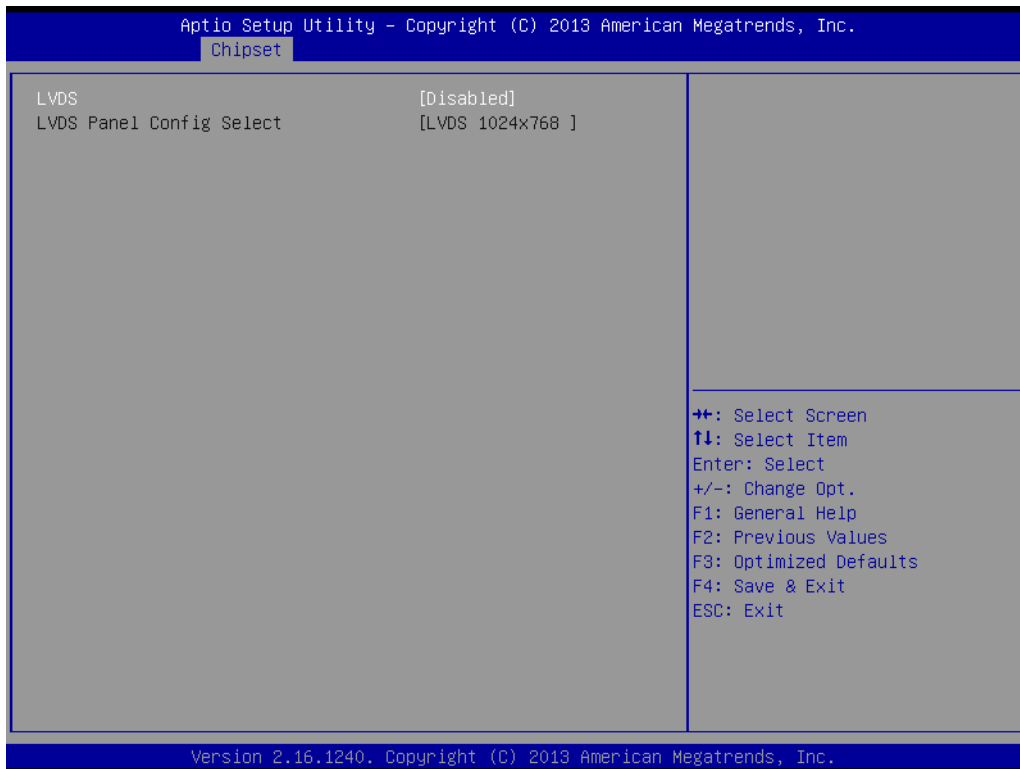

- **LVDS**
This item allows users to enable or disable the LVDS panel function.
- **LVDS Panel Config Select**
This item allows users to select the LVDS panel resolution type.

3.2.4 Boot Configuration

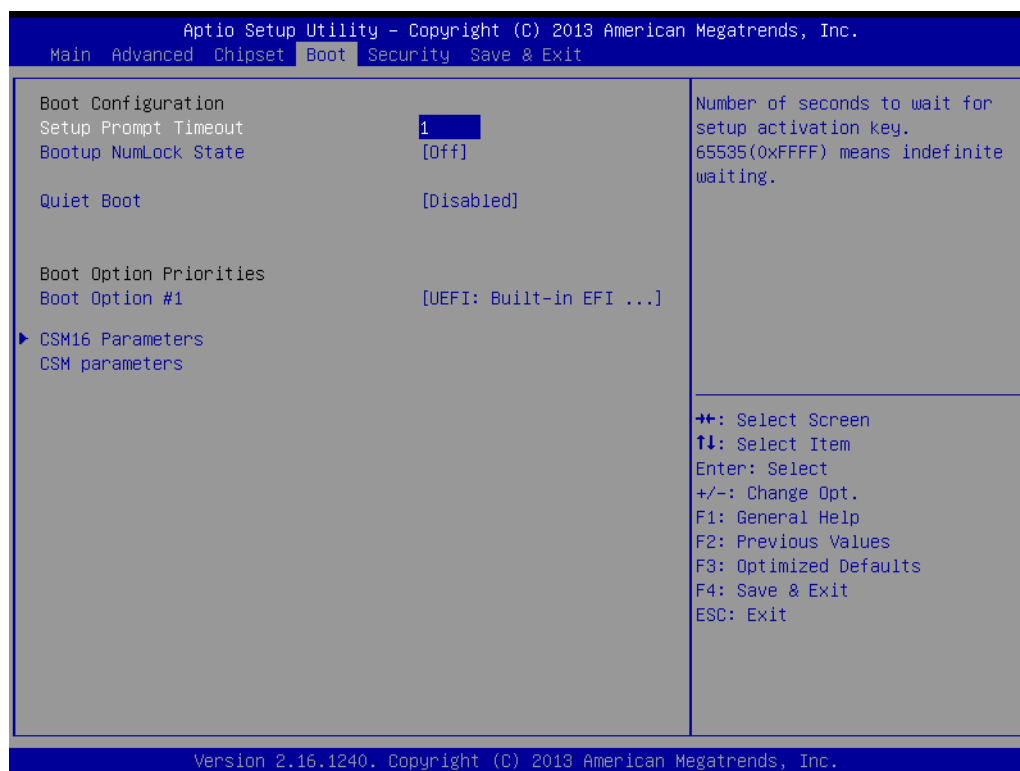

- **Setup Prompt Time-out**
This item allows users to set the setup activation key wait duration (in seconds).
- **Bootup NumLock State**
This item allows users to select the power-on state for Numlock.
- **Quiet Boot**
When this option is set to "Disabled", the BIOS system displays standard POST messages. If set to "Enabled", an OEM Logo is displayed instead of POST messages.
- **CSM16 Parameters**
This item allows users to adjust the "GateA20 Active", "Option ROM Messages", and "INT19 Trap Response" function settings.
- **CSM Parameters**
This item allows users to enable or disable CSM support and OpROM policy.

3.2.5 Security Configuration

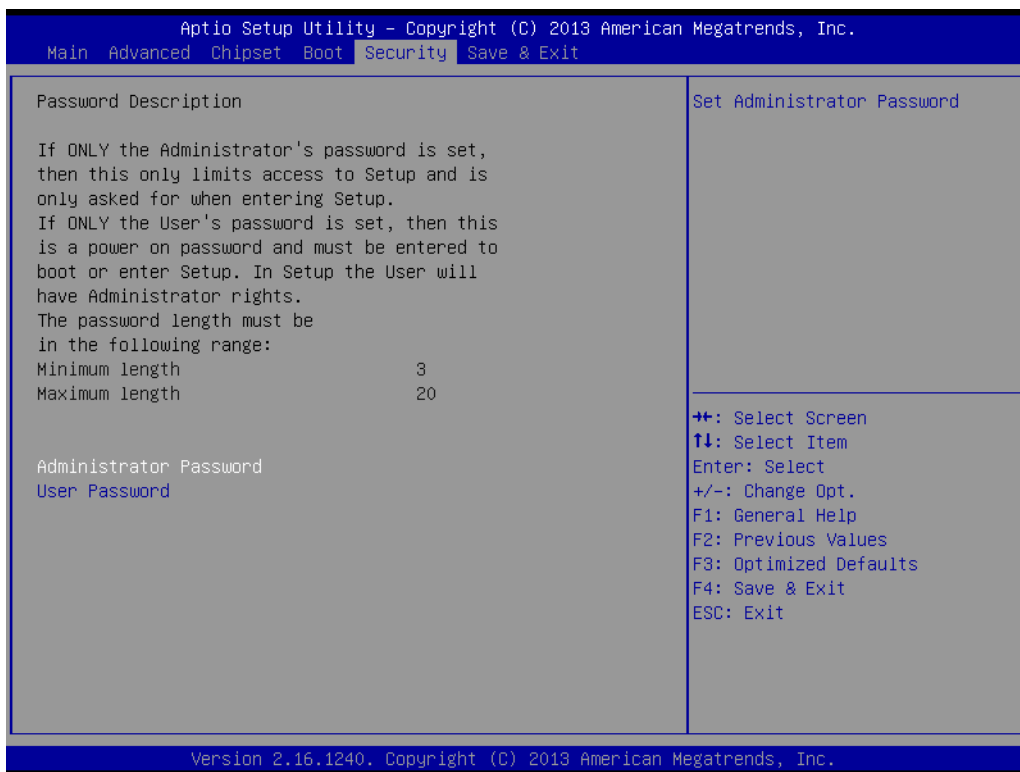

Select the Security tab from the main BIOS Setup Utility menu. All security setup options, such as password and virus protection, can be accessed from this menu. To access the submenu of any item, select the item and press <Enter>.

- **Change Administrator / User Passwords**

Select this item and press <Enter> to access the item submenu and set access passwords.

3.2.6 Save and Exit

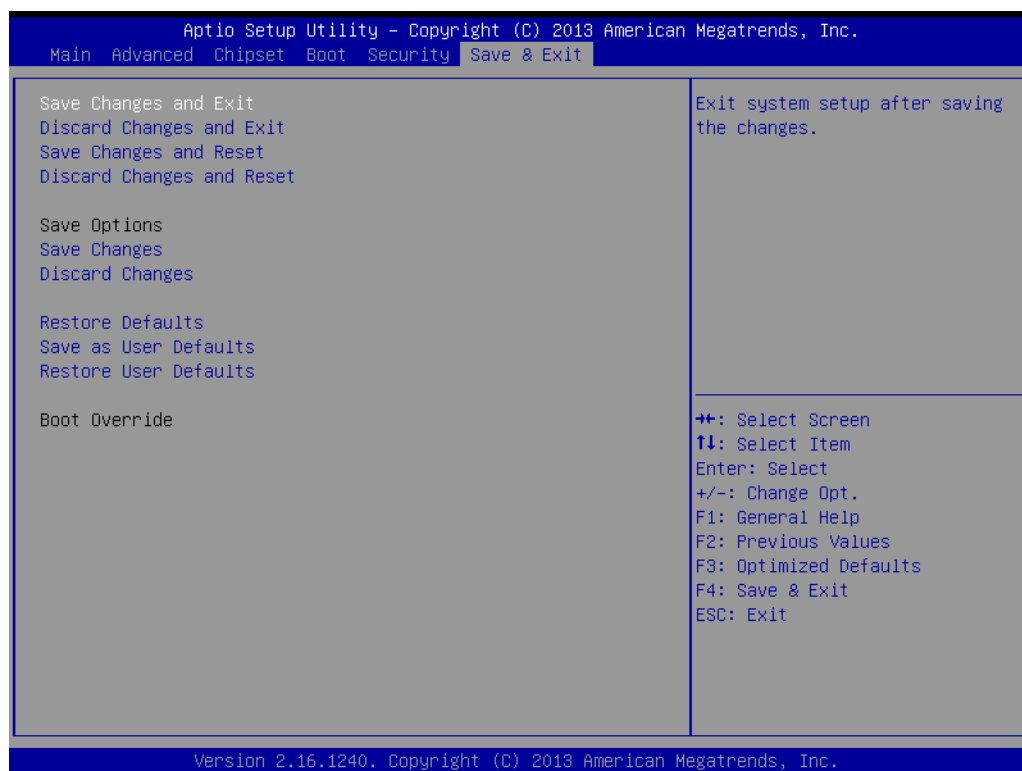

- **Save Changes and Exit**
This item allows users to save changes and exit the setup menu.
- **Discard Changes and Exit**
This item allows users to exit the setup menu without saving changes.
- **Save Changes and Reset**
This item allows users to save changes and reset the system.
- **Discard Changes and Reset**
This item allows users to reset the system without saving changes.
- **Save Changes**
This item allows users to save all changes.
- **Discard Changes**
This item allows users to discard all changes.
- **Restore Defaults**
This item allows users to restore/load the default values for all options.
- **Save as User Defaults**
This item allows users to save all changes as user defaults.
- **Restore User Defaults**
This item allows users to restore the user defaults for all options.
- **Boot Override**
This item allows users to override the boot device priority specifications.

Chapter 4

S/W Introduction and
Installation

4.1 S/W Introduction

The purpose of Advantech's embedded software services is to enhance the ease of using Advantech platforms and Microsoft® Windows® embedded technology. Advantech platforms are designed to support Windows embedded software products to effectively accommodate all the needs of the embedded computing community. For customers, this eliminates the hassle of dealing with multiple vendors (hardware suppliers, system integrators, and/or embedded OS distributors). Our goal is to ensure that Windows embedded software solutions are widely available to the embedded computing community.

4.2 Driver Installation

4.2.1 Windows 7 Professional

To install the necessary drivers, insert the driver CD into the DVD-ROM, select the drivers for installation, then launch the setup file in each function folder. Follow the Driver Setup instructions to complete all installations.

4.2.2 Alternate OS

To install drivers for another Windows OS or Linux, locate the appropriate setup file for the specific OS.

4.3 Value-Added Software Services

Software APIs can be used to define how an application program requests services from libraries and/or an OS. These interfaces not only specify the required drivers, but also provide numerous user-friendly, intelligent, and integrated interfaces, thereby speeding up development, enhancing security, and offering add-on value to Advantech platforms.

4.3.1 SUSI Introduction

To provide programmers with easy and convenient access to hardware, Advantech developed an API suite in the form of a program library. This program library is known as the Secured and Unified Smart Interface, and is referred to as SUSI.

With contemporary OS, user applications cannot access the hardware directly, necessitating the use of drivers. User applications can only access the hardware through drivers. Because the driver interface typically varies for different OS, user application requests for hardware access differ between various OS. However, an abstraction layer can be built on top of the drivers to provide a uniform interface for accessing hardware. SUSI is an example of this type of abstraction layer. SUSI provides a uniform API for application programmers to access hardware functions using different OS and Advantech hardware platforms.

Application programmers can initiate the functions supported by SUSI rather than requesting the drivers directly. The benefit of using SUSI is portability. Specifically, the same APIs can be defined for different Advantech hardware platforms and implemented on different OS. This user manual describes several sample programs as well as SUSI and the APIs. The hardware functions supported by SUSI, such as watchdog timer, SMBus, GPIO, and VGA control, can be grouped into categories. The APIs for each category are briefly described in the following section.

4.3.2 Software APIs

4.3.2.1 GPIO API

The General Purpose Input/Output (GPIO) API is a flexible parallel interface that enables various custom connections and allows users to monitor the signal input level or set the output status to switch on/off a device. This API also facilitates programmable GPIO, which allows developers to dynamically set the GPIO input or output status.

4.3.2.2 SMBus API

The System Management Bus (SMBus) API is a two-wire interface established by Intel Corporation in 1995, based on the same operation principles of I²C, and used in personal computers and servers for low-speed system management communications. At present, SMBus is incorporated in many types of embedded systems. Similar to other SUSI APIs, the SMBus API is available on numerous platforms including Windows 7.

4.3.2.3 Display Control API

Two VGA control APIs exist; one for backlight on/off control, and one for brightness control. These APIs allow developers to turn the backlight on or off and to control the brightness.

1. Brightness Control
 - The Brightness Control API allows developers to interface with an embedded device and adjust the display brightness.
2. Backlight Control
 - The Backlight API allows developers to control the backlight (screen) of an embedded device.

4.3.2.4 Watchdog API

A watchdog timer (WDT) is a hardware device that triggers a specific action, e.g., system reboot, if the system does not reset the timer within a specified period of time. The WDT API in SUSI enables developers to start the timer, reset the timer, and set the timeout value for hardware that requires customized timeout values.

4.3.2.5 Hardware Monitor API

The hardware monitor (HWM) enables system health supervision using I/O chips combined with sensors to monitor certain condition indices, such as fan speed, temperature, voltage, etc.

However, because of the inaccuracy of many commercial hardware monitoring chips, Advantech developed a unique scheme for hardware monitoring; that is, using a dedicated microprocessor and specifically designed algorithms to provide accurate and reliable real-time data to ensure system protection.

4.3.2.6 Power Saving API

1. CPU Speed
 - The Power Saving API uses Intel SpeedStep® technology to reduce the system power consumption. The CPU speed is automatically adjusted according to the system load.
2. System Throttling
 - System throttling refers to various methods for reducing power consumption by lowering the clock frequency. The Power Saving API allows users to reduce the clock frequency from 87.5% to 12.5%.

4.3.3 SUSI Installation

SUSI supports numerous OS. The steps for installing SUSI and related software on various OS are described in the following subsections. Please refer to the information provided for your specific OS.

4.3.3.1 Windows 7

In Windows 7, the library, drivers, and demo programs can be easily installed on the platform using the SUSI Library Installer. After executing the installation tool, users can access the SUSI Library and related files for Windows 7 in the target installation directory. The files that should be in the directory are listed in the following table:

Directory	Contents
\Library	<ul style="list-style-type: none">■ Susi.lib Library for developing applications on Windows 7.■ Susi.dll Dynamic library for SUSI on Windows 7.
\Demo	<ul style="list-style-type: none">■ SusiDemo.exe Demo program on Windows 7.■ Susi.dll Dynamic library for SUSI on Windows 7.
\Demo\SRC	Source code for the demo program on Windows 7.

The installation process is demonstrated in the figures presented in the subsequent section.

Note! *The screen shots of the SUSI Library Installer installation process shown below are only examples. The information output to your screen may differ depending on your OS.*



1. Extract files from Susi.zip.
2. Double click the "Setup.exe" file.

The installer first searches for a previous installation of the SUSI Library. If one is located, users are presented with the option to modify, repair, or remove the software. For systems installed with a previous version, please see the Maintenance Setup section for further instructions. If a previous installation is not located, users are presented with a different pop-up window. Click Next.

4.3.4 SUSI Sample Programs

Sample Programs

The sample programs provided demonstrate how to incorporate SUSI into a program. For the examples described in the following subsections, the sample programs were executed on Windows 7 in graphics mode.

Windows Graphics Mode

An executable “SusiDemo.exe” file, shared library “Susi.dll” file, and source code are provided for each demo application in the release package.

SusiDemo.exe is an executable file that equips the shared library, Susi.dll, with SUSI functionalities. The SusiDemo.exe source code should be compiled using Microsoft Visual C++ 6.0 in Windows 7. Developers must add the header (Susi.h) and library (Susi.lib) files to their project folders before using SUSI to develop programs.

SusiDemo.exe

The SusiDemo.exe test application uses all functions of the SUSI Library and features five main function blocks: Watchdog, GPIO, SMBus, and VGA control. The pop-up menu shown in the screenshot below appears SusiDemo.exe is executed. To select different test functions, click on the function tabs. Some function tabs may not be available for the test application if your platform does not support such functions. The steps for testing all functions of this application are described below.

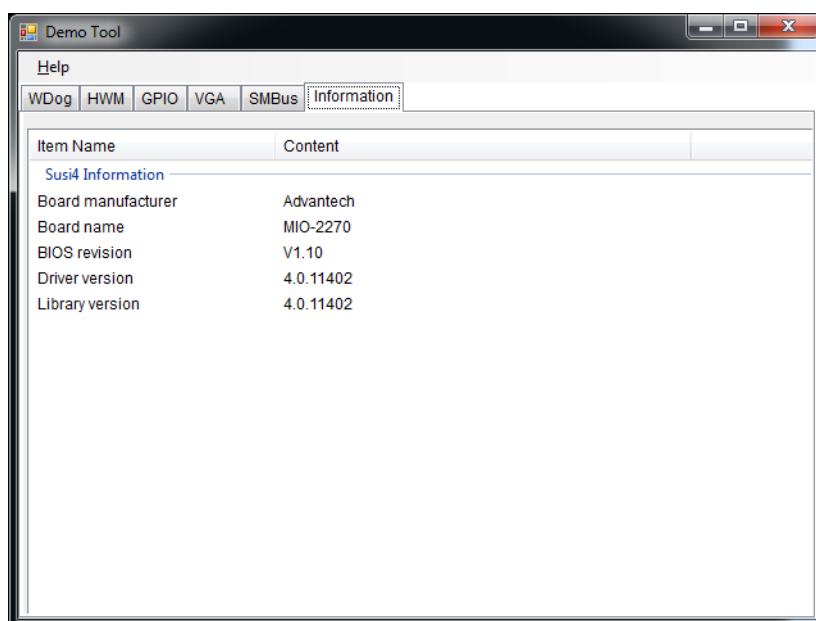

Information

This page details the system information gathered by SUSI.

Users can access this information to determine whether the SUSI Library and drivers have been installed and loaded successfully. The information presented on this page includes the application bootup and running times.

The “Driver version” and “Library version” data fields specify the SUSI version (4.0) and revision number (11402).

If problems are encountered, users are advised to send a screenshot of the Information page or the data displayed to their local FAE.

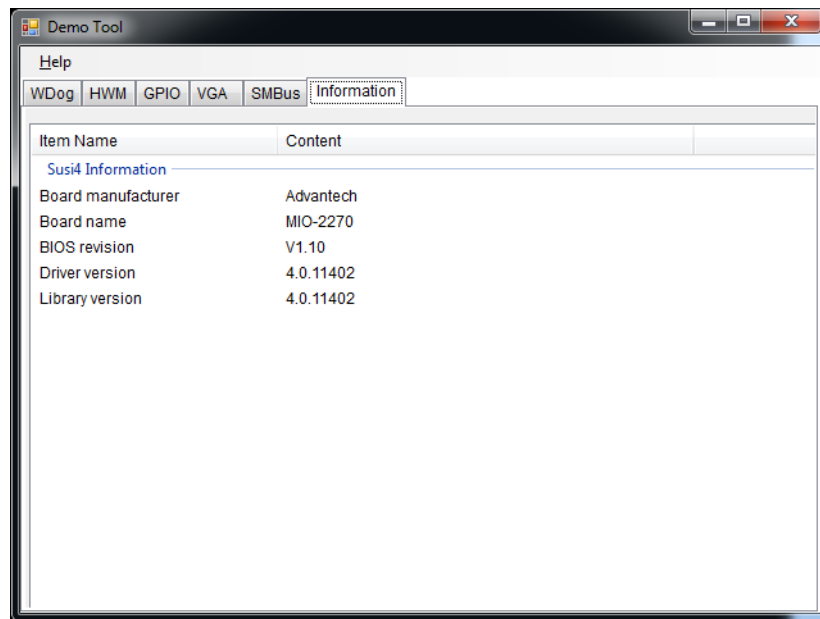

GPIO

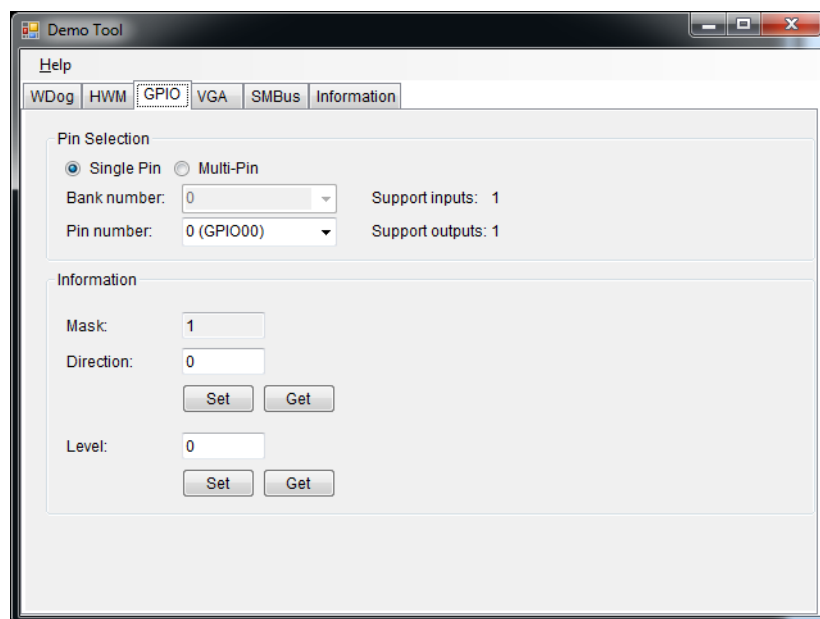

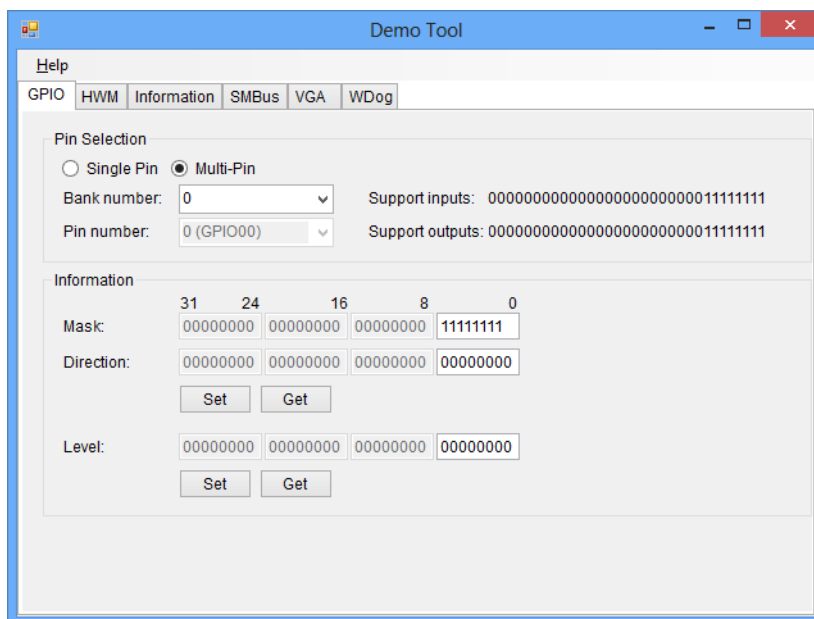

- **GPIO Pin Selection**
 - In **Single-Pin mode**, users can set and access one pin at a time. Select the pin number from the Pin number menu to set the pin and obtain its individual value. Pins are numbered from 0 to the total number of GPIO pins minus 1.
 - In **Multi-Pin mode**, users can set and access the entire bank of pins simultaneously. Select the pin bank number from the Bank number menu to set and obtain the values for an entire bank pins.
- **Supported Inputs/Outputs for GPIO Pins**
 - The supported inputs and outputs data indicate whether each pin is available or controllable as an input or output. A value of 1 indicates that the specified transmission direction is supported. In the example screenshot provided above, the board only supports eight GPIO pins in Bank 0.
- **Mask for GPIO Pins**
 - Masks are used to define which pins are enabled (Bit 1) or disabled (Bit 0) for setting or obtaining the direction and level.
 - Before setting the direction and level of GPIO pins, mask values should be specified. Zero cannot be set as the value for all masks.
- **Direction Setting**
 - The Direction value specifies the I/O direction of each pin; 1 denotes input and 0 denotes output.
 - Click the <Set/Get> button to set/get the Direction value.
- **Level Setting**
 - The Level value specifies the pin level; 1 denotes high level and 0 denotes low level.
 - Click the <Set/Get> button to set/get the Level value. If a pin direction is set as 1, the Level value cannot be specified.

Hardware Monitor

The Hardware Monitor displays the board voltage, temperature, fan speed, and current data collected by the hardware sensors, and records their minimum and maximum values.

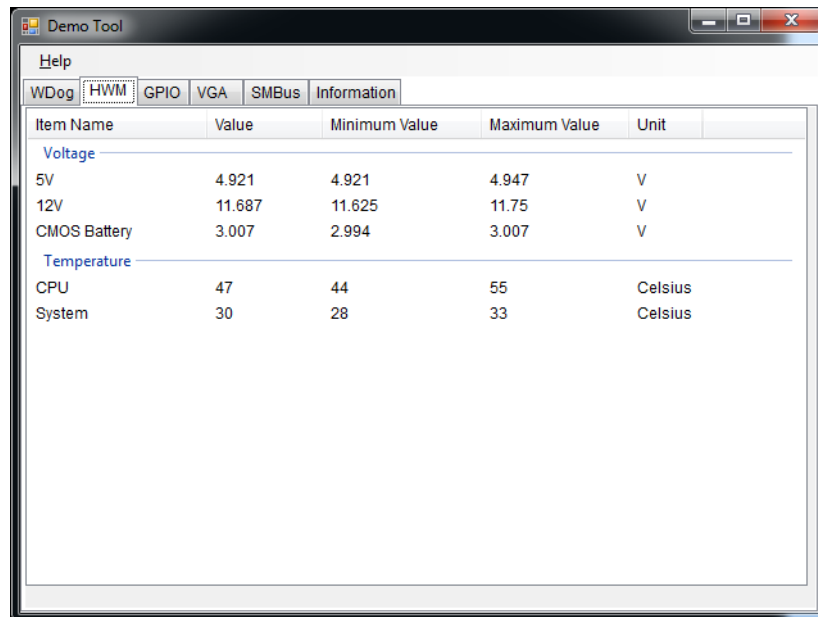

The screenshot shows the 'Demo Tool' window with the 'HWM' tab selected. The window displays a table of hardware monitor data. The table has columns for 'Item Name', 'Value', 'Minimum Value', 'Maximum Value', and 'Unit'. The data is organized into two sections: 'Voltage' and 'Temperature'.

Item Name	Value	Minimum Value	Maximum Value	Unit
Voltage				
5V	4.921	4.921	4.947	V
12V	11.687	11.625	11.75	V
CMOS Battery	3.007	2.994	3.007	V
Temperature				
CPU	47	44	55	Celsius
System	30	28	33	Celsius

SMBus

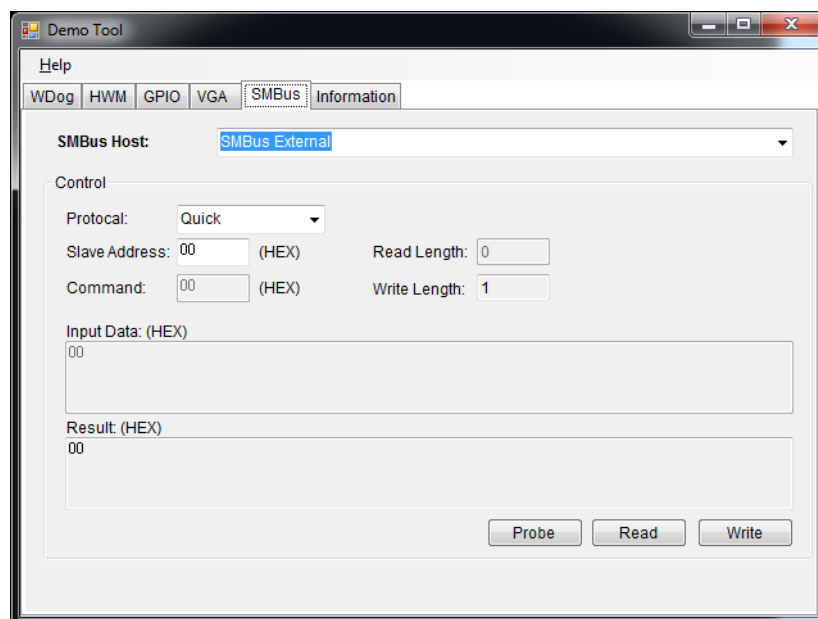

The screenshot shows the 'Demo Tool' window with the 'SMBus' tab selected. The window displays the SMBus configuration interface. The 'SMBus Host' is set to 'SMBus External'. The 'Control' section includes a 'Protocol' dropdown menu set to 'Quick', a 'Slave Address' field with '00 (HEX)', a 'Read Length' field with '0', a 'Command' field with '00 (HEX)', and a 'Write Length' field with '1'. Below these fields are 'Input Data: (HEX)' and 'Result: (HEX)' text areas, both containing '00'. At the bottom right, there are three buttons: 'Probe', 'Read', and 'Write'.

- **Starting SMBus**
 - Select a SMBus host before starting SMBus operation.
- **SMBus Protocol**
 - Choose one SMBus protocol from the options listed in the Protocol drop-down menu; supported protocols include Quick, Byte, Byte Data, Word Data, Block, and I2C Block.
 - For each protocol, the required value must be specified. If the protocol value is not required, the data field will be gray and uneditable.

- **SMBus Device Slave Address**
 - Input the slave address of a specific SMBus device in the Slave Address data field. Please refer to the “**Probe for SMBus Device**” subsection for instructions on how to obtain existing device addresses.
 - The Slave Address must be an eight-bit value, where the least bit is a “don't care” value. For example, if the address of a slave device is 0x69, insert D2 or D3. A setting of D2 (1101 0010) or D3 (1101 0011) provides the same results.
- **Read from SMBus Device**
 - Input the specific slave address and command. For more details regarding slave addresses, please refer to the “**Slave Address**” subsection.
 - Enter the desired data length in the Read Length data field. Click the Read option to initiate read/receive operations.
 - The read result is displayed in the Results data field.
- **Write to SMBus Device**
 - Input the specific slave address and command. For more details regarding slave addresses, please refer to the “**Slave Address**” subsection.
 - Enter the data to be written in the Input Data data field. Please see Notes 2 and 3 below regarding the Input Data and Write Length data fields.
 - Click the Write option to initiate write/send operations.
 - The write result is displayed in the Results data field.
- **Probe for SMBus Device**
- The Probe function enables users to scan for device addresses. Each address detected is the slave address of devices connected to the SMBus.
- The detected addresses are displayed in the Results data field in eight-bit format. For example, a slave address of 0x69 is displayed as D2.

- Note!**
1. *The required value must be specified. If the input value is not required, the data field will be gray and uneditable.*
 2. *For the Write Length data field, data entered into the Input Data data field is automatically counted and displayed as the Write Length value.*
 3. *For the Input Data data field, only [0-9], [a-f], [A-F], and space are allowed as input characters. When inputting multiple bytes of data, insert a space between each byte.*



VGA

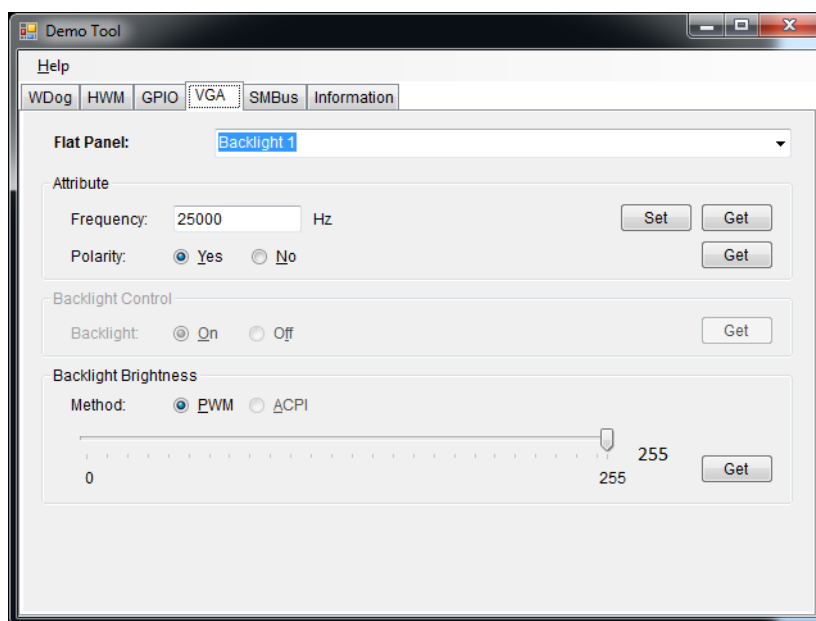

- **Initializing VGA**
 - Select the target panel from the Flat Panel drop-down menu.
 - Click <Get> for each item to obtain the current value.
- **Backlight Attribute Settings**
 - For frequency, click the Set/Get option to set/get the desired value.
 - For polarity, click Yes or No to turn the polarity on/off. If the polarity cannot be controlled, the Yes and No buttons will be unclickable.
- **Backlight On/Off**
 - For Backlight Control option, click On or Off to turn the backlight on/off. If the backlight function cannot be controlled, the On and Off buttons will be unclickable.
 - Click <Get> to view whether the current status is On or Off.
- **Brightness Adjustment**
 - For the Backlight Brightness Control option, click the PWM/ACPI button to set the brightness control method. If the backlight control method cannot be configured, this option will not be clickable.
 - Slide the seekbar to adjust the brightness value.
 - Click <Get> to obtain the current brightness value.

Watchdog Timer

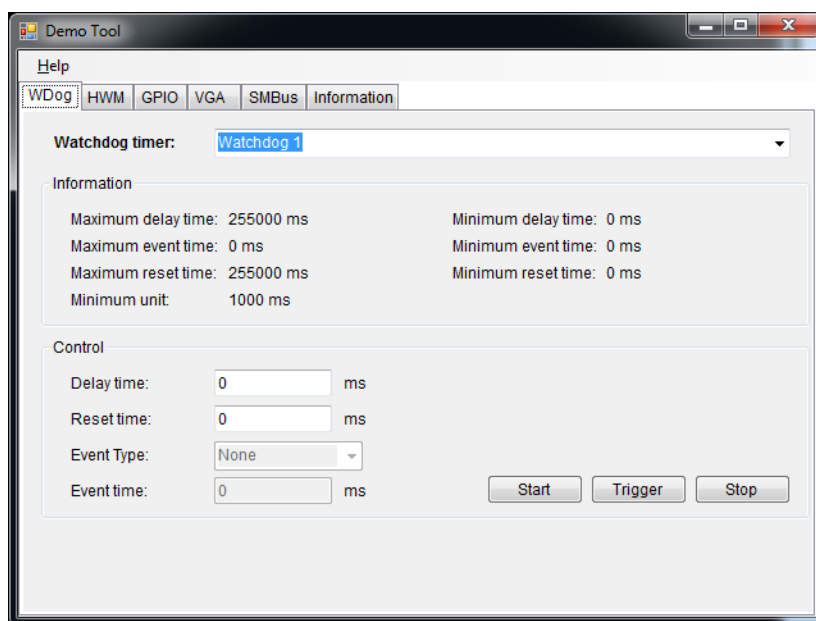

■ Time Setting Information

The watchdog timer information is displayed in the upper region of the pop-up window. This data includes the minimum value supported, maximum and minimum delay, event, and reset times in milliseconds. If the input value is outside the specified range, the SUSI API returns an error/failed message. The minimum value supported should be indicated when setting watchdog values. All watchdog values should be an integer multiple of the minimum value.

Time Setting Example

In the example provided in the above screenshot, the maximum delay time supported is 255000 milliseconds (ms), the minimum delay time is 0 ms, and the minimum value (minimum unit) is 1000 ms (1 second). Because every set value must be an integer multiple of 1000 milliseconds, 1500 milliseconds cannot be set as a time value.

■ Delay Time Setting

- Set the delay time to a value within the maximum/minimum delay time range. For information regarding setting values, please refer to the **Time Setting Information** subsection.

■ Reset Time Setting

- Set the reset time to a value within the maximum/minimum reset time range. For information regarding setting values, please refer to the **Time Setting Information** subsection.
- When the watchdog timer reaches the specified reset time, the board reset process will be initiated.

■ Event Type and Event Time Setting

- The Event Type options include “None”, “IRQ”, “SCI”, and “Power Button”. If the Event Type is set as IRQ, SCI, or Power Button, the Event Time will be configurable. If the Event Type is set as None, an Event Time value is not required.

-
- Set the event time to a value within the maximum/minimum event time range. For information regarding setting values, please refer to the **Time Setting Information** subsection.
 - When the watchdog timer reaches the specified event time, the selected event type will be triggered. If the Event Type is set as IRQ, a callback function will be initiated. In the demo program, the callback function prompts a text box with the message "Get IRQ Event" to be displayed onscreen.
 - Some boards do not support the Event Time function. In such cases, the Event Type and Event Time data fields are disabled.
- **Watchdog Timer Control**
- Start Timer: After configuring all settings, click the Start button to start the watchdog timer.
 - Trigger Timer: After the watchdog timer is initiated and the delay time is reached, click the Trigger button to reset/restart the timer.
 - Stop Timer: When the watchdog timer is activated, click the Stop button to stop the timer.

Appendix **A**

Pin Assignments

A.1 Jumper Settings

Table A.1: Jumper List

J1	LCD power / Auto power on
SW1	DDR3 / DDR3L power select
SW2	LAN Enable / Disable

A.2 Connectors

Table A.2: Connectors

CN1	12 V power input
CN2	DDR3 SODIMM
CN3	18-bit LVDS panel
CN5	HD audio
CN6	Inverter power / Internal SATA power
CN7	GPIO
CN8	DC jack (upon request)
CN10	mSATA
CN12	COM 1 / COM 2
CN14	Front panel
CN15	VGA
CN16	MIOe
CN17	Gigabit Ethernet
CN18	CPU fan
CN20	HDMI
CN21	SATA
CN22	SMBus
CN24	Internal USB
CN25	External USB
CN31	Mini PCIe
BH1	Battery

Table A.3: J1: LCD Power / Auto Power On

Part No.	1653003260
Footprint	HD_3x2P_79
Description	Pin header 3*2P 180D(M) 2.0 mm SMD square pin
Setting	Function
(1-2)	+5 V
(3-4) (default)	+3.3 V
(5-6) (default)	Auto power on

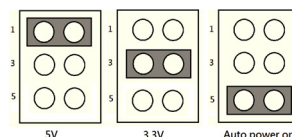

SW1	DDR3 / DDR3L Power Select
Part No.	160000071
Footprint	SW_3P_CJS-1201TA1
Description	DIP SW CJS-1201TA1 SMD 3P SPDT P = 6.0 mm W = 2.5 mm
Setting	Function
(1-2)	DDR3L
(2-3)*	DDR3

*default

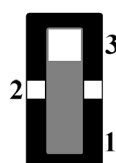
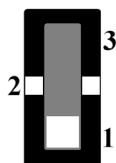

SW2	LAN Enable and Disable
Part No.	160000071
Footprint	SW_3P_CJS-1201TA1
Description	DIP SW CJS-1201TA1 SMD 3P SPDT P = 6.0 mm W = 2.5 mm
Setting	Function
(1-2)*	LAN enable
(2-3)	LAN disable

*default

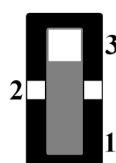
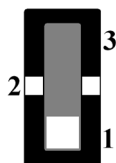

CN1	12 V Power Input
Part No.	1655003962
Footprint	WF_2P_156_D_A3963WV2
Description	
Pin	Pin Name
1	GND
2	+12V

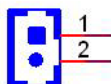

CN2	DDR3 SODIMM
Part No.	1651002083
Footprint	DDR3_204P_AS0A626-JA
Description	

CN3	18-bit LVDS Panel
Part No.	1655000753
Footprint	WF14P_49_BOX_RA_85204-14001
Description	
Pin	Pin Name
1	GND
2	GND
3	LVDS0_CLK-
4	LVDS0_CLK+
5	NC
6	NC
7	LVDS0_D2-
8	LVDS0_D2+
9	LVDS0_D1-
10	LVDS0_D1+
11	LVDS0_D0-
12	LVDS0_D0+
13	+5 V or +3.3 V
14	+5 V or +3.3 V

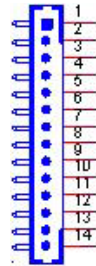

CN5	HD Audio
Part No.	1653003719
Footprint	HD_5x2P_79_RA_21N22050
Description	
Pin	Pin Name
1	LOUTR
2	LINR
3	GND
4	GND
5	LOUTL
6	LINL
7	NC
8	NC
9	NC
10	NC

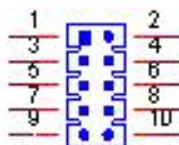

CN6	Inverter Power / Internal SATA Power
Part No.	1655905100
Footprint	WF_5P_49_BOX_RA
Description	Wafer 1.25 mm 5P 90D Male SMD 852040
Pin	Pin Name
1	+12 V
2	GND
3	ENABKL
4	VBR
5	+5 V

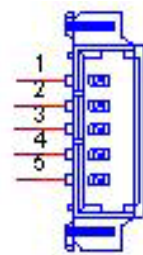

CN7	GPIO
Part No.	1653005261
Footprint	HD_5x2P_79
Description	Pin header SMD 5*2P 180D(M) 2.0 mm
Pin	Pin Name
1	+5 V
2	GPIO4
3	GPIO0
4	GPIO5
5	GPIO1
6	GPIO6
7	GPIO2
8	GPIO7
9	GPIO3
10	GND

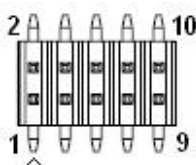

CN8	DC Jack (upon request)
Part No.	1652005684
Footprint	PJ_3P_DCJ-RPBT5NW-25
Description	
Pin	Pin Name
1	+VIN
2	GND

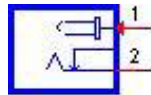

CN10	mSATA
Part No.	1654002538
Footprint	MINIPCIE_HALF_PICO_ITX
Description	
Pin	Pin Name
1	NC
2	+3.3 V
3	NC
4	GND
5	NC
6	+1.5 V
7	NC
8	NC
9	GND
10	NC
11	NC
12	NC
13	NC
14	NC
15	GND
16	NC
17	NC
18	GND
19	NC
20	NC
21	GND
22	NC
23	RX+
24	+3.3 V
25	RX-
26	GND

CN10	mSATA
Part No.	1654002538
Footprint	MINIPCIE_HALF_PICO_ITX
Description	
Pin	Pin Name
27	GND
28	+1.5 V
29	GND
30	SMB_CLK
31	TX-
32	SMB_DAT
33	TX+
34	GND
35	GND
36	USB P-
37	GND
38	USB P+
39	+3.3 V
40	GND
41	+3.3 V
42	NC
43	NC
44	NC
45	NC
46	NC
47	NC
48	+1.5 V
49	NC
50	GND
51	NC
52	+3.3 V

CN12	COM 1 / COM 2
Part No.	1653003720
Footprint	HD_10x2P_79_RA
Description	
Pin	Pin Name
1	DCD1#
2	DSR1#
3	RXD1
4	RTS1#
5	TXD1
6	CTS1#
7	DTR1#
8	RI1#
9	GND
10	GND
11	DCD2#
12	DSR2#
13	RXD2
14	RTS2#
15	TXD2
16	CTS2#
17	DTR2#
18	RI2#
19	GND
20	GND

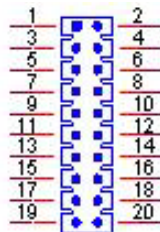

CN14	Front Panel
Part No.	1653004883
Footprint	HD_3x2P_79_RA_21N22050
Description	
Pin	Pin Name
1	Power button Pin 1
2	Power LED+
3	Power / Reset button Pin 2
4	HDD LED+
5	Reset button Pin 1
6	HDD LED

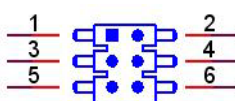

CN15	VGA
Part No.	1654000055
Footprint	DBVGA-VF5MS
Description	
D-SUB Conn. 15P 90D(F) DIP 070242FR015S200ZU	
Pin	Pin Name
1	RED
2	GREEN
3	BLUE
4	NC
5	GND
6	GND
7	GND
8	GND
9	NC
10	GND
11	NC
12	DDAT
13	HSYNC
14	VSYNC
15	DCLK

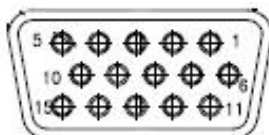

CN16	MIOe
Part No.	1654006235
Footprint	BB_40x2P_32_1625x285_2HOLD
Description	
Pin	Pin Name
1	GND
2	GND
3	PCIE_RX2+
4	PCIE_TX2+
5	PCIE_RX2-
6	PCIE_TX2-
7	GND
8	GND
9	PCIE_RX3+
10	PCIE_TX3+
11	PCIE_RX3-
12	PCIE_TX3-
13	GND
14	GND
15	NC
16	NC
17	NC
18	NC
19	GND
20	GND
21	NC
22	NC
23	NC
24	NC
25	GND
26	GND

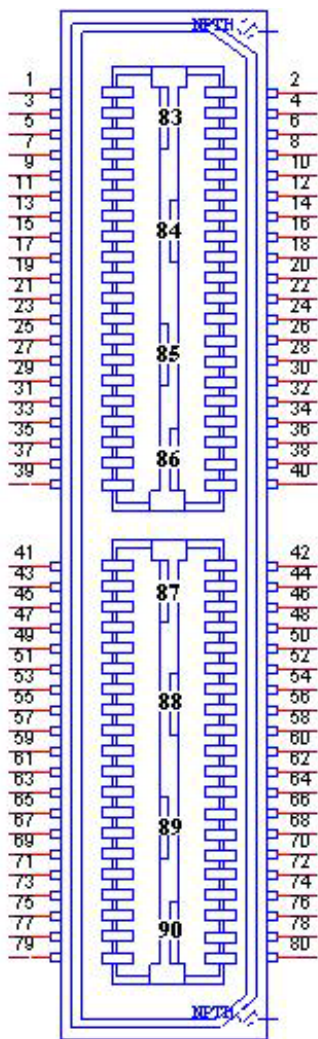

CN16	MIOe
Part No.	1654006235
Footprint	BB_40x2P_32_1625x285_2HOLD
Description	
Pin	Pin Name
27	PCIE_CLK+
28	LOUTL
29	PCIE_CLK-
30	LOUTR
31	GND
32	AGND
33	SMB_CLK
34	NC
35	SMB_DAT
36	NC
37	PCIE_WAKE#
38	NC
39	RESET#
40	NC
41	SLP_S3#
42	CLK33M
43	NC
44	LPC_AD0
45	DDP_HPD
46	LPC_AD1
47	GND
48	LPC_AD2
49	DDP_AUX+
50	LPC_AD3
51	DDP_AUX-
52	LPC_DRQ#0

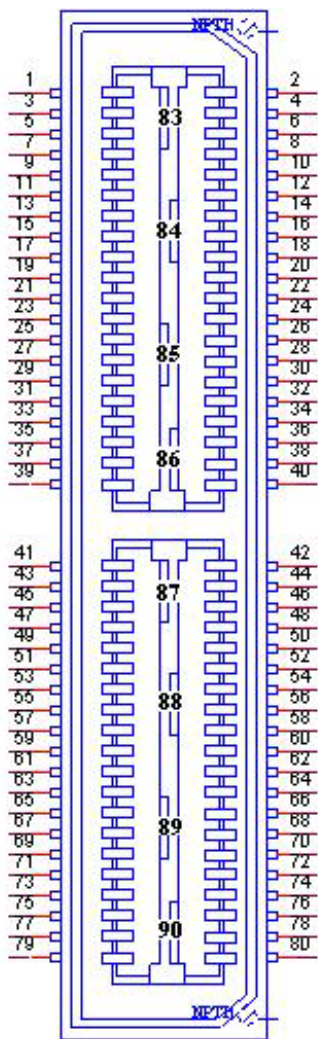

CN16	MIOe
Part No.	1654006235
Footprint	BB_40x2P_32_1625x285_2HOLD
Description	
Pin	Pin Name
53	GND
54	LPC_SERIRQ
55	DDP_D0+
56	LPC_FRAME#
57	DDP_D0-
58	GND
59	GND
60	USB0_P+
61	DDP_D1+
62	USB0_P-
63	DDP_D1-
64	GND
65	GND
66	USB1_P+
67	DDP_D2+
68	USB1_P-
69	DDP_D2-
70	GND
71	GND
72	NC
73	DDP_D3+
74	NC
75	DDP_D3-
76	GND
77	GND
78	USB_OC#

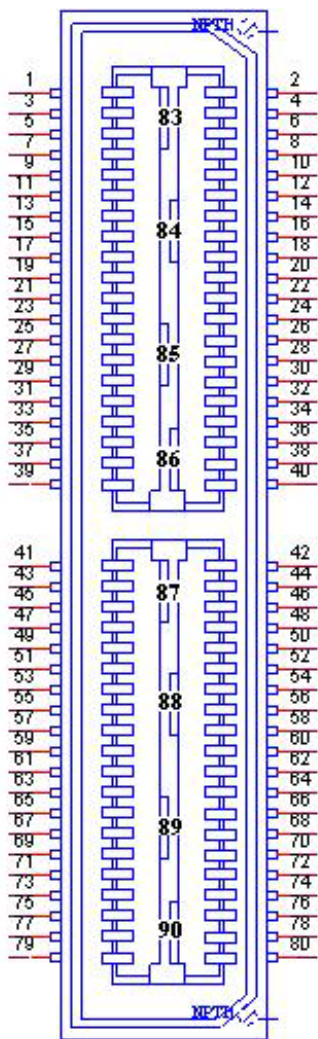

CN16	MIOe
Part No.	1654006235
Footprint	BB_40x2P_32_1625x285_2HOLD
Description	
Pin	Pin Name
79	+12VSB
80	+12VSB
83	GND
84	GND
85	GND
86	GND
87	+5VSB
88	+5VSB
89	+5VSB
90	+5VSB

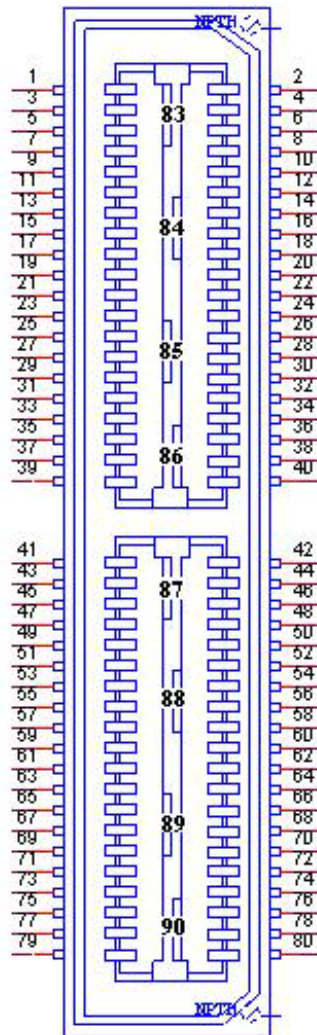

CN17	Gigabit Ethernet
Part No.	1652004356
Footprint	RJ45_14P_RT7-194AAM1A
Description	
Pin	Pin Name
1	BI_DA+(GHz)
2	BI_DA-(GHz)
3	BI_DB+(GHz)
4	BI_DC+(GHz)
5	BI_DC-(GHz)
6	BI_DB-(GHz)
7	BI_DD+(GHz)
8	BI_DD-(GHz)
H3	GND
H4	GND

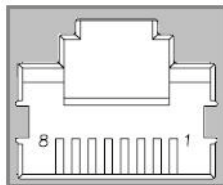

CN18	CPU FAN
Part No.	1655302020
Footprint	WF_2P_79_BOX_R1_D
Description	WAFER BOX 2P 2.0 mm 180D(M) DIP A2001WV2-2P
Pin	Pin Name
1	+12 V
2	GND

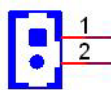

CN20	HDMI_19H
Part No.	1654011175-01
Footprint	HDMI_19P_QJ51191-LFB4-7F
Description	

CN21	SATA
Part No.	1654007578
Footprint	SATA_7P_WATF-07DBN6SB1U
Description	
Pin	Pin Name
1	GND
2	TX+
3	TX-
4	GND
5	RX-
6	RX+
7	GND

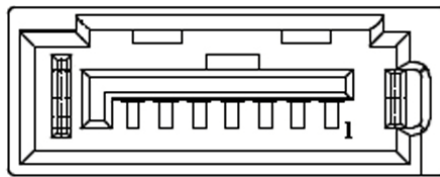

CN22	SMBus
Part No.	1655904020
Footprint	FPC4V-125M
Description	Wafer SMT 1.25 mm S/T type 4P 180D(M) 85205-04001
Pin	Pin Name
1	GND
2	SMB_DAT
3	SMB_CLK
4	+5 V

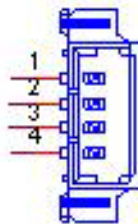

CN24	Internal USB
Part No.	1653005260
Footprint	HD_5x2P_79_N10
Description	Pin header 2*5P 180D(M) 2.0 mm SMD idiot-proof
Pin	Pin Name
1	+5 V
2	+5 V
3	A_D-
4	B_D-
5	A_D+
6	B_D+
7	GND
8	GND
9	GND

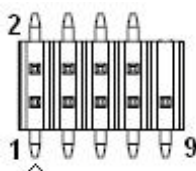

CN25	External USB2.0+USB3.0
Part No.	1654009860
Footprint	USB_9x2P_2360009-603-R
Description	
Pin	Pin Name
1	+5 V
2	D-
3	D+
4	GND
5	SSRX-
6	SSRX+
7	GND
8	SSTX-
9	SSTX+

CN31	Mini PCIe
Part No.	1654002538
Footprint	MINIPCIE_HALF_PICO2600
Description	
Pin	Pin Name
1	WAKE#
2	+3.3VSB
3	NC
4	GND
5	NC
6	+1.5 V
7	NC
8	NC
9	GND
10	NC
11	REFCLK-
12	NC
13	REFCLK+
14	NC
15	GND
16	NC
17	NC
18	GND
19	NC
20	NC
21	GND
22	PERST#
23	PERn0
24	+3.3VSB
25	PERp0
26	GND

CN31	Mini PCIE
Part No.	1654002538
Footprint	MINIPCIE_HALF_PICO2600
Description	
Pin	Pin Name
27	GND
28	+1.5 V
29	GND
30	SMB_CLK
31	PETn0
32	SMB_DAT
33	PETp0
34	GND
35	GND
36	USB D-
37	GND
38	USB D+
39	+3.3 VSB
40	GND
41	+3.3 VSB
42	NC
43	GND
44	NC
45	NC
46	NC
47	NC
48	+1.5 V
49	NC
50	GND
51	NC
52	+3.3 VSB

Appendix **B**

WDT and GPIO

B.1 Watchdog Timer Sample Code

Watchdog Function

The SCH3114 runtime base I/O address is 680h.

Set the Watchdog time value to offset at 66h.

If the set value is "0", the Watchdog function is disabled.

```
Superio_GPIO_Port = 680h
```

```
mov dx,Superio_GPIO_Port + 66h
```

```
mov al,00h
```

```
out dx,al
```

```
.model small
```

```
.486p
```

```
.stack 256
```

```
.data
```

```
SCH3114_IO EQU 680h
```

```
.code
```

```
org 100h
```

```
.STARTup
```

```
;=====
```

```
;47H
```

```
;enable WDT function bit [0]=0Ch
```

```
;=====
```

```
mov dx,SCH3114_IO + 47h
```

```
mov al,0Ch
```

```
out dx,al
```

```
;=====
```

```
;65H
```

```
;bit [1:0]=Reserved
```

```
;bit [6:2]Reserve=00000
```

```
;bit [7] WDT time-out Value Units Select
```

```
;Minutes=0 (default) Seconds=1
```

```
;=====
```

```
mov dx,SCH3114_IO + 65h ;
```

```
mov al,080h
```

```
out dx,al
```

```
;=====
```

```
;66H
```

```
;WDT timer time-out value
```

```
;bit[7:0]=0~255
```

```
;=====
```

```
mov dx,SCH3114_IO + 66h
```

```
mov al,01h
```

```
out dx,al
```

```
;=====
```

```
;bit[0] status bit R/W
```

```
;WD timeout occurred =1
```

```

;WD timer counting = 0
;=====
mov dx,SCH3114_IO + 68h
mov al,01h
out dx,al
.exit
END

```

B.2 GPIO Sample Code

The SCH3114 runtime base I/O address is 680h.

```

.model small
.486p
.stack 256
.data
SCH3114_IO EQU 680h
.code
org 100h
.STARTup
;=====
; Configure the GPIO as GPI or GPO using the register below
; GPIO0 = 23H, GPIO4 = 27H
; GPIO1 = 24H, GPIO5 = 29H
; GPIO2 = 25H, GPIO6 = 2AH
; GPIO3 = 26H, GPIO7 = 2BH
; Set 00H as output type, set 01H as input type
;=====
;=====
; Register the 4BH configuration GPO value as high or low
; 1 = HIGH
; 0 = LOW
;=====

mov dx,SCH3114_IO + 23h      ;GPIO 0
mov al,00h                  ;Set GPIO 0 as output type
out dx,al

mov dx,SCH3114_IO + 4Bh
mov al,01h                  ;Set GPIO 0 as high value.
out dx,al

.exit
END

```

Appendix **C**

System Assignments

C.1 System I/O Ports

Table C.1: System I/O Ports

Addr. Range (Hex)	Device
000-02F	DMA controller
020-02D	Interrupt controller
040-04F	System resource
050-052	Timer / Counter
060-06F	8042 (keyboard controller)
070-07F	Real-time clock, non-maskable interrupt (NMI) mask
080-09F	DMA page register
0A0-0FF	System resource
0C0-0DF	DMA controller
0F0-0FF	System resource
12E-12F	System resource
2F8-2FF	Serial Port 2
3C0-3DF	System resource
3F8-3FF	Serial Port 1
400-4FF	System resource
500-5FF	System resource
680-6FF	System resource
800-8FF	System resource
B00-B3F	System resource
C00-CFF	System resource

C.2 First MB Memory Map

Table C.2: First MB Memory Map

Addr. Range (Hex)	Device
F0000h - FFFFFh	System ROM
D0000h - E7FFFh	Unused (reserved for Ethernet ROM)
C0000h - CFFFFh	Expansion ROM (for VGA BIOS)
B8000h - BFFFFh	CGA/EGA/VGA text
A0000h - B7FFFh	EGA/VGA graphics
00000h - 9FFFFh	Base memory

C.3 Interrupt Assignments

Table C.3: Interrupt Assignments

Interrupt#	Interrupt Source
IRQ0	Interval timer
IRQ1	Keyboard
IRQ2	Interrupt from controller 2 (cascade)
IRQ3	COM 2
IRQ4	COM 1
IRQ5	Available
IRQ6	Available
IRQ7	Available
IRQ8	RTC
IRQ9	Reserved
IRQ10	Available
IRQ11	Available
IRQ12	Reserved
IRQ13	Math coprocessor
IRQ14	Reserved
IRQ15	Reserved

ADVANTECH

Enabling an Intelligent Planet

www.advantech.com

Please verify specifications before quoting. This guide is intended for reference purposes only.

All product specifications are subject to change without notice.

No part of this publication may be reproduced in any form or by any means, electronic, photocopying, recording or otherwise, without prior written permission from the publisher.

All brand and product names are trademarks or registered trademarks of their respective companies.

© Advantech Co., Ltd. 2014