

SD2410

Silicon Photodarlington

FEATURES

- Miniature, hermetically sealed, pill style, metal can package
- 48° (nominal) acceptance angle
- Wide operating temperature range (- 55°C to +125°C)
- Ideal for direct mounting to printed circuit boards
- Wide sensitivity ranges
- Mechanically and spectrally matched to SE2460 and SE2470 infrared emitting diodes

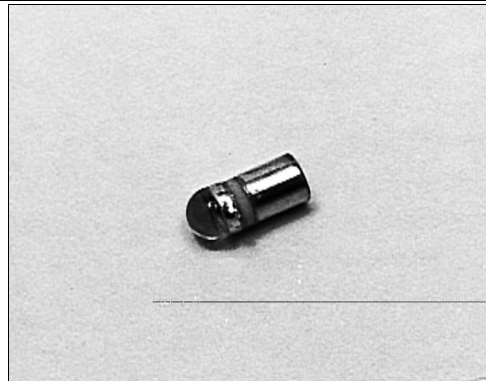

INFRA-1.TIF

DESCRIPTION

The SD2410 is an NPN silicon photodarlington mounted in a hermetically sealed glass lensed metal can package. This package directly mounts in double sided PC boards.

OUTLINE DIMENSIONS in inches (mm)

Tolerance 3 plc decimals ±0.005(0.12)
2 plc decimals ±0.020(0.51)

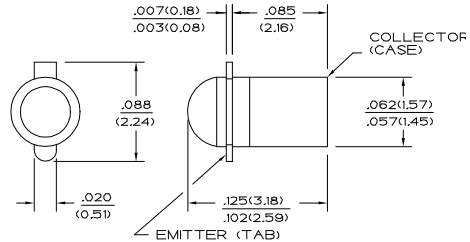

DIM_013.cdr

SD2410

Silicon Photodarlington

ELECTRICAL CHARACTERISTICS (25°C unless otherwise noted)

PARAMETER	SYMBOL	MIN	TYP	MAX	UNITS	TEST CONDITIONS
Light Current SD2410-001 SD2410-002 SD2410-003	I_L	1.0 3.0 6.0			mA	$V_{CE}=5\text{ V}$ $H=1\text{ mW/cm}^2$ (1)
Collector Dark Current	I_{CEO}			250	nA	$V_{CE}=10\text{ V}$, $H=0$
Collector-Emitter Breakdown Voltage	$V_{(BR)CEO}$	15			V	$I_C=100\text{ }\mu\text{A}$
Emitter-Collector Breakdown Voltage	$V_{(BR)ECO}$	5.0			V	$I_E=100\text{ }\mu\text{A}$
Collector-Emitter Saturation Voltage	$V_{CE(SAT)}$			1.1	V	$I_C=1\text{ mA}$ $H=5\text{ mW/cm}^2$
Angular Response (2)	\emptyset		48		degr.	$I_F=\text{Constant}$
Rise And Fall Time	t_r, t_f		75		μs	$V_{CC}=5\text{ V}$, $I_L=1\text{ mA}$ $R_L=100\text{ }\Omega$

Notes

1. The radiation source is a tungsten lamp operating at a color temperature of 2870°K.
2. Angular response is defined as the total included angle between the half sensitivity points.

ABSOLUTE MAXIMUM RATINGS

(25°C Free-Air Temperature unless otherwise noted)

Collector-Emitter Voltage	15 V
Emitter-Collector Voltage	5 V
Power Dissipation	125 mW (1)
Operating Temperature Range	-55°C to 125°C
Storage Temperature Range	-65°C to 150°C
Soldering Temperature (10 sec)	260°C

Notes

1. Derate linearly from 25°C free-air temperature at the rate of 1.19 mW/°C.

SCHEMATIC

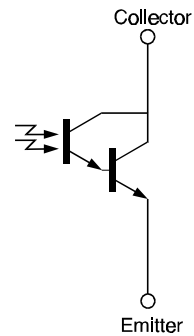

Honeywell reserves the right to make changes in order to improve design and supply the best products possible.

Honeywell

SD2410

Silicon Photodarlington

SWITCHING TIME TEST CIRCUIT

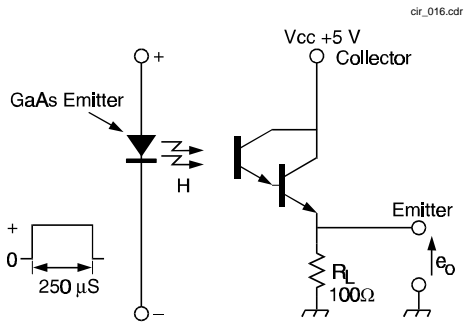

SWITCHING WAVEFORM

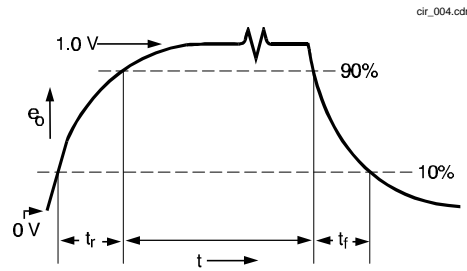

Fig. 1 Responsivity vs Angular Displacement

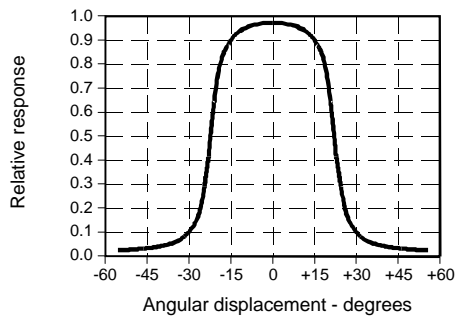

Fig. 2 Non-Saturated Switching Time vs Load Resistance

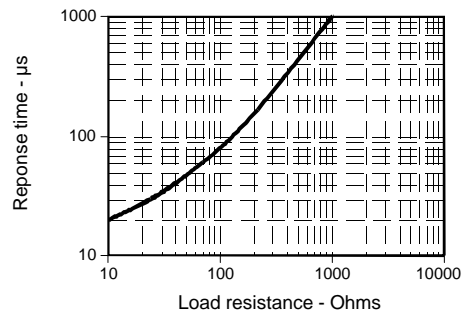
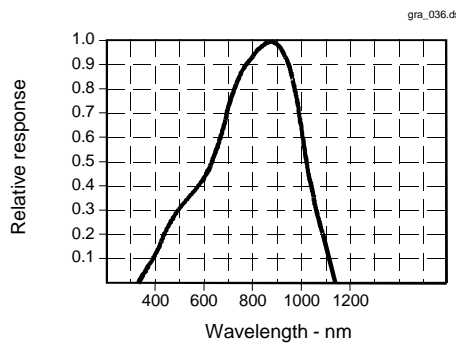

Fig. 3 Spectral Responsivity



All Performance Curves Show Typical Values

SD2410
Silicon Photodarlington



Honeywell reserves the right to make changes in order to improve design and supply the best products possible.

Honeywell