



FEATURES

- AD5307:** 4 buffered 8-bit DACs in 16-lead TSSOP
A version: ± 1 LSB INL; B version: ± 0.625 LSB INL
- AD5317:** 4 buffered 10-bit DACs in 16-lead TSSOP
A version: ± 4 LSB INL; B version: ± 2.5 LSB INL
- AD5327:** 4 buffered 12-bit DACs in 16-lead TSSOP
A version: ± 16 LSB INL; B version: ± 10 LSB INL
- Low power operation: 400 μ A @ 3 V, 500 μ A @ 5 V
- 2.5 V to 5.5 V power supply
- Guaranteed monotonic by design over all codes
- Power down to 90 nA @ 3 V, 300 nA @ 5 V ($\overline{\text{LDAC}}$ pin)
- Double-buffered input logic
- Buffered/unbuffered reference input options
- Output range: 0 V to V_{REF} or 0 V to $2 V_{\text{REF}}$
- Power-on reset to 0 V
- Simultaneous update of outputs ($\overline{\text{LDAC}}$ pin)
- Asynchronous clear facility ($\overline{\text{CLR}}$ pin)
- Low power, SPI[®]-, QSPI[™]-, MICROWIRE[™]-, and DSP-compatible 3-wire serial interface
- SDO daisy-chaining option
- On-chip rail-to-rail output buffer amplifiers
- Temperature range of -40°C to $+105^{\circ}\text{C}$

APPLICATIONS

- Portable battery-powered instruments
- Digital gain and offset adjustment
- Programmable voltage and current sources
- Programmable attenuators
- Industrial process control

GENERAL DESCRIPTION

The AD5307/AD5317/AD5327¹ are quad 8-,10-,12-bit buffered voltage-output DACs in 16-lead TSSOP that operate from single 2.5 V to 5.5 V supplies and consume 400 μ A at 3 V. Their on-chip output amplifiers allow the outputs to swing rail-to-rail with a slew rate of 0.7 V/ μ s. The AD5307/AD5317/AD5327 utilize versatile 3-wire serial interfaces that operate at clock rates up to 30 MHz; these parts are compatible with standard SPI, QSPI, MICROWIRE, and DSP interface standards.

The references for the four DACs are derived from two reference pins (one per DAC pair). These reference inputs can be configured as buffered or unbuffered inputs. Each part incorporates a power-on reset circuit, ensuring that the DAC outputs power up to 0 V and remain there until a valid write to the device takes place. There is also an asynchronous active low $\overline{\text{CLR}}$ pin that clears all DACs to 0 V. The outputs of all DACs can be updated simultaneously using the asynchronous $\overline{\text{LDAC}}$ input. Each part contains a power-down feature that reduces the current consumption of the device to 300 nA @ 5 V (90 nA @ 3 V). The parts can also be used in daisy-chaining applications using the SDO pin.

All three parts are offered in the same pinout, allowing users to select the amount of resolution appropriate for their application without redesigning their circuit board.

FUNCTIONAL BLOCK DIAGRAM



Figure 1.

¹ Patents pending.

Rev. D

Document Feedback

Information furnished by Analog Devices is believed to be accurate and reliable. However, no responsibility is assumed by Analog Devices for its use, nor for any infringements of patents or other rights of third parties that may result from its use. Specifications subject to change without notice. No license is granted by implication or otherwise under any patent or patent rights of Analog Devices. Trademarks and registered trademarks are the property of their respective owners.

TABLE OF CONTENTS

Features	1	Input Shift Register	17
Applications.....	1	Control Bits	17
General Description	1	Low Power Serial Interface	18
Functional Block Diagram	1	Daisy Chaining	18
Revision History	2	Double-Buffered Interface	18
Specifications.....	3	Load DAC Input ($\overline{\text{LDAC}}$).....	18
AC Characteristics.....	5	Power-Down Mode.....	18
Timing Characteristics	5	Microprocessor Interfacing.....	19
Absolute Maximum Ratings.....	7	Applications.....	20
ESD Caution.....	7	Typical Application Circuit.....	20
Pin Configuration and Function Descriptions.....	8	Driving V_{DD} from the Reference Voltage	20
Typical Performance Characteristics	9	Bipolar Operation.....	20
Terminology	13	Opto-Isolated Interface for Process-Control Applications... 21	
Transfer Function	14	Decoding Multiple AD5307/AD5317/AD5327 Devices..... 21	
Functional Description	15	AD5307/AD5317/AD5327 as Digitally Programmable	
Digital-to-Analog Section	15	Window Detectors	21
Resistor String.....	15	Daisy Chaining	22
DAC Reference Inputs	15	Power Supply Bypassing and Grounding.....	22
Output Amplifier.....	16	Outline Dimensions	24
Power-On Reset	16	Ordering Guide	25
Serial Interface	17		

REVISION HISTORY

12/2016—Rev. C to Rev. D

Change to Input Current Parameter, Table 1	4
Change to Table 7	23
Changes to Ordering Guide	25

3/2006—Rev. B to Rev. C

Changes to Table 3.....	5
Changes to Ordering Guide	25

10/2005—Rev. A to Rev. B

Updated Format.....	Universal
Changes to Bipolar Operation Section	21
Changes to Ordering Guide	25

8/2003—Rev. 0 to Rev. A

Added A Version	Universal
Changes to Features	1
Changes to Specifications.....	2
Changes to Absolute Maximum Ratings.....	6
Changes to Ordering Guide	6
Changes to TPC 21.....	12
Added Octals section to Table II	20
Updated Outline Dimensions	21

SPECIFICATIONS

$V_{DD} = 2.5 \text{ V to } 5.5 \text{ V}$, $V_{REF} = 2 \text{ V}$, $R_L = 2 \text{ k}\Omega$ to GND, $C_L = 200 \text{ pF}$ to GND. All specifications T_{MIN} to T_{MAX} , unless otherwise noted.

Table 1.

Parameter ²	A Version ¹			B Version ¹			Unit	Conditions/Comments	
	Min	Typ	Max	Min	Typ	Max			
DC PERFORMANCE ^{3, 4}									
AD5307									
Resolution		8		8			Bits	Guaranteed monotonic by design over all codes	
Relative Accuracy		± 0.15	± 1	± 0.15	± 0.625		LSB		
Differential Nonlinearity		± 0.02	± 0.25	± 0.02	± 0.25		LSB		
AD5317									
Resolution		10		10			Bits		
Relative Accuracy		± 0.5	± 4	± 0.5	± 2.5		LSB		
Differential Nonlinearity		± 0.05	± 0.5	± 0.05	± 0.5		LSB		
AD5327									
Resolution		12		12			Bits	Guaranteed monotonic by design over all codes	
Relative Accuracy		± 2	± 16	± 2	± 10		LSB		
Differential Nonlinearity		± 0.2	± 1	± 0.2	± 1		LSB		
Offset Error		± 5	± 60	± 5	± 60		mV		
Gain Error		± 0.3	± 1.25	± 0.3	± 1.25		% FSR		
Lower Dead Band ⁵		10	60	10	60		mV		
Upper Dead Band ⁵		10	60	10	60		mV		
Offset Error Drift ⁶		-12		-12			ppm of FSR/ $^{\circ}\text{C}$	$\Delta V_{DD} = \pm 10\%$ $R_L = 2 \text{ k}\Omega$ to GND or V_{DD}	
Gain Error Drift ⁶		-5		-5			ppm of FSR/ $^{\circ}\text{C}$		
DC Power Supply Rejection Ratio ⁶		-60		-60			dB		
DC Crosstalk ⁶		200		200			mV		
DAC REFERENCE INPUTS ⁶									
V_{REF} Input Range	1		V_{DD}	1		V_{DD}	V		Buffered reference mode
	0.25		V_{DD}	0.25		V_{DD}	V	Unbuffered reference mode	
V_{REF} Input Impedance (R_{DAC})		>10			>10		M Ω	Buffered reference mode and power-down mode	
	74	90		74	90		k Ω	Unbuffered reference mode, 0 V to V_{REF} output range	
	37	45		37	45		k Ω	Unbuffered reference mode, 0 V to $2 V_{REF}$ output range	
Reference Feedthrough		-90		-90			dB	Frequency = 10 kHz	
Channel-to-Channel Isolation		-75		-75			dB	Frequency = 10 kHz	
OUTPUT CHARACTERISTICS ⁶									
Minimum Output Voltage ⁷		0.001		0.001			V	A measure of the minimum drive capability of the output amplifier	
Maximum Output Voltage ⁷		$V_{DD} - 0.001$		$V_{DD} - 0.001$			V	A measure of the maximum drive capability of the output amplifier	
DC Output Impedance		0.5		0.5			Ω		
Short-Circuit Current		25		25			mA	$V_{DD} = 5 \text{ V}$	
		16		16			mA	$V_{DD} = 3 \text{ V}$	
Power-Up Time		2.5		2.5			μs	Coming out of power-down mode, $V_{DD} = 5 \text{ V}$	
		5		5			μs	Coming out of power-down mode, $V_{DD} = 3 \text{ V}$	

Parameter ²	A Version ¹			B Version ¹			Unit	Conditions/Comments
	Min	Typ	Max	Min	Typ	Max		
LOGIC INPUTS ⁶								
Input Current			±1			±1	μA	
Input Low Voltage, V _{IL}			0.8			0.8	V	V _{DD} = 5 V ± 10%
			0.6			0.6	V	V _{DD} = 3 V ± 10%
			0.5			0.5	V	V _{DD} = 2.5 V
Input High Voltage, V _{IH} (Excluding DCEN)	1.7			1.7			V	V _{DD} = 2.5 V to 5.5 V; TTL and 1.8 V CMOS compatible
Input High Voltage, V _{IH} (DCEN)	2.4			2.4				V _{DD} = 5 V ± 10%
	2.1			2.1			V	V _{DD} = 3 V ± 10%
	2.0			2.0			V	V _{DD} = 2.5 V
Pin Capacitance		3			3		pF	
LOGIC OUTPUT (SDO) ⁶								
V _{DD} = 4.5 V to 5.5 V								
Output Low Voltage, V _{OL}		0.4				0.4	V	I _{SINK} = 2 mA
Output High Voltage, V _{OH} V _{DD} = 2.5 V to 3.6 V	V _{DD} - 1			V _{DD} - 1			V	I _{SOURCE} = 2 mA
Output Low Voltage, V _{OL}		0.4		0.4			V	I _{SINK} = 2 mA
Output High Voltage, V _{OH}	V _{DD} - 0.5			V _{DD} - 0.5			V	I _{SOURCE} = 2 mA
Floating State Leakage Current			±1			±1	μA	DCEN = GND
Floating State Output Capacitance		3			3		pF	DCEN = GND
POWER REQUIREMENTS								
V _{DD}	2.5		5.5	2.5		5.5	V	
I _{DD} (Normal Mode) ⁸								
V _{DD} = 4.5 V to 5.5 V		500	900		500	900	μA	V _{IH} = V _{DD} and V _{IL} = GND
V _{DD} = 2.5 V to 3.6 V		400	750		400	750	μA	All DACs in unbuffered mode; in buffered mode, extra current is typically x mA per DAC, where x = 5 mA + V _{REF} /R _{DAC}
I _{DD} (Power-Down Mode)								V _{IH} = V _{DD} and V _{IL} = GND
V _{DD} = 4.5 V to 5.5 V		0.3	1		0.3	1	μA	
V _{DD} = 2.5 V to 3.6 V		0.09	1		0.09	1	μA	

¹ Temperature range (A, B versions): -40°C to +105°C; typical at +25°C.

² See the Terminology section.

³ DC specifications tested with the outputs unloaded, unless otherwise noted.

⁴ Linearity is tested using a reduced code range: AD5307 (Code 8 to Code 255); AD5317 (Code 28 to Code 1023); AD5327 (Code 115 to Code 4095).

⁵ This corresponds to x codes, where x = deadband voltage/LSB size.

⁶ Guaranteed by design and characterization; not production tested.

⁷ For the amplifier output to reach its minimum voltage, offset error must be negative. For the amplifier output to reach its maximum voltage, V_{REF} = V_{DD} and offset plus gain error must be positive.

⁸ Interface inactive. All DACs active. DAC outputs unloaded.

AC CHARACTERISTICS

$V_{DD} = 2.5\text{ V to }5.5\text{ V}$, $R_L = 2\text{ k}\Omega$ to GND, $C_L = 200\text{ pF}$ to GND. All specifications T_{MIN} to T_{MAX} , unless otherwise noted.

Table 2.

Parameter ^{2, 3}	A, B Versions ¹			Unit	Conditions/Comments
	Min	Typ	Max		
Output Voltage Settling Time					$V_{REF} = V_{DD} = 5\text{ V}$
AD5307		6	8	μs	1/4 scale to 3/4 scale change (0x40 to 0xC0)
AD5317		7	9	μs	1/4 scale to 3/4 scale change (0x100 to 0x300)
AD5327		8	10	μs	1/4 scale to 3/4 scale change (0x400 to 0xC00)
Slew Rate		0.7		V/ μs	
Major-Code Change Glitch Energy		12		nV-s	1 LSB change around major carry
Digital Feedthrough		0.5		nV-s	
SDO Feedthrough		4		nV-s	Daisy-chain mode; SDO load is 10 pF
Digital Crosstalk		0.5		nV-s	
Analog Crosstalk		1		nV-s	
DAC-to-DAC Crosstalk		3		nV-s	
Multiplying Bandwidth		200		kHz	$V_{REF} = 2\text{ V} \pm 0.1\text{ V p-p}$; unbuffered mode
Total Harmonic Distortion		-70		dB	$V_{REF} = 2.5\text{ V} \pm 0.1\text{ V p-p}$; frequency = 10 kHz

¹ Temperature range (A, B versions): -40°C to $+105^\circ\text{C}$; typical at $+25^\circ\text{C}$.

² Guaranteed by design and characterization; not production tested.

³ See the Terminology section.

TIMING CHARACTERISTICS

$V_{DD} = 2.5\text{ V to }5.5\text{ V}$; all specifications T_{MIN} to T_{MAX} , unless otherwise noted.

Table 3.

Parameter ^{1, 2, 3}	A, B Versions Limit at T_{MIN} , T_{MAX}	Unit	Conditions/Comments
t_1	33	ns min	SCLK cycle time
t_2	13	ns min	SCLK high time
t_3	13	ns min	SCLK low time
t_4	13	ns min	$\overline{\text{SYNC}}$ to SCLK falling edge set-up time
t_5	5	ns min	Data set-up time
t_6	4.5	ns min	Data hold time
t_7	5	ns min	SCLK falling edge to $\overline{\text{SYNC}}$ rising edge
t_8	50	ns min	Minimum $\overline{\text{SYNC}}$ high time
t_9	20	ns min	$\overline{\text{LDAC}}$ pulse width
t_{10}	20	ns min	SCLK falling edge to $\overline{\text{LDAC}}$ rising edge
t_{11}	20	ns min	$\overline{\text{CLR}}$ pulse width
t_{12}	0	ns min	SCLK falling edge to $\overline{\text{LDAC}}$ falling edge
$t_{13}^{4, 5}$	20	ns max	SCLK rising edge to SDO valid ($V_{DD} = 3.6\text{ V to }5.5\text{ V}$)
	25	ns max	SCLK rising edge to SDO valid ($V_{DD} = 2.5\text{ V to }3.5\text{ V}$)
t_{14}^5	5	ns min	SCLK falling edge to $\overline{\text{SYNC}}$ rising edge
t_{15}^5	8	ns min	$\overline{\text{SYNC}}$ rising edge to SCLK rising edge
t_{16}^5	0	ns min	$\overline{\text{SYNC}}$ rising edge to $\overline{\text{LDAC}}$ falling edge

¹ Guaranteed by design and characterization; not production tested.

² All input signals are specified with $t_r = t_f = 5\text{ ns}$ (10% to 90% of V_{DD}) and timed from a voltage level of $(V_{IL} + V_{IH})/2$.

³ See Figure 3 and Figure 4.

⁴ This is measured with the load circuit of Figure 2. t_{13} determines maximum SCLK frequency in daisy-chain mode.

⁵ Daisy-chain mode only.



Figure 2. Load Circuit for Digital Output (SDO) Timing Specifications



NOTES
 1ASYNCHRONOUS LDAC UPDATE MODE.
 2SYNCHRONOUS LDAC UPDATE MODE.

Figure 3. Serial Interface Timing Diagram



Figure 4. Daisy-Chaining Timing Diagram

ABSOLUTE MAXIMUM RATINGS

$T_A = 25^\circ\text{C}$, unless otherwise noted.

Table 4.

Parameter ¹	Ratings
V_{DD} to GND	-0.3 V to +7 V
Digital Input Voltage to GND	-0.3 V to $V_{DD} + 0.3$ V
Digital Output Voltage to GND	-0.3 V to $V_{DD} + 0.3$ V
Reference Input Voltage to GND	-0.3 V to $V_{DD} + 0.3$ V
$V_{OUTA} - V_{OUTD}$ to GND	-0.3 V to $V_{DD} + 0.3$ V
Operating Temperature Range	
Industrial (A, B Versions)	-40°C to +105°C
Storage Temperature Range	-65°C to +150°C
Junction Temperature (T_J max)	150°C
16-Lead TSSOP	
Power Dissipation	$(T_J \text{ max} - T_A)/\theta_{JA}$
θ_{JA} Thermal Impedance	150.4°C/W
Reflow Soldering	
Peak Temperature	220°C
Time at Peak Temperature	10 sec to 40 sec

¹ Transient currents of up to 100 mA do not cause SCR latch-up.

Stresses above those listed under Absolute Maximum Ratings may cause permanent damage to the device. This is a stress rating only; functional operation of the device at these or any other conditions above those indicated in the operational section of this specification is not implied. Exposure to absolute maximum rating conditions for extended periods may affect device reliability.

ESD CAUTION

ESD (electrostatic discharge) sensitive device. Electrostatic charges as high as 4000 V readily accumulate on the human body and test equipment and can discharge without detection. Although this product features proprietary ESD protection circuitry, permanent damage may occur on devices subjected to high energy electrostatic discharges. Therefore, proper ESD precautions are recommended to avoid performance degradation or loss of functionality.



PIN CONFIGURATION AND FUNCTION DESCRIPTIONS

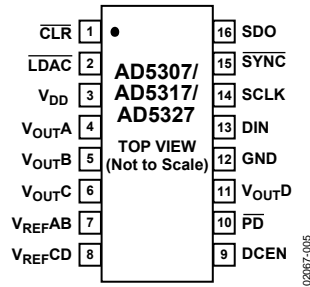

Figure 5. Pin Configuration

Table 5. Pin Function Descriptions

Pin No.	Mnemonic	Description
1	CLR	Active Low Control Input. Loads all 0s to all input and DAC registers. Therefore, the outputs also go to 0 V.
2	$\overline{\text{LDAC}}$	Active Low Control Input. Transfers the contents of the input registers to their respective DAC registers. Pulsing this pin low allows any or all DAC registers to be updated if the input registers have new data. This allows simultaneous update of all DAC outputs. Alternatively, this pin can be tied permanently low.
3	V _{DD}	Power Supply Input. These parts can be operated from 2.5 V to 5.5 V, and the supply should be decoupled with a 10 μF capacitor in parallel with a 0.1 μF capacitor to GND.
4	V _{OUTA}	Buffered Analog Output Voltage from DAC A. The output amplifier has rail-to-rail operation.
5	V _{OUTB}	Buffered Analog Output Voltage from DAC B. The output amplifier has rail-to-rail operation.
6	V _{OUTC}	Buffered Analog Output Voltage from DAC C. The output amplifier has rail-to-rail operation.
7	V _{REFAB}	Reference Input Pin for DAC A and DAC B. It can be configured as a buffered or unbuffered input to each or both of the DACs, depending on the state of the BUF bits in the serial input words to DAC A and DAC B. It has an input range of 0.25 V to V _{DD} in unbuffered mode and 1 V to V _{DD} in buffered mode.
8	V _{REFCD}	Reference Input Pin for DAC C and DAC D. It can be configured as a buffered or unbuffered input to each or both of the DACs, depending on the state of the BUF bits in the serial input words to DAC C and DAC D. It has an input range of 0.25 V to V _{DD} in unbuffered mode and 1 V to V _{DD} in buffered mode.
9	DCEN	Enables the Daisy-Chaining Option. It should be tied high if the part is being used in a daisy chain, and tied low if it is being used in standalone mode.
10	$\overline{\text{PD}}$	Active Low Control Input. It acts like a hardware power-down option. All DACs go into power-down mode when this pin is tied low. The DAC outputs go into a high impedance state, and the current consumption of the part drops to 300 nA @ 5 V (90 nA @ 3 V).
11	V _{OUTD}	Buffered Analog Output Voltage from DAC D. The output amplifier has rail-to-rail operation.
12	GND	Ground Reference Point for All Circuitry on the Part.
13	DIN	Serial Data Input. These devices each have a 16-bit shift register. Data is clocked into the register on the falling edge of the serial clock input. The DIN input buffer is powered down after each write cycle.
14	SCLK	Serial Clock Input. Data is clocked into the input shift register on the falling edge of the serial clock input. Data can be transferred at rates of up to 30 MHz. The SCLK input buffer is powered down after each write cycle.
15	$\overline{\text{SYNC}}$	Active Low Control Input. This is the frame synchronization signal for the input data. When $\overline{\text{SYNC}}$ goes low, it powers on the SCLK and DIN buffers and enables the input shift register. Data is transferred in on the falling edges of the following 16 clocks. If $\overline{\text{SYNC}}$ is taken high before the 16th falling edge, the rising edge of $\overline{\text{SYNC}}$ acts as an interrupt and the write sequence is ignored by the device.
16	SDO	Serial Data Output. Can be used for daisy-chaining a number of these devices together or for reading back the data in the shift register for diagnostic purposes. The serial data is transferred on the rising edge of SCLK and is valid on the falling edge of the clock.

TYPICAL PERFORMANCE CHARACTERISTICS



Figure 6. AD5307 INL

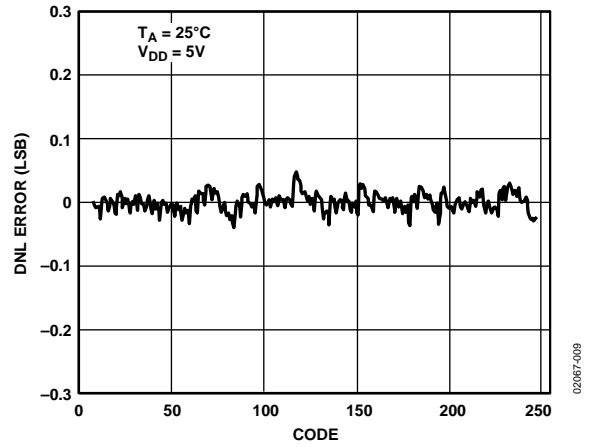

Figure 9. AD5307 DNL



Figure 7. AD5317 INL

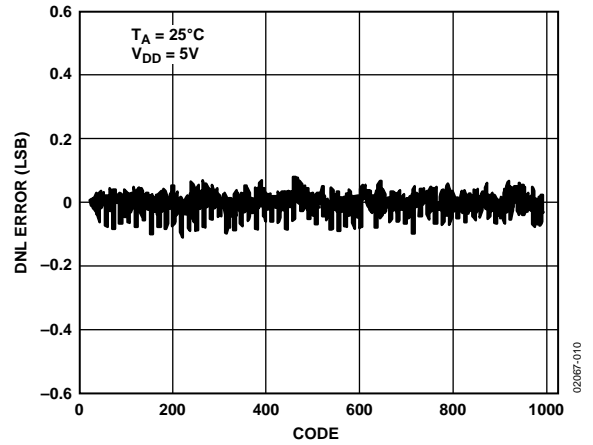

Figure 10. AD5317 DNL



Figure 8. AD5327 INL

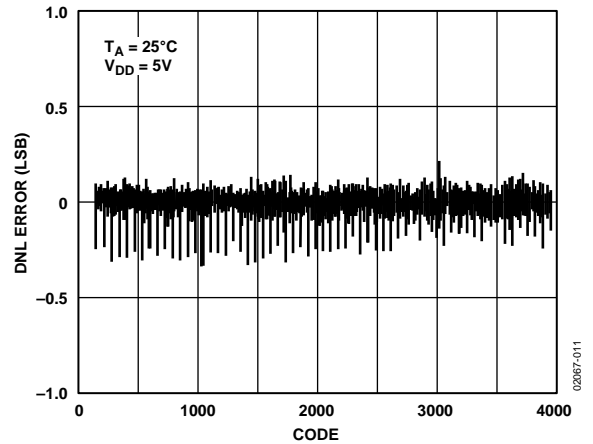

Figure 11. AD5327 DNL



Figure 12. AD5307 INL Error and DNL Error vs. V_{REF}



Figure 15. Offset Error and Gain Error vs. V_{DD}



Figure 13. AD5307 INL Error and DNL Error vs. Temperature

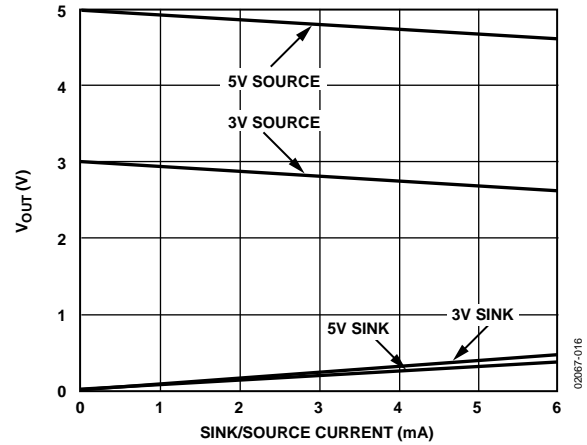

Figure 16. V_{OUT} Source and Sink Current Capability



Figure 14. AD5307 Offset Error and Gain Error vs. Temperature

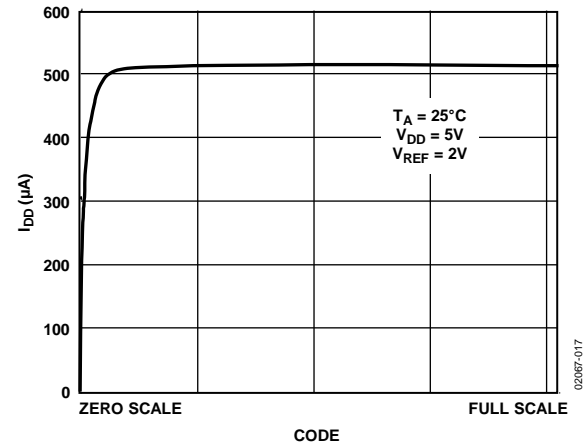

Figure 17. Supply Current vs. DAC Code

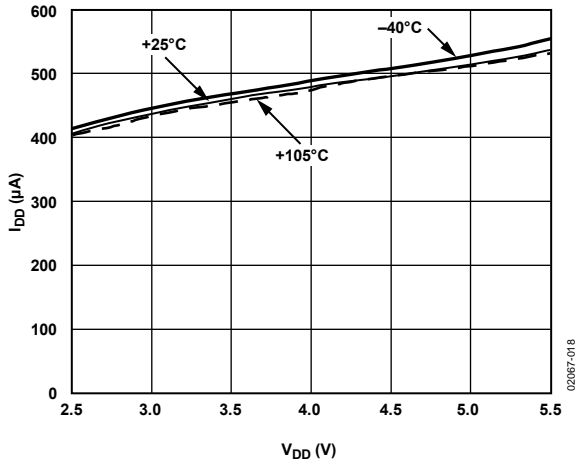

Figure 18. Supply Current vs. Supply Voltage



Figure 21. Half-Scale Settling (1/4 to 3/4 Scale Code Change)

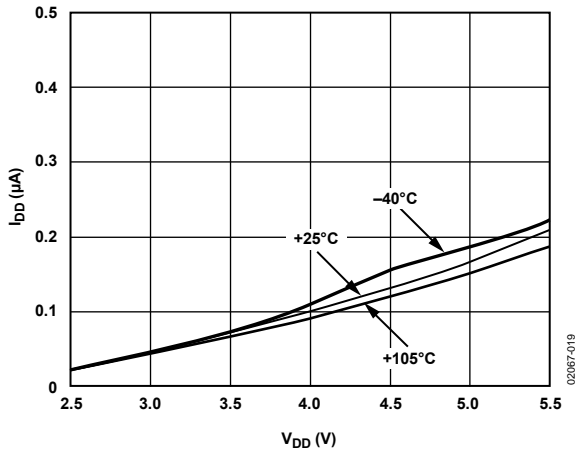

Figure 19. Power-Down Current vs. Supply Voltage

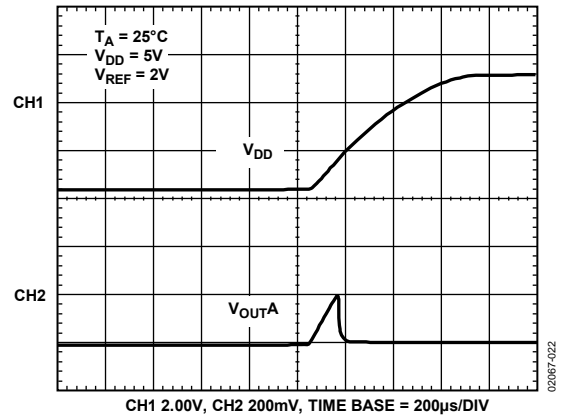

Figure 22. Power-On Reset to 0 V

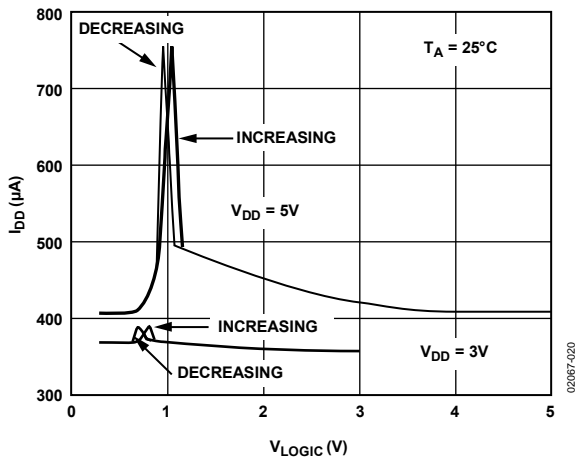

Figure 20. Supply Current vs. Logic Input Voltage for SCLK and DIN Increasing and Decreasing



Figure 23. Exiting Power-Down to Midscale



Figure 24. I_{DD} Histogram with $V_{DD} = 3\text{ V}$ and $V_{DD} = 5\text{ V}$



Figure 27. Full-Scale Error vs. V_{REF}



Figure 25. AD5327 Major-Code Transition Glitch Energy

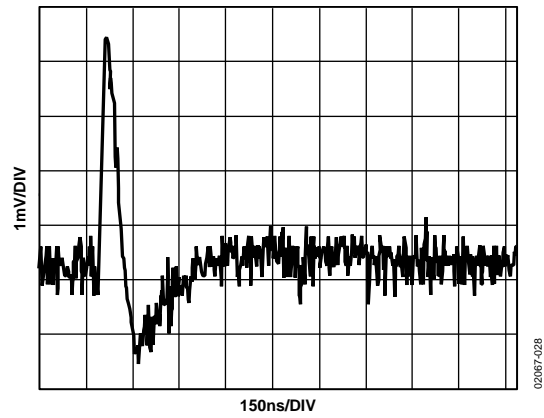

Figure 28. DAC-to-DAC Crosstalk

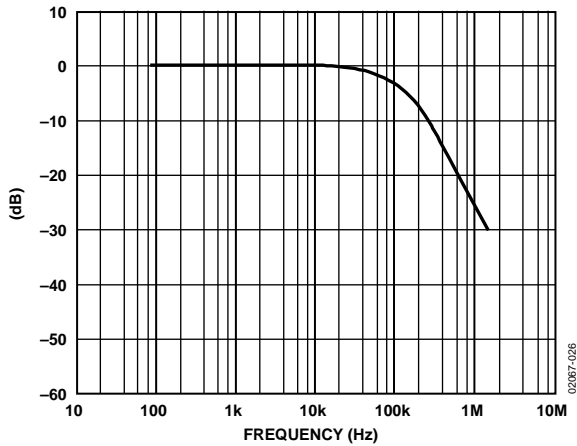

Figure 26. Multiplying Bandwidth (Small-Signal Frequency Response)

TERMINOLOGY

Relative Accuracy

For the DAC, relative accuracy, or integral nonlinearity (INL), is a measure of the maximum deviation in LSB from a straight line passing through the endpoints of the DAC transfer function. Figure 6 through Figure 8 show plots of typical INL vs. code.

Differential Nonlinearity

Differential nonlinearity (DNL) is the difference between the measured change and the ideal 1 LSB change between any two adjacent codes. A specified differential nonlinearity of ± 1 LSB maximum ensures monotonicity. This DAC is guaranteed monotonic by design. Figure 9 through Figure 11 show plots of typical DNL vs. code.

Offset Error

Offset error is a measure of the deviation in the output voltage from 0 V when zero-code is loaded to the DAC (see Figure 29 and Figure 30.) It can be negative or positive. It is expressed in millivolts.

Gain Error

Gain error is a measure of the span error of the DAC. It is the deviation in slope of the actual DAC transfer characteristic from the ideal expressed as a percentage of the full-scale range.

Offset Error Drift

Offset error drift is a measure of the change in offset error with changes in temperature. It is expressed in (ppm of full-scale range)/ $^{\circ}$ C.

Gain Error Drift

Gain error drift is a measure of the change in gain error with changes in temperature. It is expressed in (ppm of full-scale range)/ $^{\circ}$ C.

DC Power Supply Rejection Ratio (PSRR)

PSRR indicates how the output of the DAC is affected by changes in the supply voltage. It is the ratio of the change in V_{OUT} to a change in V_{DD} for full-scale output of the DAC. It is measured in decibels. V_{REF} is held at 2 V, and V_{DD} is varied $\pm 10\%$.

DC Crosstalk

DC crosstalk is the dc change in the output level of one DAC in response to a change in the output of another DAC. It is measured with a full-scale output change on one DAC while monitoring another DAC. It is expressed in microvolts.

Reference Feedthrough

Reference feedthrough is the ratio of the amplitude of the signal at the DAC output to the reference input when the DAC output is not being updated (that is, \overline{LDAC} is high). It is expressed in decibels.

Channel-to-Channel Isolation

Channel-to-channel isolation is the ratio of the amplitude of the signal at the output of one DAC to a sine wave on the reference input of another DAC. It is measured in decibels.

Major-Code Transition Glitch Energy

Major-code transition glitch energy is the energy of the impulse injected into the analog output when the code in the DAC register changes state. It is normally specified as the area of the glitch in nV-s and is measured when the digital code is changed by 1 LSB at the major carry transition (011 . . . 11 to 100 . . . 00 or 100 . . . 00 to 011 . . . 11).

Digital Feedthrough

Digital feedthrough is a measure of the impulse injected into the analog output of a DAC from the digital input pins of the device, but it is measured when the DAC is not being written to (\overline{SYNC} held high). It is specified in nV-s and is measured with a full-scale change on the digital input pins, that is, from all 0s to all 1s or vice versa.

Digital Crosstalk

Digital crosstalk is the glitch impulse transferred to the output of one DAC at midscale in response to a full-scale code change (all 0s to all 1s or vice versa) in the input register of another DAC. It is measured in standalone mode and is expressed in nV-s.

Analog Crosstalk

Analog crosstalk is the glitch impulse transferred to the output of one DAC due to a change in the output of another DAC. It is measured by loading one of the input registers with a full-scale code change (all 0s to all 1s or vice versa) while keeping \overline{LDAC} high, and then pulsing \overline{LDAC} low and monitoring the output of the DAC whose digital code has not changed. The area of the glitch is expressed in nV-s.

DAC-to-DAC Crosstalk

DAC-to-DAC crosstalk is the glitch impulse transferred to the output of one DAC due to a digital code change and subsequent output change of another DAC. This includes both digital and analog crosstalk. It is measured by loading one of the DACs with a full-scale code change (all 0s to all 1s or vice versa) with \overline{LDAC} low while monitoring the output of another DAC. The energy of the glitch is expressed in nV-s.

Multiplying Bandwidth

The amplifiers within the DAC have a finite bandwidth, and the multiplying bandwidth is a measure of this. A sine wave on the reference (with full-scale code loaded to the DAC) appears on the output. The multiplying bandwidth is the frequency at which the output amplitude falls to 3 dB below the input.

Total Harmonic Distortion (THD)

THD is the difference between an ideal sine wave and its attenuated version using the DAC. The sine wave is used as the reference for the DAC, and the THD is a measure of the harmonics present on the DAC output. It is measured in decibels.

TRANSFER FUNCTION



Figure 29. Transfer Function with Negative Offset



Figure 30. Transfer Function with Positive Offset ($V_{REF} = V_{DD}$)

FUNCTIONAL DESCRIPTION

The AD5307/AD5317/AD5327 are quad resistor-string DACs fabricated on a CMOS process with resolutions of 8, 10, and 12 bits respectively. Each contains four output buffer amplifiers and is written to via a 3-wire serial interface. They operate from single supplies of 2.5 V to 5.5 V, and the output buffer amplifiers provide rail-to-rail output swing with a slew rate of 0.7 V/μs. DAC A and DAC B share a common reference input, V_{REFAB}. DAC C and DAC D share a common reference input, V_{REFCD}. Each reference input can be buffered to draw virtually no current from the reference source, or can be unbuffered to give a reference input range of 0.25 V to V_{DD}. The devices have a power-down mode in which all DACs can be completely turned off with a high impedance output.

DIGITAL-TO-ANALOG SECTION

The architecture of one DAC channel consists of a resistor-string DAC followed by an output buffer amplifier. The voltage at the V_{REF} pin provides the reference voltage for the corresponding DAC. Figure 31 shows a block diagram of the DAC architecture. Because the input coding to the DAC is straight binary, the ideal output voltage is given by

$$V_{OUT} = \frac{V_{REF} \times D}{2^N}$$

where:

D is the decimal equivalent of the binary code that is loaded to the DAC register:

- 0 to 255 for AD5307 (8 bits).
- 0 to 1023 for AD5317 (10 bits).
- 0 to 4095 for AD5327 (12 bits).

N is the DAC resolution.

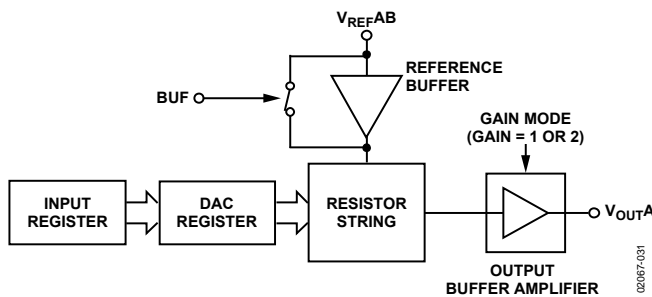

Figure 31. Single DAC Channel Architecture

RESISTOR STRING

The resistor string section is shown in Figure 32. It is simply a string of resistors, each of value R. The digital code loaded to the DAC register determines at which node on the string the voltage is tapped off to be fed into the output amplifier. The voltage is tapped off by closing one of the switches connecting the string to the amplifier. Because it is a string of resistors, it is guaranteed monotonic.

DAC REFERENCE INPUTS

There is a reference pin for each pair of DACs. The reference inputs are buffered but can also be individually configured as unbuffered. The advantage with the buffered input is the high impedance it presents to the voltage source driving it. However, if the unbuffered mode is used, the user can have a reference voltage as low as 0.25 V and as high as V_{DD}, because there is no restriction due to headroom and footroom of the reference amplifier.

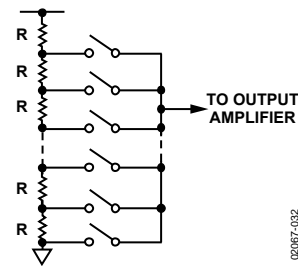

Figure 32. Resistor String

If there is a buffered reference in the circuit (for example, REF192), there is no need to use the on-chip buffers of the AD5307/AD5317/AD5327. In unbuffered mode, the input impedance is still large at typically 90 kΩ per reference input for 0 V to V_{REF} mode and 45 kΩ or 0 V to 2 V_{REF} mode.

The buffered/unbuffered option is controlled by the BUF bit in the data-word. The BUF bit setting applies to whichever DAC is selected.

OUTPUT AMPLIFIER

The output buffer amplifier is capable of generating output voltages to within 1 mV of either rail. Its actual range depends on the value of V_{REF} , GAIN, offset error, and gain error.

If a gain of 1 is selected (GAIN = 0), the output range is 0.001 V to V_{REF} .

If a gain of 2 is selected (GAIN = 1), the output range is 0.001 V to $2 V_{REF}$. Because of clamping, however, the maximum output is limited to $V_{DD} - 0.001$ V.

The output amplifier is capable of driving a load of 2 k Ω to GND or V_{DD} in parallel with 500 pF to GND or V_{DD} . The source and sink capabilities of the output amplifier can be seen in Figure 16.

The slew rate is 0.7 V/ μ s, with a half-scale settling time to ± 0.5 LSB (at eight bits) of 6 μ s.

POWER-ON RESET

The AD5307/AD5317/AD5327 are each provided with a power-on reset function so that they power up in a defined state. The power-on state is

- Normal operation
- Reference inputs unbuffered
- 0 V to V_{REF} output range
- Output voltage set to 0 V

Both input and DAC registers are filled with 0s until a valid write sequence is made to the device. This is particularly useful in applications where it is important to know the state of the DAC outputs while the device is powering up.

SERIAL INTERFACE

The AD5307/AD5317/AD5327 are controlled over versatile 3-wire serial interfaces that operate at clock rates of up to 30 MHz and are compatible with SPI, QSPI, MICROWIRE, and DSP interface standards.

INPUT SHIFT REGISTER

The input shift register is 16 bits wide. Data is loaded into the device as a 16-bit word under the control of a serial clock input, SCLK. The timing diagram for this operation is shown in Figure 3. The 16-bit word consists of four control bits followed by 8, 10, or 12 bits of DAC data, depending on the device type. Data is loaded MSB first (Bit 15), and the first two bits determine whether the data is for DAC A, DAC B, DAC C, or DAC D. Bit 13 and Bit 12 control the operating mode of the DAC. Bit 13 is GAIN, which determines the output range of the part. Bit 12 is BUF, which controls whether the reference inputs are buffered or unbuffered.

Table 6. Address Bits for the AD53x7

A1 (Bit 15)	A0 (Bit 14)	DAC Addressed
0	0	DAC A
0	1	DAC B
1	0	DAC C
1	1	DAC D

CONTROL BITS

GAIN controls the output range of the addressed DAC.

- 0: output range of 0 V to V_{REF} .
- 1: output range of 0 V to $2 V_{REF}$.

BUF controls whether reference of the addressed DAC is buffered or unbuffered.

- 0: unbuffered reference.
- 1: buffered reference.

The AD5327 uses all 12 bits of DAC data; the AD5317 uses 10 bits and ignores the 2 LSBs. The AD5307 uses eight bits and ignores the last four bits. The data format is straight binary, with all 0s corresponding to 0 V output and all 1s corresponding to full-scale output ($V_{REF} - 1 \text{ LSB}$).

The $\overline{\text{SYNC}}$ input is a level-triggered input that acts as a frame synchronization signal and chip enable. Data can be transferred into the device only while $\overline{\text{SYNC}}$ is low. To start the serial data transfer, $\overline{\text{SYNC}}$ should be taken low, observing the minimum $\overline{\text{SYNC}}$ to SCLK falling edge set-up time, t_s . After $\overline{\text{SYNC}}$ goes low, serial data is shifted into the device's input shift register on the falling edges of SCLK for 16 clock pulses. In standalone mode ($\text{DCEN} = 0$), any data and clock pulses after the 16th falling edge of SCLK are ignored, and no further serial data transfer can occur until $\overline{\text{SYNC}}$ is taken high and low again.

$\overline{\text{SYNC}}$ can be taken high after the falling edge of the 16th SCLK pulse, observing the minimum SCLK falling edge to $\overline{\text{SYNC}}$ rising edge time, t_r .

After the end of serial data transfer, data is automatically transferred from the input shift register to the input register of the selected DAC. If $\overline{\text{SYNC}}$ is taken high before the 16th falling edge of SCLK, the data transfer is aborted and the DAC input registers are not updated.

When data has been transferred into the input register of a DAC, the corresponding DAC register and DAC output can be updated by taking $\overline{\text{LDAC}}$ low. $\overline{\text{CLR}}$ is an active low, asynchronous clear that clears the input registers and DAC registers to all 0s.

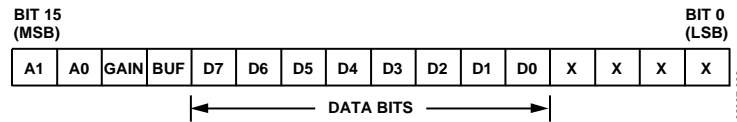

Figure 33. AD5307 Input Shift Register Contents



Figure 34. AD5317 Input Shift Register Contents

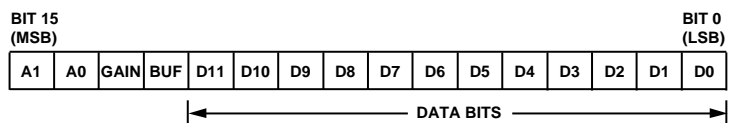

Figure 35. AD5327 Input Shift Register Contents

LOW POWER SERIAL INTERFACE

To minimize the power consumption of the device, the interface powers up fully only when the device is being written to, that is, on the falling edge of $\overline{\text{SYNC}}$. The SCLK and DIN input buffers are powered down on the rising edge of $\overline{\text{SYNC}}$.

DAISY CHAINING

For systems that contain several DACs, or where the user wishes to read back the DAC contents for diagnostic purposes, the SDO pin can be used to daisy-chain several devices together and provide serial readback.

By connecting the DCEN (daisy-chain enable) pin high, the daisy-chain mode is enabled. It is tied low in the case of standalone mode. In daisy-chain mode, the internal gating on SCLK is disabled. The SCLK is continuously applied to the input shift register when $\overline{\text{SYNC}}$ is low. If more than 16 clock pulses are applied, the data ripples out of the shift register and appears on the SDO line. This data is clocked out on the rising edge of SCLK and is valid on the falling edge. By connecting this line to the DIN input on the next DAC in the chain, a multi-DAC interface is constructed. Each DAC in the system requires 16 clock pulses; therefore, the total number of clock cycles must equal $16N$, where N is the total number of devices in the chain. When the serial transfer to all devices is complete, $\overline{\text{SYNC}}$ should be taken high. This prevents any further data from being clocked into the input shift register.

A continuous SCLK source can be used if $\overline{\text{SYNC}}$ is held low for the correct number of clock cycles. Alternatively, a burst clock containing the exact number of clock cycles can be used and $\overline{\text{SYNC}}$ can be taken high some time later.

When the transfer to all input registers is complete, a common $\overline{\text{LDAC}}$ signal updates all DAC registers and all analog outputs are updated simultaneously.

DOUBLE-BUFFERED INTERFACE

The AD5307/AD5317/AD5327 DACs have double-buffered interfaces consisting of two banks of registers: input registers and DAC registers. The input registers are connected directly to the input shift register and the digital code is transferred to the relevant input register on completion of a valid write sequence. The DAC registers contain the digital code used by the resistor strings.

Access to the DAC registers is controlled by the $\overline{\text{LDAC}}$ pin. When the $\overline{\text{LDAC}}$ pin is high, the DAC registers are latched and the input registers can change state without affecting the contents of the DAC registers. When $\overline{\text{LDAC}}$ is brought low, however, the DAC registers become transparent and the contents of the input registers are transferred to them.

The double-buffered interface is useful if the user requires simultaneous updating of all DAC outputs. The user can write to three of the input registers individually and then, by bringing $\overline{\text{LDAC}}$ low when writing to the remaining DAC input register, all outputs update simultaneously.

These parts each contain an extra feature whereby a DAC register is not updated unless its input register has been updated since the last time $\overline{\text{LDAC}}$ was brought low. Normally, when $\overline{\text{LDAC}}$ is brought low, the DAC registers are filled with the contents of the input registers. In the case of the AD5307/AD5317/AD5327, the DAC register updates only if the input register has changed since the last time the DAC register was updated, thereby removing unnecessary digital crosstalk.

LOAD DAC INPUT ($\overline{\text{LDAC}}$)

$\overline{\text{LDAC}}$ transfers data from the input registers to the DAC registers and therefore updates the outputs. Use of the $\overline{\text{LDAC}}$ function enables double buffering of the DAC data, GAIN, and BUF. There are two $\overline{\text{LDAC}}$ modes: synchronous and asynchronous.

Synchronous Mode

In this mode, the DAC registers are updated after new data is read from on the falling edge of the 16th SCLK pulse. $\overline{\text{LDAC}}$ can be tied permanently low or pulsed as in Figure 3.

Asynchronous Mode

In this mode, the outputs are not updated at the same time that the input registers are written to. When $\overline{\text{LDAC}}$ goes low, the DAC registers are updated with the contents of the input register.

POWER-DOWN MODE

The AD5307/AD5317/AD5327 have low power consumption, typically dissipating 1.2 mW with a 3 V supply and 2.5 mW with a 5 V supply. Power consumption can be further reduced when the DACs are not in use by putting them into power-down mode, which is selected by taking the PD pin low.

When the PD pin is high, all DACs work normally with a typical power consumption of 500 μA at 5 V (400 μA at 3 V). However, in power-down mode, the supply current falls to 300 nA at 5 V (90 nA at 3 V) when all DACs are powered down. Not only does the supply current drop, but the output stage is also internally switched from the output of the amplifier, making it an open circuit. This has the advantage that the output is three-state while the part is in power-down mode and provides a defined input condition for whatever is connected to the output of the DAC amplifier. The output stage is illustrated in Figure 36.

The bias generator, output amplifiers, resistor string, and all other associated linear circuitry are shut down when the power-down mode is activated. However, the contents of the registers are unaffected when in power-down. In fact, it is possible to load new data to the input registers and DAC registers during power-down. The DAC outputs update as soon as PD goes high.

The time to exit power-down is typically 2.5 μ s for $V_{DD} = 5$ V and 5 μ s when $V_{DD} = 3$ V. This is the time from the rising edge of \overline{PD} to when the output voltage deviates from its power-down voltage. See Figure 23 for a plot.

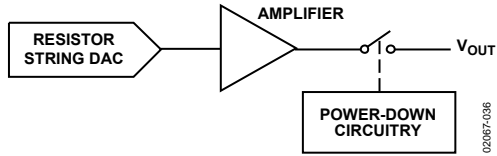

Figure 36. Output Stage During Power-Down

MICROPROCESSOR INTERFACING

ADSP-2101/ADSP-2103-to-AD5307/AD5317/AD5327 Interface

Figure 37 shows a serial interface between the AD5307/AD5317/AD5327 and the ADSP-2101/ADSP-2103. The ADSP-2101/ADSP-2103 should be set up to operate in the SPORT transmit alternate framing mode. The ADSP-2101/ADSP-2103 SPORT is programmed through the SPORT control register and should be configured as follows: internal clock operation, active low framing, 16-bit word length. Transmission is initiated by writing a word to the Tx register after SPORT is enabled. The data is clocked out on each rising edge of the DSP's serial clock and clocked into the AD5307/AD5317/AD5327 on the falling edge of the DAC's SCLK.

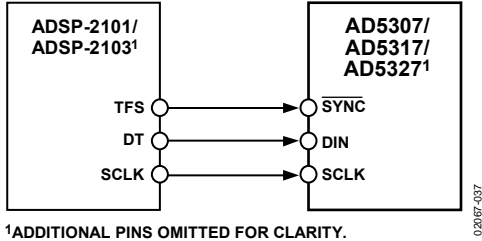
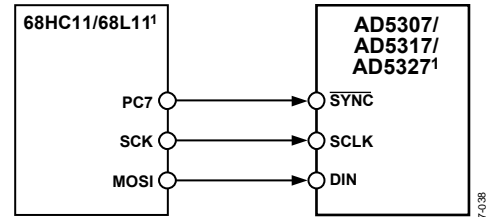

Figure 37. ADSP-2101/ADSP-2103-to-AD5307/AD5317/AD5327 Interface

68HC11/68L11-to-AD5307/AD5317/AD5327 Interface

Figure 38 shows a serial interface between the AD5307/AD5317/AD5327 and the 68HC11/68L11 microcontroller. SCK of the 68HC11/68L11 drives the SCLK of the AD5307/AD5317/AD5327, and the \overline{MOSI} output drives the serial data line (DIN) of the DAC. The \overline{SYNC} signal is derived from a port line (PC7). The set-up conditions for correct operation of this interface are as follows: The 68HC11/68L11 should be configured so that its CPOL bit is 0 and its CPHA bit is 1. When data is being transmitted to the DAC, the \overline{SYNC} line is taken low (PC7). With this configuration, data appearing on the MOSI output is valid on the falling edge of SCK. Serial data from the 68HC11/68L11 is transmitted in 8-bit bytes, with only eight falling clock edges occurring in the transmit cycle. Data is transmitted MSB first. To load data to the AD5307/AD5317/AD5327, PC7 is left low after the first eight bits are transferred and a second serial write operation is performed to the DAC. PC7 is taken high at the end of this procedure.



¹ADDITIONAL PINS OMITTED FOR CLARITY.

Figure 38. 68HC11/68L11-to-AD5307/AD5317/AD5327 Interface

80C51/80L51-to-AD5307/AD5317/AD5327 Interface

Figure 39 shows a serial interface between the AD5307/AD5317/AD5327 and the 80C51/80L51 microcontroller. The setup for the interface is as follows: TxD of the 80C51/80L51 drives SCLK of the AD5307/AD5317/AD5327, and RxD drives the serial data line of the part. The \overline{SYNC} signal is again derived from a bit-programmable pin on the port. In this case, Port Line P3.3 is used. When data is to be transmitted to the AD5307/AD5317/AD5327, P3.3 is taken low. The 80C51/80L51 transmits data only in 8-bit bytes; therefore, only eight falling clock edges occur in the transmit cycle. To load data to the DAC, P3.3 is left low after the first eight bits are transmitted, and a second write cycle is initiated to transmit the second byte of data. P3.3 is taken high following the completion of this cycle. The 80C51/80L51 outputs the serial data LSB first. The AD5307/AD5317/AD5327 require their data with the MSB as the first bit received. The 80C51/80L51 transmit routine should take this into account.

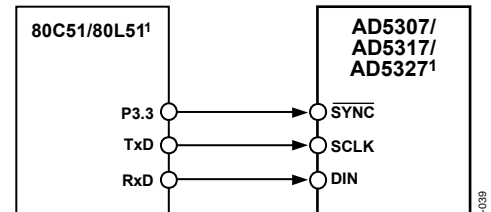

¹ADDITIONAL PINS OMITTED FOR CLARITY.

Figure 39. 80C51/80L51-to-AD5307/AD5317/AD5327 Interface

MICROWIRE-to-AD5307/AD5317/AD5327 Interface

Figure 40 shows an interface between the AD5307/AD5317/AD5327 and a MICROWIRE-compatible device. Serial data is shifted out on the falling edge of the serial clock, SK, and is clocked into the AD5307/AD5317/AD5327 on the rising edge of SK, which corresponds to the falling edge of the DAC's SCLK.

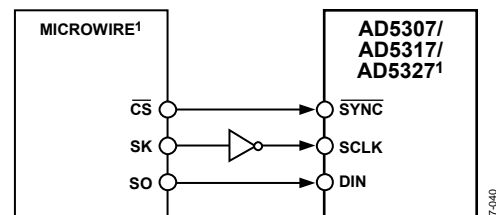

¹ADDITIONAL PINS OMITTED FOR CLARITY.

Figure 40. MICROWIRE-to-AD5307/AD5317/AD5327 Interface

APPLICATIONS

TYPICAL APPLICATION CIRCUIT

The AD5307/AD5317/AD5327 can be used with a wide range of reference voltages and offer full, one-quadrant multiplying capability over a reference range of 0.25 V to V_{DD} . More typically, these devices are used with a fixed precision reference voltage. Suitable references for 5 V operation are the AD780 and REF192 (2.5 V references). For 2.5 V operation, a suitable external reference would be the AD589, a 1.23 V band gap reference. Figure 41 shows a typical setup for the AD5307/AD5317/AD5327 when using an external reference.

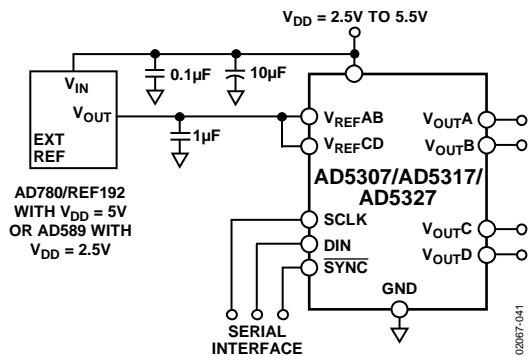

Figure 41. AD5307/AD5317/AD5327 Using a 2.5 V External Reference

DRIVING V_{DD} FROM THE REFERENCE VOLTAGE

If an output range of 0 V to V_{DD} is required when the reference inputs are configured as unbuffered, the simplest solution is to connect the reference input to V_{DD} . Because this supply can be noisy and not very accurate, the AD5307/AD5317/AD5327 can be powered from the reference voltage, for example, from a 5 V reference such as the REF195, which outputs a steady supply voltage. The typical current required from the REF195 with no load on the DAC outputs is 500 μ A supply current and \approx 112 μ A into the reference inputs (if unbuffered). When the DAC outputs are loaded, the REF195 also needs to supply the current to the loads. The total current required with a 10 k Ω load on each output is

$$612 \mu\text{A} + 4 (5 \text{ V}/10 \text{ k}\Omega) = 2.6 \text{ mA}$$

The load regulation of the REF195 is typically 2 ppm/mA, which results in an error of 5.2 ppm (26 μ V) for the 2.6 mA current drawn from it. This corresponds to a 0.0013 LSB error at eight bits and a 0.021 LSB error at 12 bits.

BIPOLAR OPERATION

The AD5307/AD5317/AD5327 are designed for single-supply operation, but a bipolar output range is also possible using the circuit shown in Figure 42. This circuit provides an output voltage range of 5 V. Rail-to-rail operation at the amplifier output is achievable by using an AD820 or an OP295 as the output amplifier.

The output voltage for any input code can be calculated as follows:

$$V_{OUT} = \left[\frac{(REFIN \times D/2^N) \times (R1 + R2)}{R1} \right] - REFIN \times (R2/R1)$$

where:

D is the decimal equivalent of the code loaded to the DAC.

N is the DAC resolution.

$REFIN$ is the reference voltage input.

When $REFIN = 5 \text{ V}$, $R1 = R2 = 10 \text{ k}\Omega$,

$$V_{OUT} = (10 \times D/2^N) - 5 \text{ V}$$

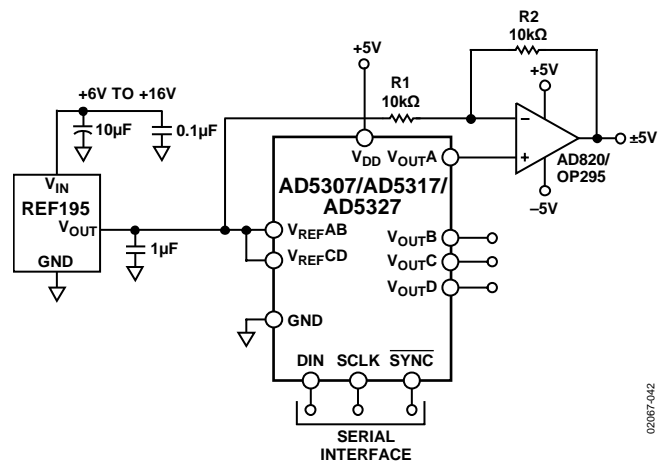

Figure 42. Bipolar Operation with the AD5307/AD5317/AD5327

OPTO-ISOLATED INTERFACE FOR PROCESS-CONTROL APPLICATIONS

The AD5307/AD5317/AD5327 each have a versatile 3-wire serial interface, making them ideal for generating accurate voltages in process-control and industrial applications. Due to noise, safety requirements, or distance, it may be necessary to isolate the AD5307/AD5317/AD5327 from the controller. This can easily be achieved by using opto-isolators capable of providing isolation in excess of 3 kV. The actual data rate achieved can be limited by the type of optocouplers chosen. The serial loading structure of the AD5307/AD5317/AD5327 makes them ideally suited for use in opto-isolated applications. Figure 43 shows an opto-isolated interface to the AD5307/AD5317/AD5327 where DIN, SCLK, and SYNC are driven from optocouplers. The power supply to the part should also be isolated. This is done by using a transformer. On the DAC side of the transformer, a 5 V regulator provides the 5 V supply required for the AD5307/AD5317/AD5327.



Figure 43. AD5307 in an Opto-Isolated Interface

DECODING MULTIPLE AD5307/AD5317/AD5327 DEVICES

The SYNC pin on the AD5307/AD5317/AD5327 can be used in applications to decode a number of DACs. In this application, all DACs in the system receive the same serial clock and serial data, but the SYNC to only one of the devices is active at any given time, allowing access to four channels in this 16-channel system. The 74HC139 is used as a 2-to-4 line decoder to address any of the DACs in the system. To prevent timing errors, the enable input should be brought to its inactive state while the coded address inputs are changing state. Figure 44 shows a diagram of a typical setup for decoding multiple AD5307 devices in a system.

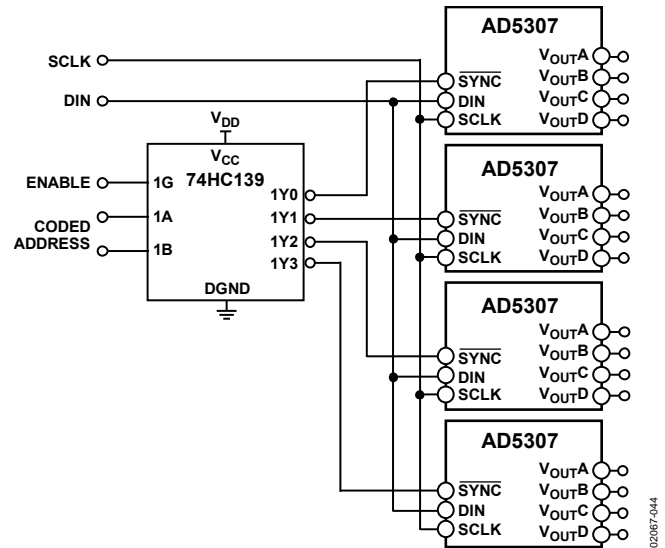

Figure 44. Decoding Multiple AD5307 Devices in a System

AD5307/AD5317/AD5327 AS DIGITALLY PROGRAMMABLE WINDOW DETECTORS

A digitally programmable upper/lower limit detector using two of the DACs in the AD5307/AD5317/AD5327 is shown in Figure 45. The upper and lower limits for the test are loaded to DAC A and DAC B, which, in turn, set the limits on the CMP04. If the signal at the VIN input is not within the programmed window, an LED indicates the fail condition. Similarly, DAC C and DAC D can be used for window detection on a second VIN signal.



Figure 45. Window Detection

DAISY CHAINING

For systems that contain several DACs, or where the user wishes to read back the DAC contents for diagnostic purposes, the SDO pin can be used to daisy-chain several devices together and provide serial readback. Figure 4 shows the timing diagram for daisy-chain applications. The daisy-chain mode is enabled by connecting DCEN high (see Figure 46).



¹ADDITIONAL PINS OMITTED FOR CLARITY.

Figure 46. AD5307 in Daisy-Chain Mode

POWER SUPPLY BYPASSING AND GROUNDING

In any circuit where accuracy is important, careful consideration of the power supply and ground return layout helps to ensure the rated performance. The printed circuit board on which the AD5307/AD5317/AD5327 are mounted should be designed so that the analog and digital sections are separated and confined to certain areas of the board. If the AD5307/AD5317/AD5327 are in a system where multiple devices require an AGND-to-DGND connection, the connection should be made at one point only. The star ground point should be established as close as possible to the device. The AD5307/AD5317/AD5327 should have ample supply bypassing of 10 μ F in parallel with 0.1 μ F on the supply located as close to the package as possible, ideally right up against the device. The 10 μ F capacitors are the tantalum bead type. The 0.1 μ F capacitor should have low effective series resistance (ESR) and low effective series inductance (ESI), such as is typical of the common ceramic types that provide a low impedance path to ground at high frequencies to handle transient currents due to internal logic switching.

The power supply lines of the AD5307/AD5317/AD5327 should use as large a trace as possible to provide low impedance paths and reduce the effects of glitches on the power supply line. Components, such as clocks, with fast switching signals should be shielded with digital ground to avoid radiating noise to other parts of the board, and they should never be run near the reference inputs. Avoid crossover of digital and analog signals. Traces on opposite sides of the board should run at right angles to each other. This reduces the effects of feedthrough on the board. A microstrip technique is by far the best, but it is not always possible with a double-sided board. In this technique, the component side of the board is dedicated to ground plane, and signal traces are placed on the solder side.

Table 7. Overview of AD53xx Serial Devices

Part No.	Resolution	No. of DACs	DNL	Interface	Settling Time (μ s)	Package	Pin
SINGLES							
AD5300	8	1	± 0.25	SPI	4	SOT-23, MSOP	6, 8
AD5310	10	1	± 0.5	SPI	6	SOT-23, MSOP	6, 8
AD5320	12	1	± 1.0	SPI	8	SOT-23, MSOP	6, 8
AD5301	8	1	± 0.25	2-Wire	6	SOT-23, MSOP	6, 8
AD5311	10	1	± 0.5	2-Wire	7	SOT-23, MSOP	6, 8
AD5321	12	1	± 1.0	2-Wire	8	SOT-23, MSOP	6, 8
DUALS							
AD5302	8	2	± 0.25	SPI	6	MSOP	8
AD5312	10	2	± 0.5	SPI	7	MSOP	8
AD5322	12	2	± 1.0	SPI	8	MSOP	8
AD5303	8	2	± 0.25	SPI	6	TSSOP	16
AD5313	10	2	± 0.5	SPI	7	TSSOP	16
AD5323	12	2	± 1.0	SPI	8	TSSOP	16
QUADS							
AD5304	8	4	± 0.25	SPI	6	MSOP	10
AD5314	10	4	± 0.5	SPI	7	MSOP	10
AD5324	12	4	± 1.0	SPI	8	MSOP	10
AD5305	8	4	± 0.25	2-Wire	6	MSOP	10
AD5315	10	4	± 0.5	2-Wire	7	MSOP	10
AD5325	12	4	± 1.0	2-Wire	8	MSOP	10
AD5306	8	4	± 0.25	2-Wire	6	TSSOP	16
AD5316	10	4	± 0.5	2-Wire	7	TSSOP	16
AD5326	12	4	± 1.0	2-Wire	8	TSSOP	16
AD5307	8	4	± 0.25	SPI	6	TSSOP	16
AD5317	10	4	± 0.5	SPI	7	TSSOP	16
AD5327	12	4	± 1.0	SPI	8	TSSOP	16
OCTALS							
AD5308	8	8	± 0.25	SPI	6	TSSOP	16
AD5318	10	8	± 0.5	SPI	7	TSSOP	16
AD5328	12	8	± 1.0	SPI	8	TSSOP	16

Table 8. Overview of AD53xx Parallel Devices

Part No.	Resolution	DNL	V_{REF} Pin	Settling Time (μ s)	Additional Pin Functions				Package	Pin
					BUF	GAIN	HBEN	CLR		
SINGLES										
AD5330	8	± 0.25	1	6	✓	✓		✓	TSSOP	20
AD5331	10	± 0.5	1	7		✓		✓	TSSOP	20
AD5340	12	± 1.0	1	8	✓	✓		✓	TSSOP	24
AD5341	12	± 1.0	1	8	✓	✓	✓	✓	TSSOP	20
DUALS										
AD5332	8	± 0.25	2	6				✓	TSSOP	20
AD5333	10	± 0.5	2	7	✓	✓		✓	TSSOP	24
AD5342	12	± 1.0	2	8	✓	✓		✓	TSSOP	28
AD5343	12	± 1.0	1	8			✓	✓	TSSOP	20
QUADS										
AD5334	8	± 0.25	2	6		✓		✓	TSSOP	24
AD5335	10	± 0.5	2	7			✓	✓	TSSOP	24
AD5336	10	± 0.5	4	7		✓		✓	TSSOP	28
AD5344	12	± 1.0	4	8				✓	TSSOP	28

OUTLINE DIMENSIONS

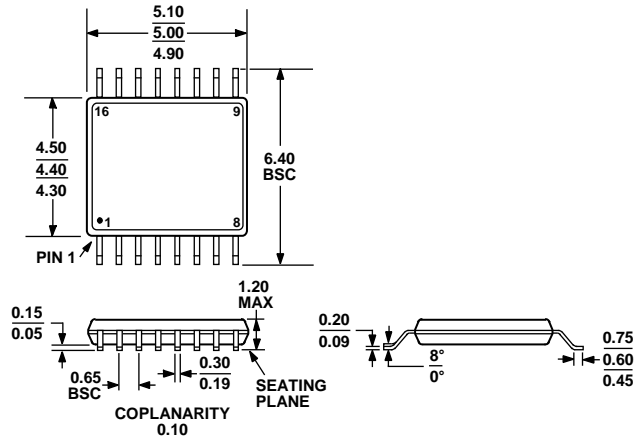

COMPLIANT TO JEDEC STANDARDS MO-153-AB

Figure 47. 16-Lead Thin Shrink Small Outline Package [TSSOP] (RU-16)

Dimensions shown in millimeters

ORDERING GUIDE

Model ¹	Temperature Range	Package Description	Package Option
AD5307ARUZ	-40°C to +105°C	16-Lead Thin Shrink Small Outline Package [TSSOP]	RU-16
AD5307ARUZ-REEL7	-40°C to +105°C	16-Lead Thin Shrink Small Outline Package [TSSOP]	RU-16
AD5307BRU-REEL	-40°C to +105°C	16-Lead Thin Shrink Small Outline Package [TSSOP]	RU-16
AD5307BRUZ	-40°C to +105°C	16-Lead Thin Shrink Small Outline Package [TSSOP]	RU-16
AD5307BRUZ-REEL	-40°C to +105°C	16-Lead Thin Shrink Small Outline Package [TSSOP]	RU-16
AD5307BRUZ-REEL7	-40°C to +105°C	16-Lead Thin Shrink Small Outline Package [TSSOP]	RU-16
AD5317ARUZ	-40°C to +105°C	16-Lead Thin Shrink Small Outline Package [TSSOP]	RU-16
AD5317ARUZ-REEL7	-40°C to +105°C	16-Lead Thin Shrink Small Outline Package [TSSOP]	RU-16
AD5317BRU	-40°C to +105°C	16-Lead Thin Shrink Small Outline Package [TSSOP]	RU-16
AD5317BRU-REEL7	-40°C to +105°C	16-Lead Thin Shrink Small Outline Package [TSSOP]	RU-16
AD5317BRUZ	-40°C to +105°C	16-Lead Thin Shrink Small Outline Package [TSSOP]	RU-16
AD5317BRUZ-REEL	-40°C to +105°C	16-Lead Thin Shrink Small Outline Package [TSSOP]	RU-16
AD5317BRUZ-REEL7	-40°C to +105°C	16-Lead Thin Shrink Small Outline Package [TSSOP]	RU-16
AD5327ARUZ	-40°C to +105°C	16-Lead Thin Shrink Small Outline Package [TSSOP]	RU-16
AD5327BRU	-40°C to +105°C	16-Lead Thin Shrink Small Outline Package [TSSOP]	RU-16
AD5327BRUZ	-40°C to +105°C	16-Lead Thin Shrink Small Outline Package [TSSOP]	RU-16
AD5327BRUZ-REEL	-40°C to +105°C	16-Lead Thin Shrink Small Outline Package [TSSOP]	RU-16
AD5327BRUZ-REEL7	-40°C to +105°C	16-Lead Thin Shrink Small Outline Package [TSSOP]	RU-16

¹ Z = RoHS Compliant Part.

NOTES

NOTES

NOTES