

Assembly Instructions for - 37270

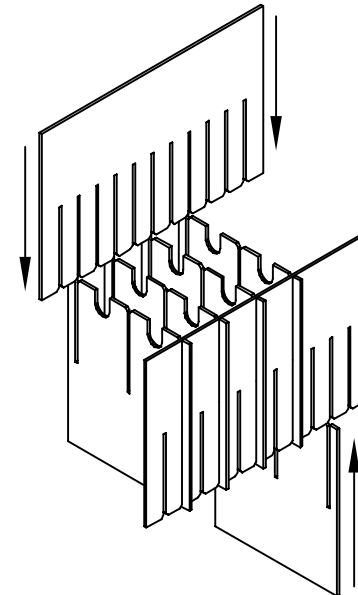
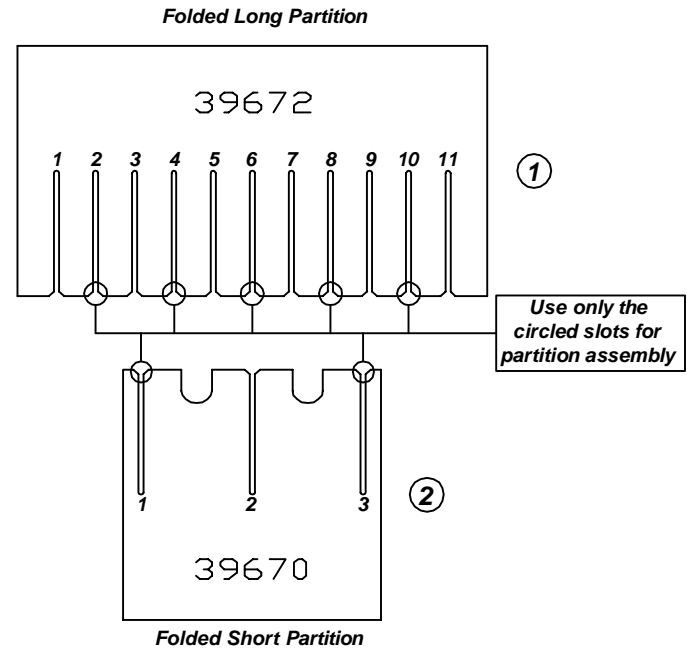
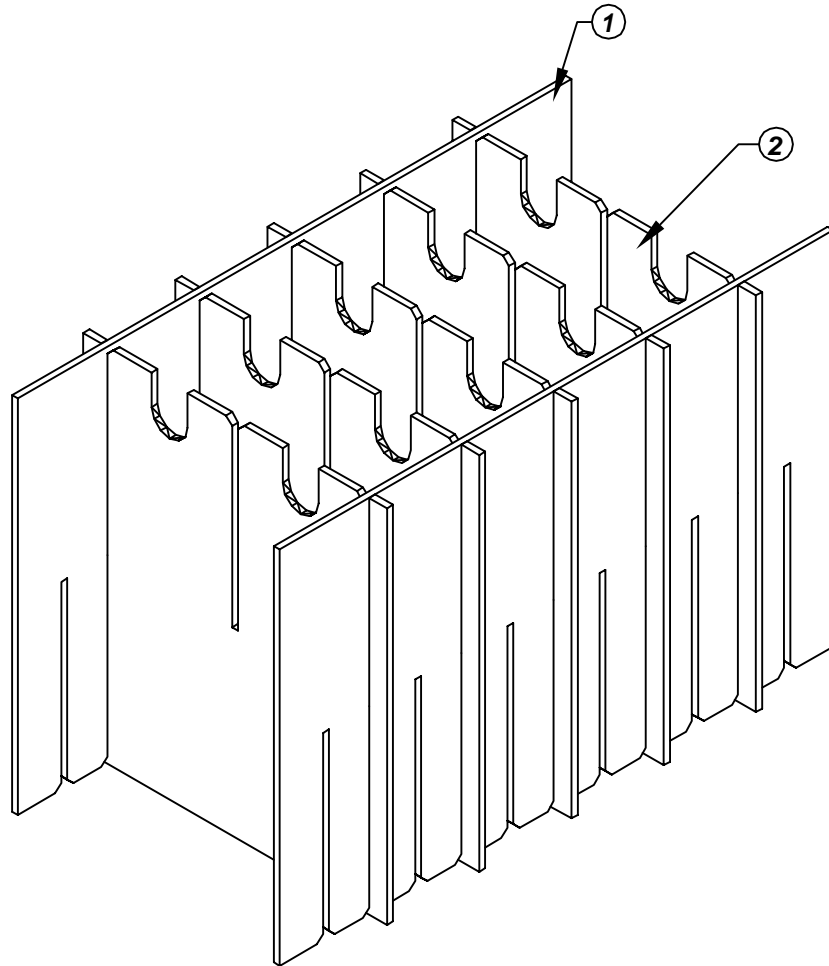

Made in America

F/N ①	Part # 39672	Dimensions: 30-1/4" x 23"	Description: 445-HLP Long Partition	Qty: 2
F/N ②	Part # 39670	Dimensions: 30-1/4" x 12-5/8"	Description: 445/408-HSP Short Partition	Qty: 5

37270 - 6 Cell Inplant Handler
Cell Size - 15-1/4" x 10-3/4" x 3-5/8"

Notes:
 For use with the following storage container & lid:
 37515 - Storage Container
 37552 - Lid

PROTEKTIVE PAK
 13520 MONTE VISTA AVENUE, CHINO, CA 91710
 PHONE (909) 627-2578, FAX (909) 363-7331
 ProtectivePak.com

PROTEKTIVE PAK
 BURIED CONDUCTIVE LAYER

DRAWING NUMBER
IPH-37270

DATE
 Nov.
 2007