

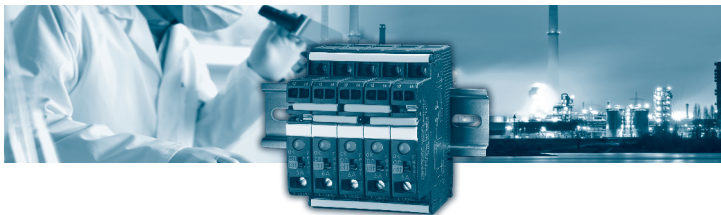

Instruction Manual

Electronic Circuit Protector ESX10-TA/-TB-DC 24 V



Warning
This device is only suitable for operation at 24 VDC (safety extra-low voltage). Direct connection of this device to a 110 V, 230 V or 400 V power system, or to power systems with a higher voltage, may consequently result in death, severe personal injury or substantial property damage. Only qualified personnel should work on or around this equipment. The product will function correctly and safely only if it is transported, stored, set up and installed as intended.

Caution
Electrostatic sensitive devices (ESD) – the device must be opened only by the manufacturer.

Disposal guideline
Packaging and packing aids can be recycled and should always be returned to use.

Note

More detailed information can be obtained from local E-T-A subsidiaries or from the homepage www.e-t-a.de. The product is subject to technical modifications. In case of doubt the German text takes precedence. If used under Ex conditions, this device must only be actuated of the immediate environment is verifiably not classified as a hazardous area. Automatic start-up of machinery after shut down must be prevented (Machinery Directive 2006/42/EC and EN 60204-1). In the event of a short circuit or overload the load circuit will be disconnected electronically by the ESX10-TA/-TB.

Installation instructions

The type ESX10-TA/-TB can be snapped onto symmetrical rail EN 60715. Please observe the marking of the ESX10-T signal inputs and outputs, connection diagrams etc. Before power up the cables have to be marked so as to prevent reverse polarity. The user should ensure that the cable cross sections of the relevant load circuit are suitable for the current rating of the ESX10-T used. In the event of Ex applications it has to be ensured that protection class IP 54 is achieved after installation in a UV-protected, fully enclosed room / control cabinet. IEC/EN60079-0 and IEC/EN 60079-14 have been observed for installation.

Safety
This device is not protected against reversed polarity of the input voltage. It has to be protected against overvoltage > 32 V.
Danger of explosion: Incorrect connection of cables can cause ignition. The output and the device are protected by an internal, non-exchangeable blade fuse. Use in aggressive mixed media was not tested. When mounted side-by-side without convection, the devices should not carry more than 80 % of its rated load with 100 % ON duty due to thermal effects.

Table

Current rating (A)	0.5	1	2	3	4	6	8	10	12
Max. load (A)	0.5	1	2	3	4	5	7	9	10.8

Specifications:

Protection class	to EN60529 housing IP20, terminals IP20
EMC	emitted interference to EN 61000-6-3 noise immunity to EN 61000-6-2
Insulation coordination	0.5 kV / pollution degree 2, re-inforced insulation in operating area to IEC60934 / IEC60664
CE logo	to 2014/30/EU and 2014/34/EU
UL	UL 2367, File # E306740 Solid State Overcurrent Protectors UL 508, File # E322549 Industrial Control Equipment ISA 12.12.01-2015, File # E320024
CSA	CSA C22.2 No: 14 File # 016186 CSA C22.2 No: 142 File # 016186 CSA C22.2 No: 213
ATEX	IEC/EN60079-0/-14/-15 Ⓜ II 3G Ex nA II B T4 Gc X

Ordering information

Type No.

ESX10 Electronic Circuit Protector, with current limitation

Mounting and design

TA rail mounting, without signal contact

TB rail mounting, with aux. contact and hole for signal busbars/jumpers

Version

1 standard, without physical isolation

Signal input

- 0 without signal input
- 1 with control input IN+ (only ESX10-T.-114)
- 2 with reset input RE (only ESX10-T.-124, ESX10-T.-127)

Signal outputs

- 0 without signal output (only ESX10-TA)
- 1 signal contact N/O
- 2 signal contact N/C
- 4 status output SF (only ESX10-T.-114, ESX10-T.-124)
- 7 inverse status output SF (only ESX10-T.-127)

Operating voltage

DC 24 V rated voltage DC 24 V

Current rating
0.5...12 A

Approvals
E ATEX

ESX10-TB-1 0 1-DC 24 V-6 A-E Ordering information

1 Description

Electronic circuit protector type ESX10-T is designed to ensure **selective** disconnection of DC 24 V load systems because it responds much faster to overload or short circuit conditions than the switch-mode power supply. This is achieved by active current limitation. The ESX10-T limits the highest possible current to 1.3 to 1.8 times the selected rated current of the circuit protector. Thus it is possible to switch on **capacitive loads of up to 20,000 µF**, but they are disconnected only in the event of an overload or short circuit.

For optimal alignment with the characteristics of the application the current rating of the ESX10-T can be selected in fixed values from 0.5 A...12 A. Failure and status indication are provided by a multicolour LED and an integral short-circuit-proof status output or a potential-free signal contact. Remote operation is possible by means of a remote reset signal or a remote ON/OFF control signal. The manual ON/OFF button allows separate actuation of individual load circuits.

Upon detection of overload or short circuit in the load circuit, the MOSFET of the load output will be blocked to interrupt the current flow. The load circuit can be re-activated via the remote electronic reset input, control input or manually by means of the ON/OFF button.

2 Technical Data (T_{ambient} = 25 °C, U_S = DC 24 V)

Operating data	
Operating voltage U _S	DC 24 V (18...32 V)
Current rating I _N	0.5 A, 1 A, 2 A, 3 A, 4 A, 6 A, 8 A, 10 A, 12 A
Closed current I _C	ON condition: typically 20...30 mA depending on signal output
Status indication by means of	<ul style="list-style-type: none"> • multicolour LED: • Green: <ul style="list-style-type: none"> - unit is ON, power-MOSFET is switched on - status output SF ON, supplies + DC 24 V • Orange: <ul style="list-style-type: none"> - in the event of overload or short circuit until electronic disconnection • Red: <ul style="list-style-type: none"> - unit electronically disconnected - load circuit/Power-MOSFET OFF • OFF: <ul style="list-style-type: none"> - manually switched off (S1 = OFF) or device dead - undervoltage (U_C < 8 V) - after switch-on till the end of the delay period • status output SF (option) • potential-free signal contact F (option) • ON/OFF/ condition of switch S1
Load circuit	
Load output	Power-MOSFET switching output (high side switch)
Overload disconnection	typically 1.1 x I _N (1.05...1.35 x I _N)
Short-circuit current I _K	Active current limitation with I _{LIMIT} = typically 1.8/1.5/1.4/4.3 x I _N depending on I _N (typical I _{LIMIT} - values see table 1)
Trip characteristic	active current limitation (see table 1)
Trip thresholds/trip times (t ₁ , t ₂) at overcurrent	<p>1. threshold: at I_{load} > typically 1.1 x I_N, t_{1, LIMIT} (see table 1) t₁ = typically 3s.</p> <p>2. threshold: at I_{load} = I_{LIMIT} t₂ = typically 100 ms...3 s.</p>
Temperature disconnection	internal temperature monitoring with electronic disconnection
Low voltage monitoring load output	with hysteresis, no reset required load "OFF" at U _S < 8 V
Starting delay t _{start}	typically 0.5 sec after every switch-on and after applying U _S
Disconnection of load circuit	electronic disconnection
Free-wheeling circuit	external free-wheeling diode recommended with inductive load
Several load outputs must not be connected in parallel	
Status output SF	ESX10-T.-114/-124/-127
Electrical data	plus-switching signal output, connects U _S to terminal 12 of module 17 plus nominal data: DC 24 V / max. 0.2 A (short circuit proof) status output is internally connected to GND with a 10 kOhm resistor

2 Technical Data (T_{ambient} = 25 °C, U_S = DC 24 V)

Status OUT	ESX10-TB-114/-124 (signal status OUT), at U _S = +24 V +24 V = S1 is ON, load output connected through 0V = S1 is ON, load output blocked and/or switch S1 is OFF red LED lighted
Status OUT	ESX10-TB-127 (signal status OUT inverted), at U _S = +24 V +24 V = S1 is ON, load output locked red LED lighted 0 V = S1 is ON, load output connected and/ or switch S1 is OFF.
OFF condition	0 V level at status output when: <ul style="list-style-type: none"> • switch S1 is in ON position, but device is still in switch-on delay • switch S1 is OFF, or control signal OFF, device is switched off • no operating voltage U_S
Signal output F	ESX10-T.-101/-102
Electrical data	potential-free signal contact max. DC 30 V/0.5 A, min. 10 V/10 mA
ON condition LED green	oltage U _S applied, switch S1 is in ON position no overload, no short circuit
OFF condition LED off	<ul style="list-style-type: none"> • device switched off (switch S1 is in OFF position) • no voltage U_S applied
Fault condition LED orange	overload condition > 1.1 x I _N up to electronic disconnection
Fault condition LED red	electronic disconnection upon overload or short circuit
ESX10-TB-101	single signal, make contact contact SC/SO-SI open
ESX10-TB-102	single signal, break contact contact SC/SO-SI closed
Fault	signal output fault conditions: <ul style="list-style-type: none"> • no operating voltage U_S • ON/OFF switch S1 is in OFF position • red LED lighted (electronic disconnection)
Reset input RE	ESX10-T.-124/-127
Electrical data	voltage: max. + DC 32 V high > DC 8 V ≤ DC 32 V low ≤ DC 3 V > 0 V power consumption typically 2.6 mA (+DC 24 V) min. pulse duration typically 10 ms
Reset signal RE terminal 22	The electronically blocked ESX10-TB-124/-127 may remotely be reset via an external momentary switch due to the falling edge of a +24 V pulse. A common reset signal can be applied to several devices simultaneously. Switched on devices remain unaffected.
Control input IN+	ESX10-T.-114
Electrical data	see reset input RE
Control signal IN+ terminal 21	+24V level (HIGH): device will be switched (terminal 21) on by a remote ON/OFF signal 0 V level (LOW): device will be switched off by a remote ON/OFF signal
Switch S1 ON/OFF	unit can only be switched on with S1 if a HIGH level is applied to IN+
LED display	ON: LED green / OFF: LED red
General data	
Fault-safe element	backup fuse for ESX10-T <u>not required</u> because of the integral redundant fail-safe element
Terminals	LINE+LOAD+0V
screen terminals	M4
max. cable cross section	
rigid and flexible	0.5 - 16 mm ²
flexible with wire end ferrule w/wo plastic sleeve	0.5 - 10 mm ²
wire stripping length	10 mm
tightening torque (EN 60934)	1.5 - 1.8 Nm
multi-lead connection	
(2 identical cables)	
rigid/flexible	0.5 - 4 mm ²
flexible with wire end ferrule without plastic sleeve	0.5 - 2.5 mm ²
flexible with TWIN wire end ferrule with plastic sleeve	0.5 - 6 mm ²

2 Technical Data ($T_{\text{ambient}} = 25\text{ }^{\circ}\text{C}$, $U_S = \text{DC } 24\text{ V}$)

Terminals	aux. contacts
screw terminals	M3
max. cable cross section	
flexible with wire end ferrule w/o plastic sleeve	0.25 – 2.5 mm ²
wire stripping length	8 mm
tightening torque (EN 60934)	0.5 – 0.6 Nm
Housing material	moulded
Mounting	symmetrical rail to EN 60715-35x7.5
Ambient temperature	0...+50 °C (without condensation, see EN 60204-1)
Storage temperature	-20...+70 °C
Humidity	96 hrs/95 % RH/40 °C to IEC 60068-2-78, test Cab, climate class 3K3 to EN 60721
Vibration	3 g, test to IEC 60068-2-6 test Fc
Degree of protectio	housing: IP20 EN 60529 terminals: IP20 EN 60529
EMC (EMC directive, CE logo)	emission: EN 61000-6-3 susceptibility: EN 61000-6-2
Insulation co-ordination (IEC 60934)	0.5 kV/2 pollution degree 2 re-inforced insulation in operating area
dielectric strength	max. DC 32 V (load circuit)
Insulation resistance (OFF condition)	n/a, only electronic disconnection
Dimensions (W x H x D)	12.5 x 80 x 83 mm
Mass	approx. 65 g

Schematic diagram ESX10-TB-124 (Example)

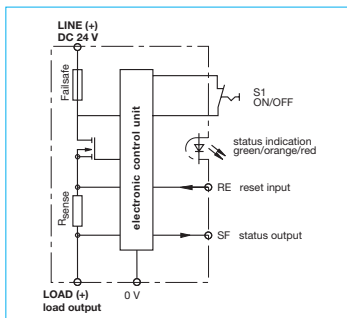

Time/Current characteristic curve ($T_A = 25\text{ }^{\circ}\text{C}$)

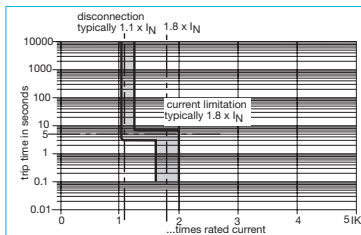

ESX10-T Signal inputs / outputs (wiring diagram)

ESX10-T signal inputs / outputs (schematic diagrams)

Auxiliary contacts are shown in OFF or error condition

ESX10-TA-100

without signal input/output

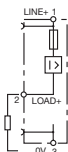

ESX10-TB-101

without signal input with signal output F (single signal, N/O)

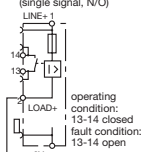

ESX10-TB-102

without signal input with signal output F (single signal, N/C)

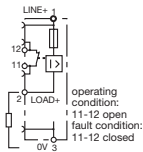

ESX10-TB-114

with control input IN+ (+DC 24 V) with status output SF (+24 V = load output ON)

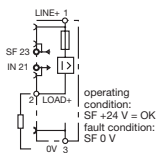

ESX10-TB-124

with reset input RE (+DC 24 V ↓) with status output SF (+24 V = load output ON)

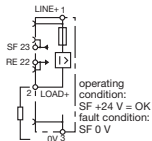

ESX10-TB-127

with reset input RE (+DC 24 V ↓) with inverse status output SF (0 V = load output ON)

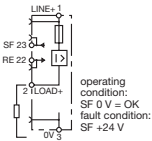

- The trip time is typically 3 s in the range between 1.1 and $1.8 \times I_N$ (e.g. ESX10-TB-...6 A)
- Electronic current limitation I_{lim} occurs at typically $1.8 \times I_N$ which means that under all overload conditions (independent of the power supply and the resistance of the load circuit) the max. overload before disconnection will not exceed $1.8 \times I_N$ times the current rating. The individual current limitation value I_{lim} depends on the current rating (see table). Trip time is between 100 ms and 3 sec (depending on overload or at short circuit).
- Without this current limitation a considerably higher overload current would flow in the event of an overload or short circuit.

Connection diagrams and application examples ESX10-T...

Signal contacts are shown in OFF or fault condition.

ESX10-TA-100

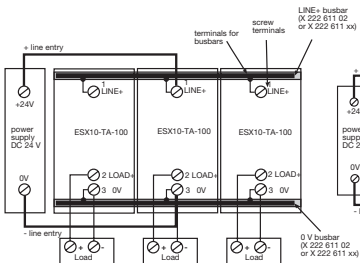

ESX10-TB-124
Single signalling with common reset

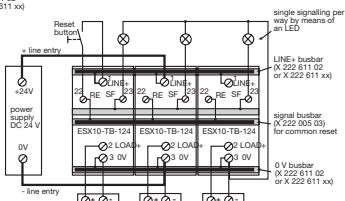

ESX10-TB-101

group signalling (series connection)

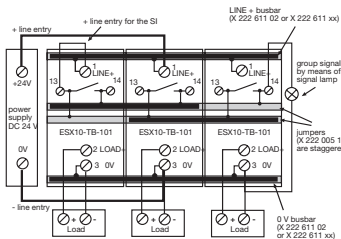

Application examples: line entry DC 24 V with protection of signal circuit and direct connection of loads
Auxiliary contacts are shown on the OFF of fault condition

ESX10-TB-101

Group signalisation (series connection)

Type ESX10-TA-100-DC24V-0.5A can be used as a supply module including protection of auxiliary circuit
Optional: Passive supply module AD-TX-EM01 (without protection)

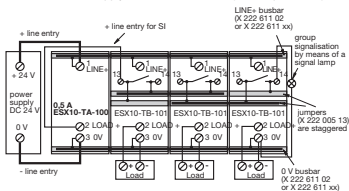

ESX10-TB-102

Single signalling with common line entry

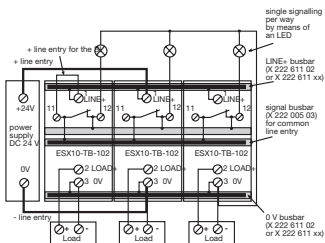

ESX10-TB-102

Single signalisation with common line entry

Type ESX10-TA-100-DC24V-0.5A can be used as a supply module including protection of auxiliary circuit
Optional: Passive supply module AD-TX-EM01 (without protection)

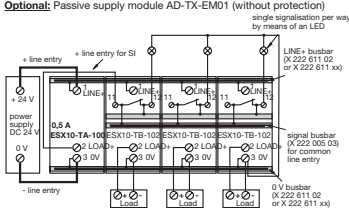

Mounting examples for ESX10-T

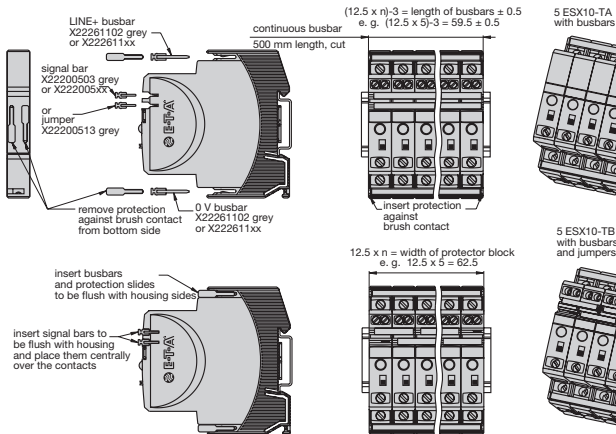

Mounting procedure:

Before wiring insert busbars into protector block.
Max. 10 insertion/removal cycles for busbars.

Recommendation:

After 10 units the busbars and signal busbars should be interrupted and receive a new entry live

Table of lengths for busbars

(X 222 611 02 / X 222 005 03 or cut off, see accessories)

No. of units	2	3	4	5	6	7	8	9	10
Length of busbar (mm) ± 0.5 mm	22	34.5	47	59.5	72	84.5	97	109.5	122

3 Informationen on UL-approvals/ CSA-approvals

 **ESX10-TA / -TB**
UL2367
Non-hazardous use
UL File # E306740

 **UL 508**
Non-hazardous use
UL File # E322549

 **E322549**
INDUSTRIAL CONTROL EQUIPMENT

 **ESX10-TA / -TB**
ISA 12.12.01-2015
UL File # E320024

Operating Temperature Code T4

- This equipment is suitable for use in Class I, Division 2, Groups A, B, C and D or non-hazardous locations only. T4 A / 0 °C to 50 °C

WARNING:

- Exposure to some chemicals may degrade the sealing properties of materials used in the following device: relay (K1)

Sealant Material:

Generic Name: Modified diglycidyl ether of bisphenol A
Supplier: Fine Polymers Corporation

Type: Epi Fine 4616L-160PK

Casing Material:

Generic Name: Liquid Crystal Polymer

Supplier: Sumitomo Chemical

Type: E4008, E4009, or E6008

RECOMMENDATION:

- Periodically inspect the device named above for any degradation of properties and replace if degradation is found

WARNING – EXPLOSION HAZARD:

AVERTISSEMENT – RISQUE D'EXPLOSION

- Do not disconnect equipment unless power has been removed or the area is known to be non-hazardous.
- Avant de déconnecter l'équipement, couper le courant ou s'assurer que l'emplacement est désigné non dangereux.
- Substitution of any components may impair suitability for Class I, Division 2.

La substitution de composants peut rendre ce matériel inacceptable pour les emplacements de class I, division 2.

This device is OPEN type equipment that must be used within a suitable end-use system enclosure, the interior of which is accessible only through the use of a tool. The suitability of the enclosure is subject to investigation by the local Authority Having Jurisdiction at the time of installation.

Wiring to or from this device, which enters or leaves the system enclosure, must utilize wiring methods suitable for Class I, Division 2 Hazardous Locations, as appropriate for the installation.

 **ESX10-TA / -TB**
CSA C22.2 No. 14 - File # 016186
CSA C22.2 No. 142 - File # 016186
CSA C22.2 No. 213
(Class I, Division 2) - File # 016186

Class 2

Meets requirement for Class 2 current limitation
(ESX10-T...-0.5 A / 1 A / 2 A / 3 A)

4 Accessories

4.1 Description

The ESX10-T features an integral power distribution system. The following wiring modes are possible with various pluggable current and signal busbars:

- LINE +(DC 24 V)
- 0 V
- **Caution:** The electronic devices ESX10-T require a 0 V connection
- signal contacts
- reset inputs

4.2 Accessories

Use original E-T-A accessories only!

- **Busbars for LINE+ and 0 V**
max. load with one line entry (recommended: centre line entry)
max. load with two line entries
grey insulation, length: 500 mm
X 222 611 02
- **Busbars for LINE+ and 0 V**
grey insulation
max. number of plug-on operations 10:

X 222 611 22
(2-unit-block ESX10-T), length: 22 mm

X 222 611 34
(3-unit-block ESX10-T), length: 34.5 mm

X 222 611 47
(4-unit-block ESX10-T), length: 47 mm

X 222 611 59
(5-unit-block ESX10-T), length: 59.5 mm

X 222 611 72
(6-unit-block ESX10-T), length: 72 mm

X 222 611 97
(8-unit-block ESX10-T), length: 97 mm

X 222 611 12
(10-unit-block ESX10-T), length: 122 mm

- **Signal busbars for signal contacts and reset inputs**
suitable for signal busbar ESX10-TB-...
max. load with one line entry
with one series connection of signal contacts I_{max}
grey insulation, length: 500 mm
X 222 005 03
- **Jumpers for signal contacts**
suitable for jumper ESX10-TB-...
grey insulation, length: 21 mm
X 222 005 13

- **Insulated wire bridge**
optional as jumper for ESX10-TB-101...
for group signalisation (series connection)
X 223 108 01

- **Connector bus link -K10**
suitable for auxiliary contacts (series connection)
X 210 589 02 (1.5 mm², brown)

EU-Konformitätserklärung Nr. 100.218.1018-04
Declaration of Conformity

Wir **E-T-A Elektrotechnische Apparate GmbH**
We **Industriestraße 2-8, D-90518 Alldorf, Germany**

(Name und Anschrift des Anbieters / supplier's name and address)

erklären in alleiniger Verantwortung, dass das Produkt
declare under our sole responsibility that the product

Elektronischer Sicherungsautomat
Solid state overcurrent protector

ESX10-TA (Hutschienmontage 24Vdc / rail mounting 24Vdc)

ESX10-TB (Hutschienmontage 24Vdc / rail mounting 24Vdc)

ESX10-... (Steckmontage, mit Modul 17PLUS, 24Vdc / plug-in mounting with module 17PLUS, 24Vdc)

ESX10-TC (Hutschienmontage 12Vdc / rail mounting 12Vdc)
(Bezeichnung, Typ/Modell, evtl. Spezifikation/ name, type/model, optionally specification)

Diese
Konformitätserklärung
folgt den grundlegenden
Anforderungen der Norm
EN ISO/IEC 17050-
1:2010

Konformitätsbewertung -
Konformitätserklärung
von Anbietern – Teil 1:
Allgemeine
Anforderungen.

This Declaration of
Conformity is following
the basic requirements of
the standard EN ISO/IEC
17050-1:2010
Conformity assessment -
Supplier's declaration of
conformity – Part 1:
General requirements.

auf das sich diese Erklärung bezieht, mit den wesentlichen
Anforderungen folgender Richtlinie(n) übereinstimmt.
to which the declaration relates, is in conformity with the essential requirements of following
Directive(s)

2014/34/EU ATEX-Richtlinie / ATEX Directive

Zur Beurteilung der Übereinstimmung wurde(n) folgende Norm(en)
oder normative Dokumente herangezogen:

For evaluation of the conformity following standard(s) or normative document(s) were
consulted:

EN 60079-0:2012 +A11:2013

Explosionsgefährdete Bereiche - Teil 0: Betriebsmittel - Allgemeine
Anforderungen

Explosive atmospheres - Part 0: Equipment - General requirements

EN 60079-15: 2010 - Explosive Atmosphäre – Geräteschutz durch
Zündschutzart „n“

Explosive atmospheres – Equipment protection by type of protection "n"

(Titel und/oder Nr. sowie Ausgabedatum der Norm(en) oder der anderen norma-
tiven Dokumente / Title and/or number and date of issue of the standard(s) or other
normative document(s))

EU-Konformitätserklärung Nr. 100.218.1018-04
Declaration of Conformity

Zusätzliche Angaben: Additional information:

II 3G Ex nA IIB T4 Gc X
-20°C ≤ T_{as} ≤ +80°C (für / for ESX10-TC)
0°C ≤ T_{as} ≤ +50°C (für / for ESX10, ESX10-TA, ESX10-TB)

Besondere Bedingungen: Special conditions:

Die zugehörige Betriebsanleitung enthält wichtige sicherheitstechnische Hinweise und Vorschriften für die Inbetriebnahme der genannten Geräte gemäß der Richtlinie 2014/34/EU (ATEX).
The pertinent user manual is including important safety-related information and regulations for placing into operation of the described devices in accordance with Directive 2014/34/EU (ATEX).

Werden die Produkte in eine übergeordnete Maschine/Anlage eingebaut, so müssen die durch den Einbau entstehenden neuen Risiken durch den Hersteller der neuen Maschine/Anlage beurteilt werden.

In case the products will be fitted into a higher-level machine or system, the manufacturer of the new machine or system needs to assess possible new risks resulting from this action.

Altdorf, 12. April 2017

Dr. Clifford Sell
Geschäftsführer

Ralf Dietrich
Ltg. Produkt-, Marktentwicklung

(Ort und Datum der Ausstellung / Place and date of issue)

(Name, Funktion, Unterschrift des/der Befugten / name, function, signature of authorized person(s))

D-90618 Altdorf bei Nürnberg • Germany • Telephone +49 9187 / 10-0 • Facsimile +49 9187 / 10-398

All dimensions without tolerances are for reference only. In the interest of improved design, performance and cost effectiveness the right to make changes in these specifications without notice is reserved. Product markings may not be exactly as the ordering codes. Errors and omissions excepted.



<http://www.e-t-a.de/qr1006/>

Bedienungsanleitung ESX10-TA/TB--E (D/E)
Bestell-Nr. / Ref. number Y31040901 Index: b
Ausgabe / Issue: 10/2017 / Alle Rechte vorbehalten / All rights reserved