

**NOT RECOMMENDED FOR NEW DESIGNS
USE ER1A-LTP~ER1J-LTP SERIES**



Micro Commercial Components

Micro Commercial Components
20736 Marilla Street Chatsworth
CA 91311
Phone: (818) 701-4933
Fax: (818) 701-4939

**ER1A
THRU
ER1M**

Features

- Easy Pick And Place
- High Temp Soldering: 260°C for 10 Seconds At Terminals
- Ultrafast Recovery Times For High Efficiency
- Lead Free Finish/Rohs Compliant (Note1) ("P" Suffix designates Compliant. See ordering information)
- Halogen free available upon request by adding suffix "-HF"
- Epoxy meets UL 94 V-0 flammability rating
- Moisture Sensitivity Level 1

Maximum Ratings

- Operating Temperature(Tj): -50°C to +150°C
- Storage Temperature(Tstg): -50°C to +150°C
- Maximum Thermal Resistance; 15°C/W Junction To Lead

MCC Catalog Number	Device Marking	Maximum Recurrent Peak Reverse Voltage	Maximum RMS Voltage	Maximum DC Blocking Voltage
ER1A	ER1A	50V	35V	50V
ER1B	ER1B	100V	70V	100V
ER1C	ER1C	150V	105V	150V
ER1D	ER1D	200V	140V	200V
ER1G	ER1G	400V	280V	400V
ER1J	ER1J	600V	420V	600V
ER1K	ER1K	800V	560V	800V
ER1M	ER1M	1000V	700V	1000V

**1 Amp Ultra Fast
Recovery
Silicon Rectifier
50 to 1000 Volts**

**DO-214AA
(HSMB) (Round Lead)**

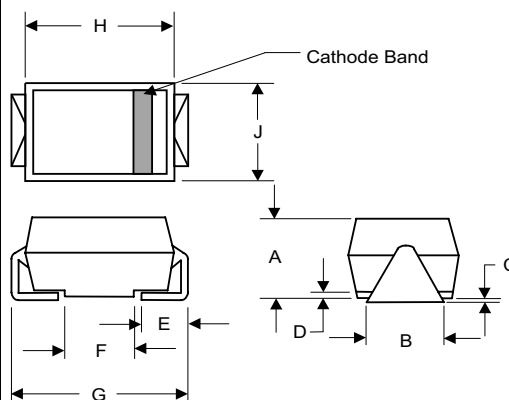

Electrical Characteristics @ 25°C Unless Otherwise Specified

Average Forward Current	$I_{F(AV)}$	1.0A	$T_J = 75^\circ\text{C}$
Peak Forward Surge Current	I_{FSM}	30A	8.3ms, half sine
Maximum Instantaneous Forward Voltage	V_F	.975V 1.35V 1.70V	$I_{FM} = 1.0A;$ $T_J = 25^\circ\text{C}^*$
Maximum DC Reverse Current At Rated DC Blocking Voltage	I_R	5μA 100μA	$T_J = 25^\circ\text{C}$ $T_J = 100^\circ\text{C}$
Maximum Reverse Recovery Time	T_{rr}	50ns 75ns 100ns	$I_F=0.5A, I_R=1.0A,$ $I_{rr}=0.25A$
Typical Junction Capacitance	C_J	45pF	Measured at 1.0MHz, $V_R=4.0V$

DIM	DIMENSIONS				NOTE
	INCHES		MM		
A	.078	.116	1.98	2.95	
B	.075	.089	1.90	2.25	
C	.002	.008	.05	.20	
D	----	.02	----	.51	
E	.035	.055	.90	1.40	
F	.065	.091	1.65	2.32	
G	.205	.224	5.21	5.69	
H	.160	.180	4.06	4.57	
J	.130	.155	3.30	3.94	

**SUGGESTED SOLDER
PAD LAYOUT**

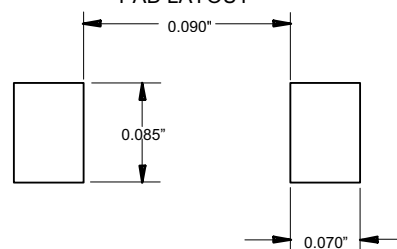

*Pulse test: Pulse width 200usec, Duty cycle 2%

Note: 1. High Temperature Solder Exemptions Applied, see EU Directive Annex 7.

ER1A thru ER1M

Figure 1
Typical Forward Characteristics

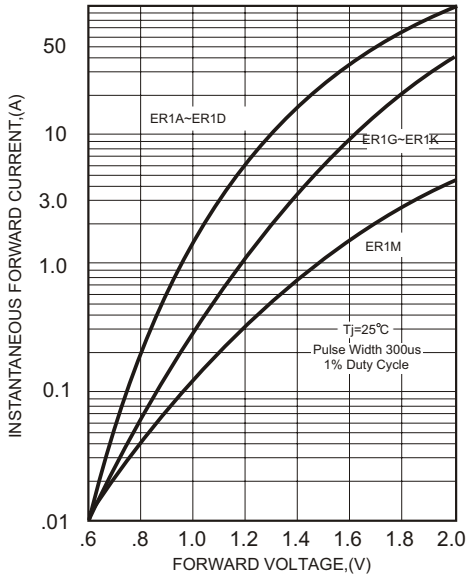

Instantaneous Forward Current - Amperes versus Instantaneous Forward Voltage - Volts

Figure 2
Forward Derating Curve

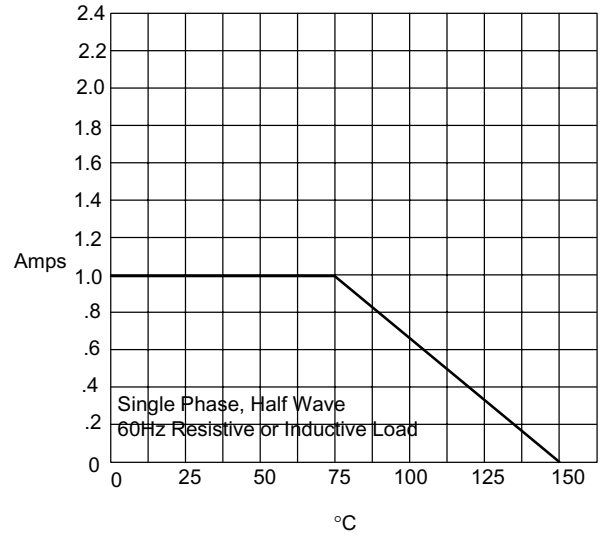

Average Forward Rectified Current - Amperes versus Ambient Temperature - °C

Figure 3
Junction Capacitance

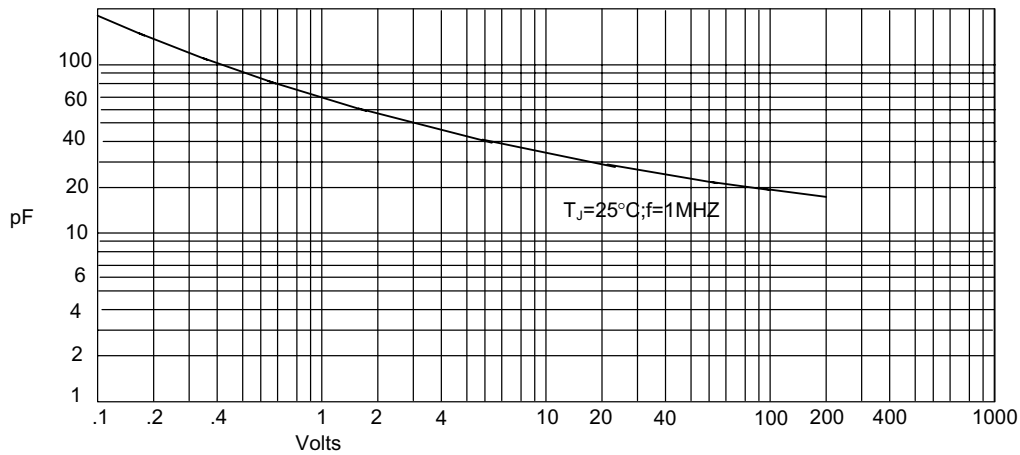

Junction Capacitance - pF versus Reverse Voltage - Volts

ER1A thru ER1M

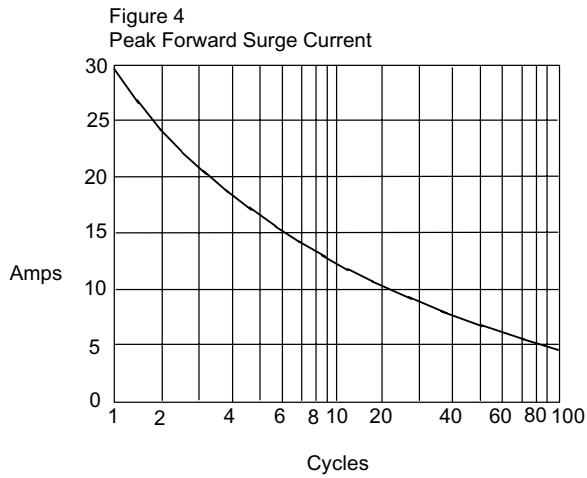

Peak Forward Surge Current - Amperes *versus* Number Of Cycles At 60Hz - Cycles

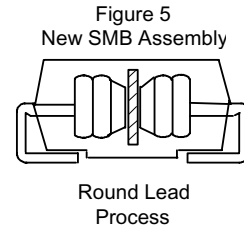
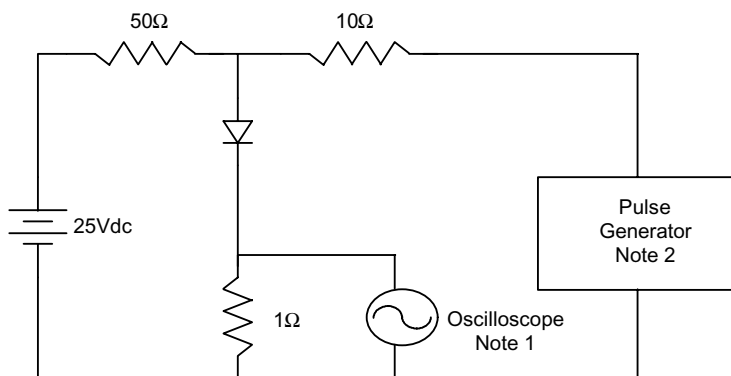
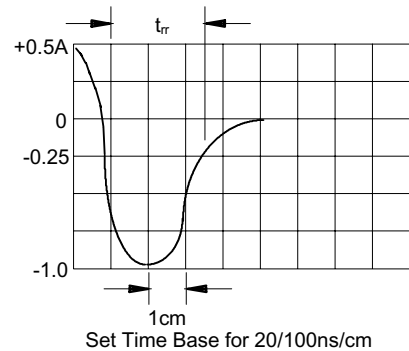

Figure 6
Reverse Recovery Time Characteristic And Test Circuit Diagram



- Notes:
1. Rise Time = 7ns max.
Input impedance = 1 megohm, 22pF
 2. Rise Time = 10ns max.
Source impedance = 50 ohms
 3. Resistors are non-inductive





TM

Micro Commercial Components

Ordering Information :

Device	Packing
Part Number-TP	Tape&Reel: 3Kpcs/Reel

Note : Adding "-HF" suffix for halogen free, eg. Part Number-TP-HF

IMPORTANT NOTICE

Micro Commercial Components Corp. reserves the right to make changes without further notice to any product herein to make corrections, modifications , enhancements , improvements , or other changes . **Micro Commercial Components Corp .** does not assume any liability arising out of the application or use of any product described herein; neither does it convey any license under its patent rights ,nor the rights of others . The user of products in such applications shall assume all risks of such use and will agree to hold **Micro Commercial Components Corp .** and all the companies whose products are represented on our website, harmless against all damages.

LIFE SUPPORT

MCC's products are not authorized for use as critical components in life support devices or systems without the express written approval of Micro Commercial Components Corporation.

CUSTOMER AWARENESS

Counterfeiting of semiconductor parts is a growing problem in the industry. Micro Commercial Components (MCC) is taking strong measures to protect ourselves and our customers from the proliferation of counterfeit parts. MCC strongly encourages customers to purchase MCC parts either directly from MCC or from Authorized MCC Distributors who are listed by country on our web page cited below. Products customers buy either from MCC directly or from Authorized MCC Distributors are genuine parts, have full traceability, meet MCC's quality standards for handling and storage. **MCC will not provide any warranty coverage or other assistance for parts bought from Unauthorized Sources.** MCC is committed to combat this global problem and encourage our customers to do their part in stopping this practice by buying direct or from authorized distributors.

www.mccsemi.com