

DWG. NO. SD-54432-004

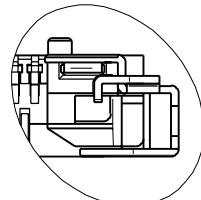

詳細 B
DETAIL B
(SCALE:5-1)

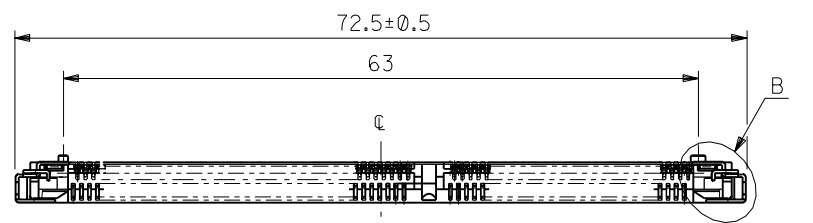
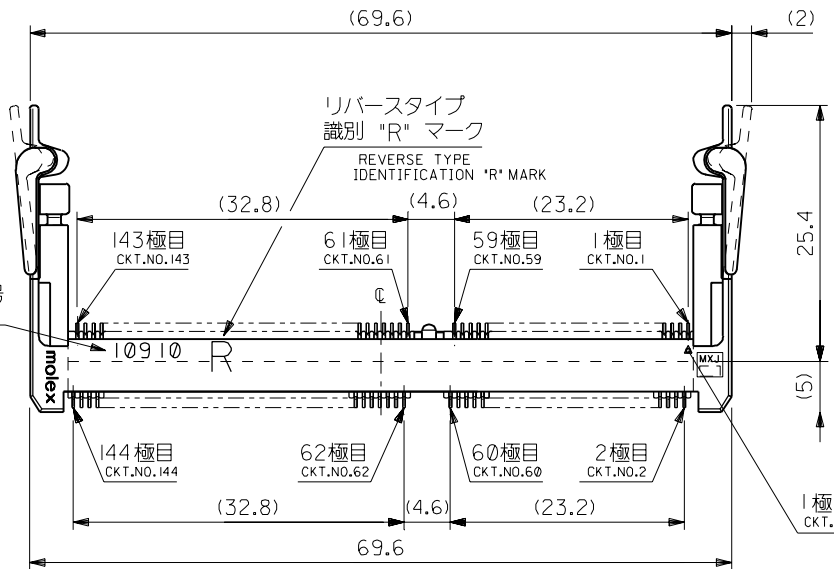

ロット番号
LOT No.

ネイル
NAIL

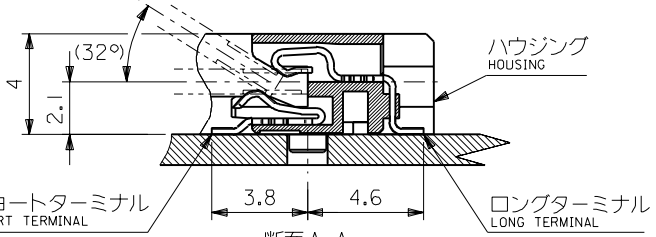
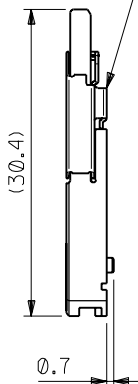

断面 A-A
SECTION A-A
(SCALE:5-1)

注記 NOTES

1. 材料 MATERIAL
ハウジング : ガラス入り耐熱樹脂、白色、UL94V-0
HOUSING : G.F.HEAT RESISTANT PLASTIC, WHITE, UL94V-0
ターミナル : 燐青銅
TERMINAL : PHOSPHOR BRONZE
ネイル : 黄銅
NAIL : BRASS

2. めっき仕様 PLATING
ロングターミナル LONG TERMINAL
接点部 : 金めっき 0.25µmMIN.
CONTACT AREA : GOLD 0.25 µmMIN.
半田付け部 : 半田めっき 1.0µmMIN.
SOLDER TAIL AREA : TIN-LEAD 1.0µmMIN.
下地めっき : ニッケルめっき 2.0µmMIN.
UNDER-PLATING : NICKEL 2.0µmMIN.
ショートターミナル SHORT TERMINAL
接点部 : 金めっき 0.25µmMIN.
CONTACT AREA : GOLD 0.25 µmMIN.
半田付け部 : 金めっき 0.3µmMAX.
SOLDER TAIL AREA : GOLD 0.3µmMAX.
下地めっき : ニッケルめっき 2.0µmMIN.
UNDER-PLATING : NICKEL 2.0µmMIN.
ネイル NAIL
半田めっき : 2.0µmMIN.
TIN-LEAD : 2.0µmMIN.

3. テール平坦度は、0.1 MAX. とする。
TAIL COPLANARITY TO BE 0.1 MAX.
ネイル平坦度は、0.1 MAX. とする。
NAIL COPLANARITY TO BE 0.1 MAX.

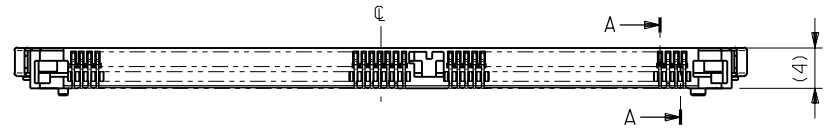

1.75	2.85	1.35	3.25	4.05	***V	標準トレイ NORMAL TRAY	54432-1442	54432-144*
3.25	1.35	2.85	1.75	5.55	5.0V	標準トレイ NORMAL TRAY	54432-1441	
2.5	2.1	2.1	2.5	4.8	3.3V	ハードトレイ (高さ9) HARD TRAY(HIGHT 9)	54432-1446	
						ハードトレイ (高さ11) HARD TRAY(HIGHT 11)	54432-1443	
						標準トレイ NORMAL TRAY	54432-1440	
E	D	C	B	A	POWER SUPPLY	梱包トレイ PACKAGING TRAY	MATERIAL NO.	MODEL NO.

DO NOT SCALE DRAWING

EC NO. DRWN: CHK'K: APPR:	EC NO. DRWN: CHK'K: APPR:	REVISED EC NO. J2002-0547 DRWN: T.KANEKO CHK'K: Y.IITO APPR: H.IKESUGI	REVISED EC NO. JD91395 DRWN: T.KANEKO CHK'K: Y.IITO APPR: H.IKESUGI	RELEASED EC NO. JD81667 DRWN: T.KANEKO CHK'K: Y.IITO APPR: H.IKESUGI	DESCRIPTION	MATERIAL 材料
					注記参照 SEE NOTES	注記参照 SEE NOTES
					FINISH 仕上げ	
					WIRE RANGE 適用線径範囲	
					INS. RANGE 被覆外径	

GENERAL TOLERANCES: (UNLESS SPECIFIED) 一般公差		SCALE 2-1	DESIGN UNITS mm □ INCH	THIRD ANGLE PROJECTION
10 UNDER 未満	±0.2	DRAWN BY & DATE T.Kanebo '98/06/04		TITLE: 0.8mm PITCH S.O.DIMM SOCKET REVERSE TYPE H=4mm
10 OVER 以上	±0.25	CHECKED BY & DATE Y.Ota '98/06/04		
30 OVER 以上	±0.3	APPROVED BY & DATE H.Ikessugi '98/06/04		
ANGLE 角度	±3°	CAD FILE NAME 54432004.S01	MATERIAL NO. SEE CHART	DRAWING NO. SD-54432-004

DIMENSIONS: <input type="checkbox"/> mm <input type="checkbox"/> INCH <input checked="" type="checkbox"/> mm ONLY		SHT	REV
REVISION ON CAD ONLY			
MATERIAL NO. DRAWING NO. SHEET NO. SEE CHART SD-54432-004 1 OF 3			
THIS DRAWING CONTAINS INFORMATION THAT IS PROPRIETARY TO MOLEX INCORPORATED AND SHOULD NOT BE USED WITHOUT WRITTEN PERMISSION.			
			SIZE B

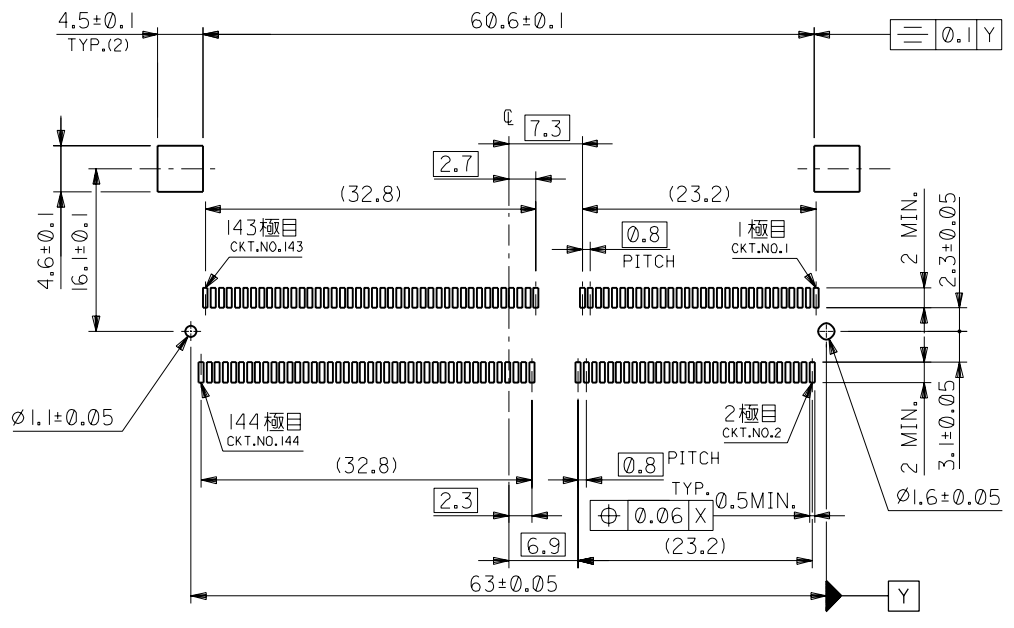

推奨基板寸法
RECOMMENDED PCB PATTERN LAYOUT
(THK:1.2±0.1)

DO NOT SCALE DRAWING

EC NO. DRWN: CHK: APPR:		EC NO. DRWN: CHK: APPR:		EC NO. DRWN: CHK: APPR:		EC NO. DRWN: CHK: APPR:		EC NO. DRWN: CHK: APPR:		EC NO. DRWN: CHK: APPR:		MATERIAL 材料 注記参照 SEE NOTES		GENERAL TOLERANCES: (UNLESS SPECIFIED) 一般公差		SCALE 2-1		DESIGN UNITS mm INCH		THIRD ANGLE PROJECTION		DIMENSIONS: <input type="checkbox"/> mm <input type="checkbox"/> INCH <input checked="" type="checkbox"/> mm ONLY		SHT REV			
								SEE 1 OF 3		FINISH 仕上げ 注記参照 SEE NOTES		10 UNDER 未満		±0.2		DRAWN BY & DATE <i>J. Harber</i> '98/06/04		TITLE: 0.8mm PITCH S.O.DIMM SOCKET REVERSE TYPE H=4mm				REVISE ON CAD ONLY					
										WIRE RANGE 適用電線範囲		10 OVER 以上		30 UNDER 未満		±0.25		CHECKED BY & DATE <i>Y. Ota</i> '98/06/04		MOLEX INCORPORATED							
										INS. RANGE 被覆外径		30 OVER 以上				±0.3		APPROVED BY & DATE <i>Y. Ota</i> '98/06/04									
												ANGLE 角度				±3°		CAD FILENAME 54432004.S02		MATERIAL NO. SEE CHART		DRAWING NO. SD-54432-004		SHEET NO. 2 OF 3			
																								THIS DRAWING CONTAINS INFORMATION THAT IS PROPRIETARY TO MOLEX INCORPORATED AND SHOULD NOT BE USED WITHOUT WRITTEN PERMISSION.		SIZE B	

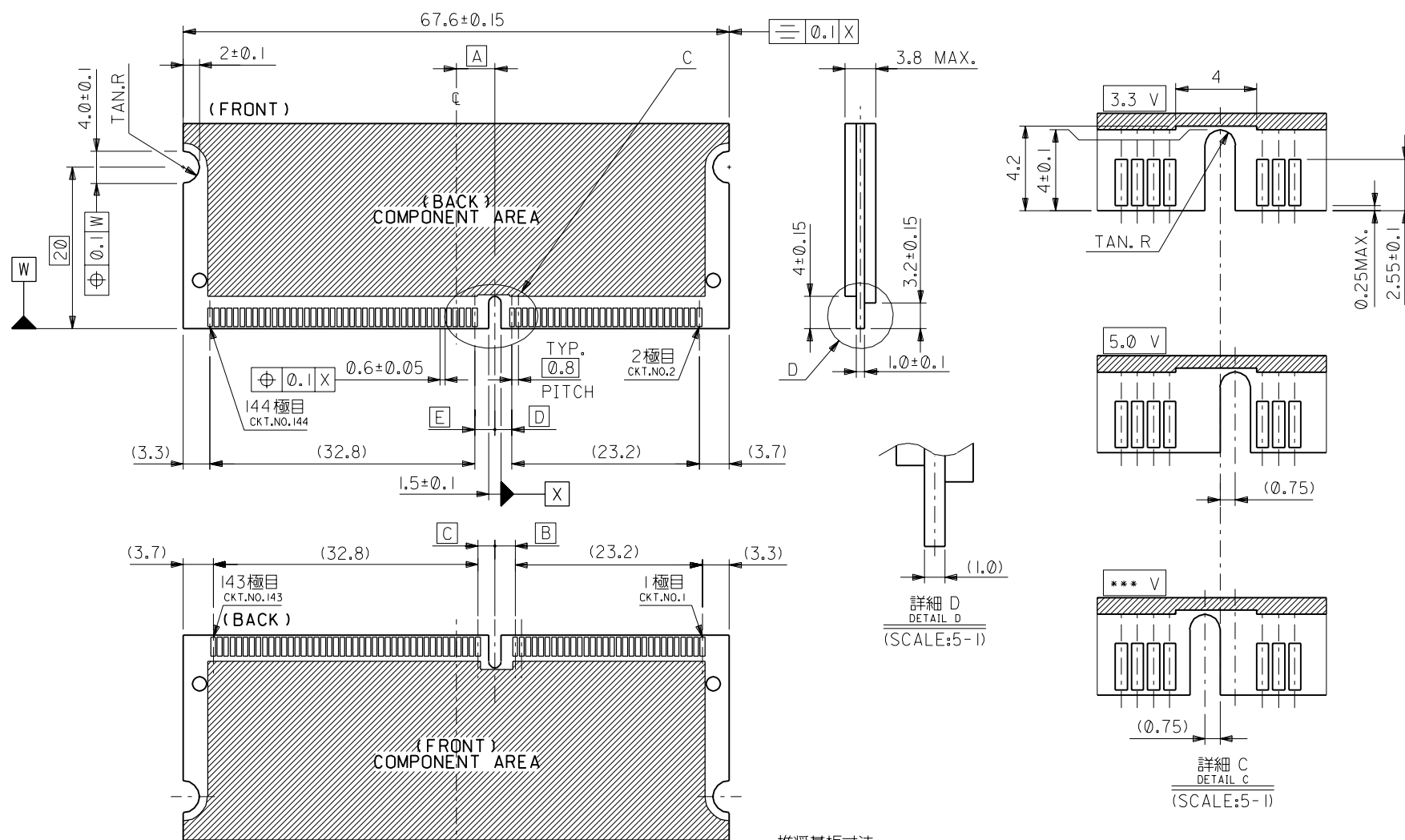

推奨基板寸法
RECOMMENDED MATING BOARD CONFIGURATION
(THK:1.0±0.1)

DO NOT SCALE DRAWING

EC NO. DRWN: CHK'g APPR'g	EC NO. DRWN: CHK'g APPR'g	EC NO. DRWN: CHK'g APPR'g	EC NO. DRWN: CHK'g APPR'g	EC NO. DRWN: CHK'g APPR'g	EC NO. DRWN: CHK'g APPR'g	DESCRIPTION	MATERIAL 材料	GENERAL TOLERANCES: (UNLESS SPECIFIED) 一般公差	SCALE 2-1	DESIGN UNITS mm INCH	THIRD ANGLE PROJECTION	DIMENSIONS:		SHT	REV
							注記参照 SEE NOTES					mm INCH	mm ONLY		
B	A	0	SEE 1 OF 3				FINISH 仕上げ	10 UNDER 未満	±0.2	DRAWN BY & DATE <i>J. Harada</i> '98/06/04	TITLE: 0.8mm PITCH S.O.DIMM SOCKET REVERSE TYPE H=4mm				
							注記参照 SEE NOTES	10 OVER 30 UNDER 以上 未満	±0.25	CHECKED BY & DATE <i>Y. Ota</i> '98/06/04	MATERIAL NO. DRAWING NO. SHEET NO.				
							WIRE RANGE 適用電線範囲	30 OVER 以上	±0.3	APPROVED BY & DATE <i>Y. Ota</i> '98/06/04		MOLEX INCORPORATED			
							INS. RANGE 被覆外径		ANGLE 角度	±3°	CAD FILENAME 54432004.S03	SEE CHART	SD-54432-004	3 OF 3	
THIS DRAWING CONTAINS INFORMATION THAT IS PROPRIETARY TO MOLEX INCORPORATED AND SHOULD NOT BE USED WITHOUT WRITTEN PERMISSION.												SIZE B			