

OLED B click™

1. Introduction

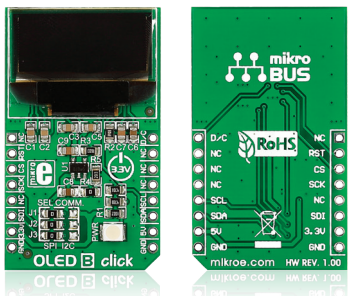

OLED B click™ lets you add a small but bright and crisp display to your design. It carries a blue monochrome passive matrix OLED display and a **SSD1306** IC to control it. OLED B click™ can communicate with the target board either through SPI or I²C interfaces. **mikroBUS™** lines used for SPI are CS, SCK, and MOSI (SDI); I²C output uses SCL and SDA lines; also, both modes use PWM (A/C) and RST lines. You select between SPI and I²C outputs by resoldering three jumpers. OLED B click™ uses a 3.3V power supply.

2. Soldering the headers

Before using your click™ board, make sure to solder 1x8 male headers to both left and right side of the board. Two 1x8 male headers are included with the board in the package.

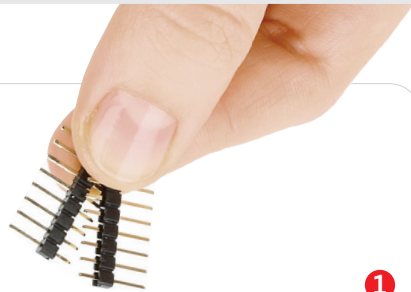

1

2

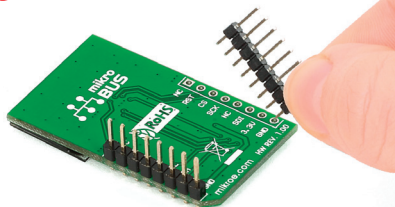

Turn the board upside down so that the bottom side is facing you upwards. Place shorter pins of the header into the appropriate soldering pads.

3

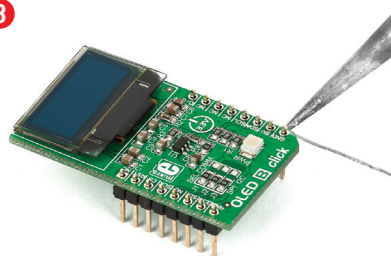

Turn the board upward again. Make sure to align the headers so that they are perpendicular to the board, then solder the pins carefully.

3. Plugging the board in

Once you have soldered the headers your board is ready to be placed into the desired mikroBUS™ socket. Make sure to align the cut in the lower-right part of the board with the markings on the silkscreen at the mikroBUS™ socket. If all the pins are aligned correctly, push the board all the way into the socket.

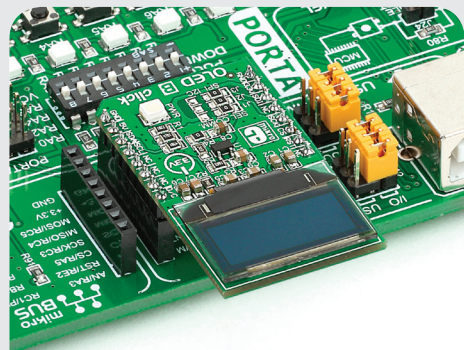
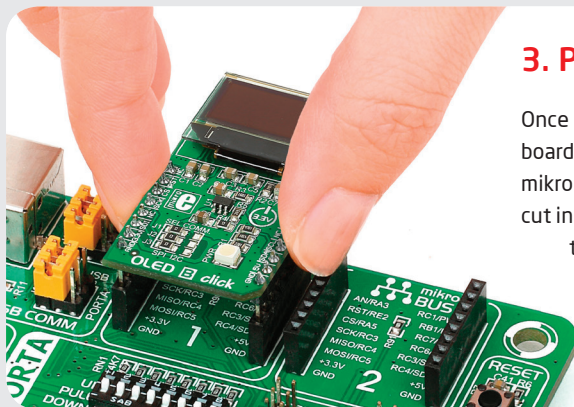

4. Essential features

OLED displays are made from a thin film of organic compound that emits light when exposed to a current. Small monochrome displays like these are ideal for displaying text or icons. They are bright, have a wide viewing angle and low power consumption. The display on OLED B click™ is 19.3 x 7.8mm with a 96 x 39px resolution. The SSD1306 controller has built-in functionalities like contrast control, normal or inverse image display, vertical and horizontal scrolling functions and many more.

click™
BOARD
www.mikroe.com



OLED B click Manual v100



0 100000 027080

5. OLED B click™ board schematic

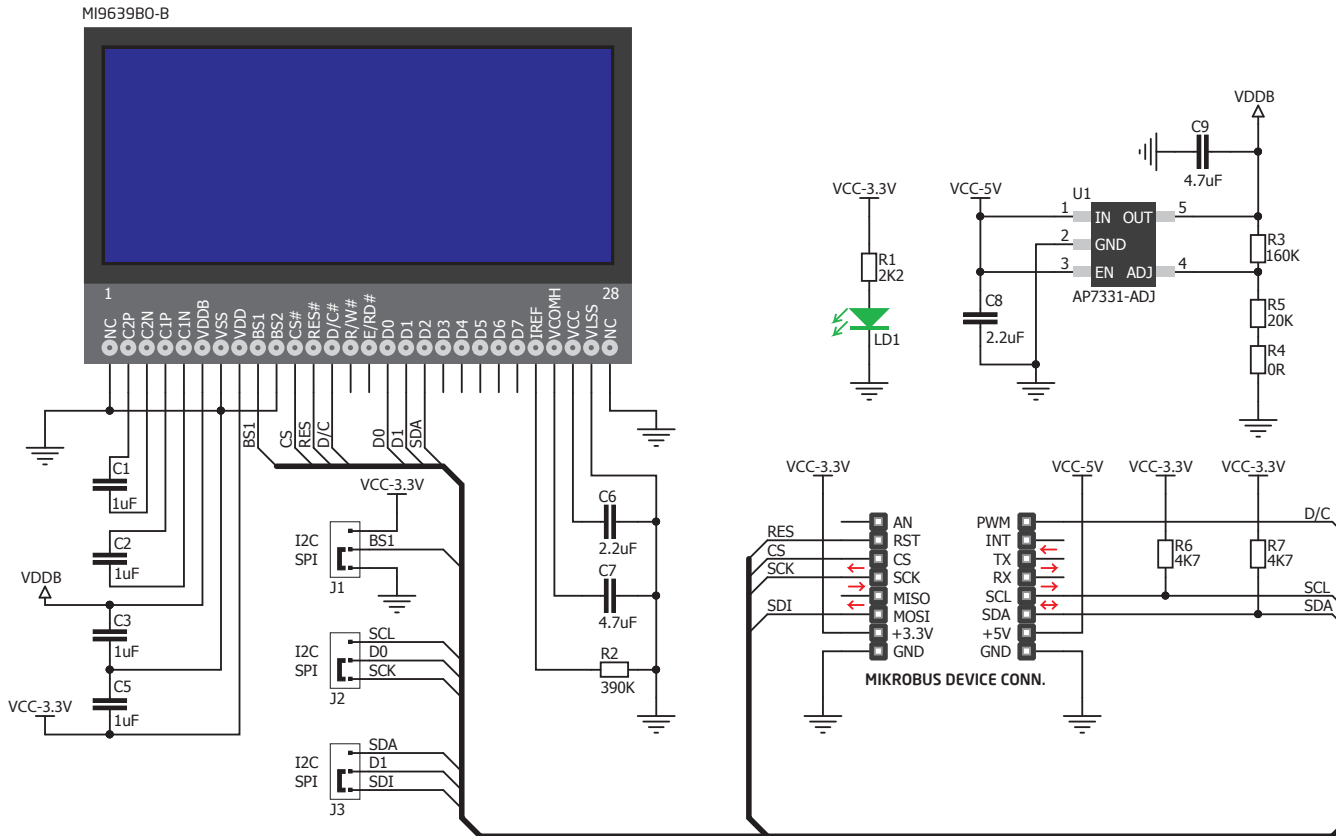

6. Interface selection

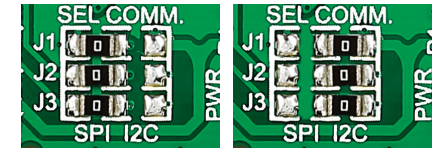

To switch from SPI to I²C output on OLED B click, resolder all three onboard jumpers (**J1**, **J2** and **J3**) to the I²C position.

7. Code examples

Once you have done all the necessary preparations, it's time to get your click™ board up and running. We have provided examples for mikroC™, mikroBasic™ and mikroPascal™ compilers on our **Libstock** website. Just download them and you are ready to start.



8. Support

MikroElektronika offers **free tech support** (www.mikroe.com/support) until the end of the product's lifetime, so if something goes wrong, we're ready and willing to help!