

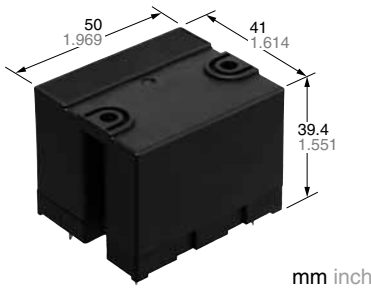

Max. 1,000 V DC, 20 A cut-off possible
High capacity power relays

HE-V RELAYS



RoHS compliant

Protective construction: Flux-resistant type

FEATURES

- Compact size**
(L: 41.0 × W: 50.0 × H: 39.4 mm)
L: 1.614 × W: 1.969 × H: 1.551 inch)
 Maximum 1,000 V DC, 20 A cut-off has been achieved (at each 1 Form A contact connected in series)

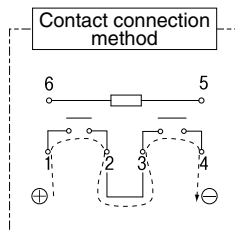

- Contact arrangement: 2 Form A**
 400 V DC, 20 A per 1 Form A
- Contributes to energy saving in devices thanks to reduced coil hold voltage**
 Coil hold voltage can be reduced down to 33% of the nominal coil voltage. This equals to operating power of approximately 210 mW.
 *Coil hold voltage is the coil voltage after 100 ms following application of the nominal coil voltage.

TYPICAL APPLICATIONS

- Photovoltaic power generation systems (PV inverters, PV combiners)**
 • Suitable for NEC 2014 section 690.12 Rapid shut down
- Battery charge and discharge systems**
- Inverter control, DC load control, etc.**

ORDERING INFORMATION

HEV **2a** **N** - **P** - DC

Contact arrangement
 2a: 2 Form A (Single side stable type)

Pick-up voltage
 N: 70% of nominal voltage

Terminals
 P: PC board terminal type

Coil voltage (DC)
 6V, 9V, 12V, 15V, 24V

TYPES

Nominal coil voltage	Part No.
6V DC	HEV2aN-P-DC6V
9V DC	HEV2aN-P-DC9V
12V DC	HEV2aN-P-DC12V
15V DC	HEV2aN-P-DC15V
24V DC	HEV2aN-P-DC24V

Standard packing: Carton: 10 pcs.; Case: 50 pcs.

RATING

1. Coil data

Nominal coil voltage	Pick-up voltage (at 20°C 68°F) (Initial)	Drop-out voltage (at 20°C 68°F) (Initial)	Nominal operating current [±10%] (at 20°C 68°F)	Coil resistance [±10%] (at 20°C 68°F)	Nominal operating power	Max. applied voltage (at 55°C 131°F)
6V DC	70%V or less of nominal voltage	5%V or more of nominal voltage	320mA	18.8Ω	1,920mW	110%V of nominal voltage
9V DC			213mA	42.2Ω		
12V DC			160mA	75.0Ω		
15V DC			128mA	117.0Ω		
24V DC			80mA	300.0Ω		

2. Specifications

Characteristics	Item	Specifications	
Contact	Arrangement	2 Form A	
	Contact material	AgNi type	
	Contact resistance (Initial)	Max. 100 mΩ (By voltage drop 6 V DC 1 A), Max. 3 mΩ (By voltage drop 6 V DC 20 A, Reference value)	
Rating	Contact rating (Resistive load)	20 A 800 V DC, 25 A 600 V DC (at each 1 Form A contact connected in series), 20 A 400 VDC (at 1 Form A contact only)	
	Max. switching voltage	1,000 V DC	
	Max. switching current	25 A	
	Min. switching capacity (Reference value)*1	100 mA 5 V DC	
Electrical characteristics	Insulation resistance (Initial)	Min. 1,000MΩ (at 1,000V DC) Measurement at same location as "Breakdown voltage" section.	
	Short current (Initial)	Max. 300 A 1 ms (Reference value)	
	Breakdown voltage (Initial)	Between open contacts	2,000 Vrms for 1 min. (Detection current: 10 mA)
		Between contact sets	4,000 Vrms for 1 min. (Detection current: 10 mA)
		Between contact and coil	5,000 Vrms for 1 min. (Detection current: 10 mA)
	Surge breakdown voltage*2 (Between contact and coil) (Initial)	Min. 10,000 V	
	Coil holding voltage*3	33 to 110%V (Contact carrying current: 20A, at 55°C 131°F), 33 to 60%V (Contact carrying current: 20A, at 85°C 185°F)	
	Operate time (at 20°C 68°F)	Max. 30 ms (nominal coil voltage, without bounce)	
Release time (at 20°C 68°F)	Max. 10 ms (nominal coil voltage) (without diode)		
Mechanical characteristics	Shock resistance	Functional	Min. 98 m/s ² (Half-wave pulse of sine wave: 11 ms; detection time: 10 μs)
		Destructive	Min. 980 m/s ² (Half-wave pulse of sine wave: 6 ms)
	Vibration resistance	Functional	10 to 55 Hz at double amplitude of 1.0 mm (Detection time: 10 μs)
		Destructive	10 to 55 Hz at double amplitude of 1.5 mm
Expected life	Mechanical life	Min. 10 ⁶ (at 180 cpm)	
Conditions	Conditions for operation, transport and storage*4	Ambient temperature: -40 to +55°C -40 to +131°F (When coil holding voltage is 33% to 110% of nominal coil voltage) -40 to +85°C -40 to +185°F (When applied coil hold voltage is 33% to 60% of nominal coil voltage) Humidity: 5 to 85% R.H. (Not freezing and condensing)	
Unit weight		Approx. 120 g 4.23 oz	

Notes: *1. This value can change due to the switching frequency, environmental conditions, and desired reliability level, therefore it is recommended to check this with the actual load.

*2. Wave is standard shock voltage of ±1.2×50μs according to JEC-212-1981

*3. Coil holding voltage is the coil voltage after 100 ms following application of the nominal coil voltage.

*4. The upper operation ambient temperature limit is the maximum temperature that can satisfy the coil temperature rise value. Refer to Usage, transport and storage conditions in NOTES.

3. Expected electrical life

1. Each 1 Form A contact connected in series

Conditions: Ambient temperature: 20°C 68°F (L/R 1 ms), ON : OFF = 1 s : 9s

Load	Switching capacity	Number of operations
Resistive	20A 600V DC	Min. 1×10 ⁴
	20A 800V DC	Min. 1×10 ³
	25A 600V DC	Min. 6×10 ³
Overload	20A 1,000V DC	Min. 1×10
Reverse	-20A 400V DC	Min. 1×10 ³
Inrush current	40A 800V DC	Min. 1×10 ³

2. 1 Form A contact only

Conditions: Ambient temperature: 20°C 68°F (L/R 1 ms), ON : OFF = 1 s : 9s

Load	Switching capacity	Number of operations
Resistive	20A 300V DC	Min. 1×10 ⁴
	20A 400V DC	Min. 1×10 ³
Overload	20A 500V DC	Min. 1×10
Reverse	-20A 200V DC	Min. 1×10 ³
Inrush current	40A 400V DC	Min. 1×10 ³

Recommended circuit

Positive polarity of load should be connected to pin 1 and pin 3, refer to the following circuit schematics.

1. Each 1 Form A contact connected in series (Bottom view)

2. 1 Form A contact only (Bottom view)

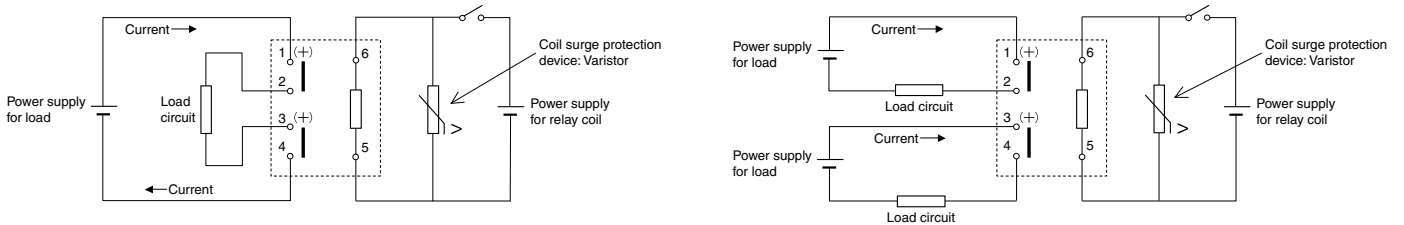

REFERENCE DATA

1. Maximum switching power

2. Ambient temperature characteristics
Tested sample: HEV2aN-P-DC12V, 6pcs

3. Coil temperature rise
Measured portion: Inside the coil
Ambient temperature: 25°C 77°F, 55°C 131°F, 85°C 185°F
Contact current: 20 A

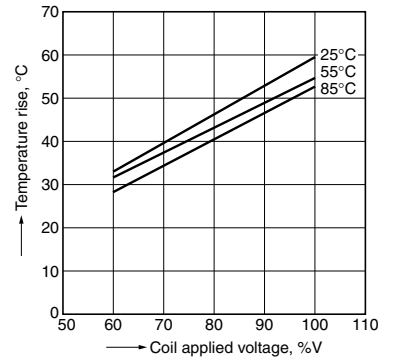
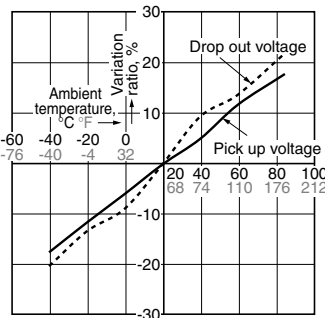
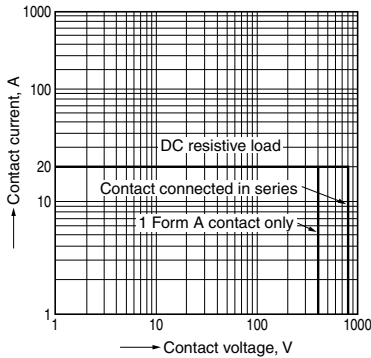

4.-(1) Cut-off life curve (forward direction)
Contact connected in series

4.-(2) Cut-off life curve (forward direction)
1 Form A contact only

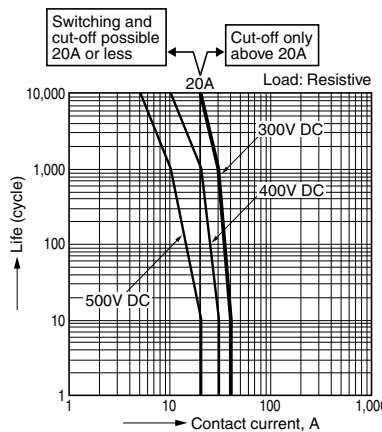
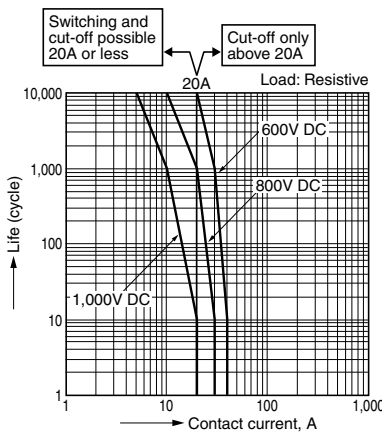

DIMENSIONS (mm inch)

The CAD data of the products with a **CAD Data** mark can be downloaded from: <http://industrial.panasonic.com/ac/e/>

CAD Data

External dimensions

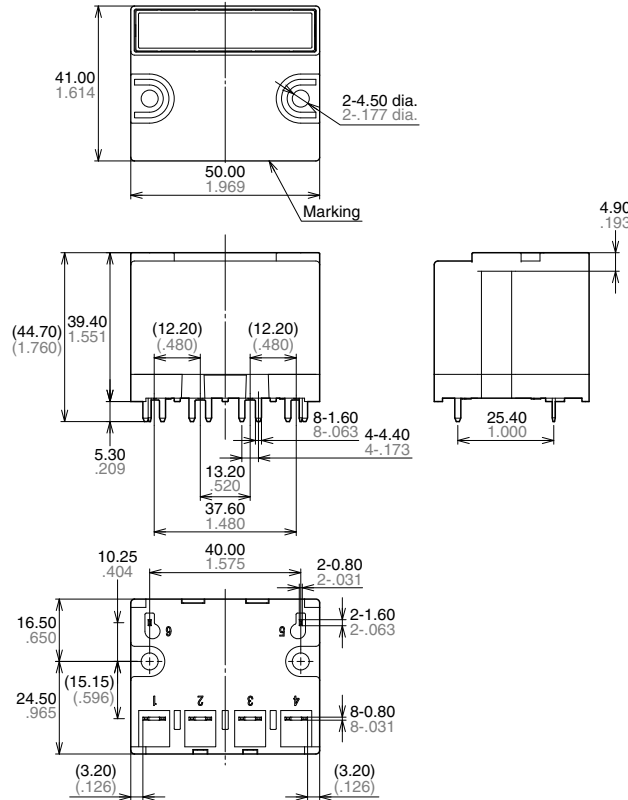

PC board pattern (Bottom view)

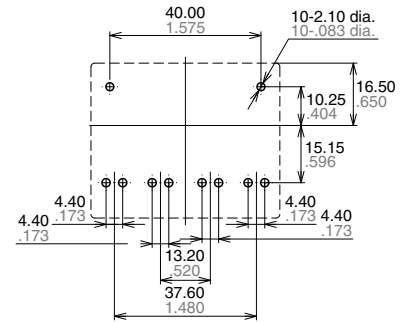

Tolerance: $\pm 0.1 \pm 0.004$

Schematic (Bottom view)

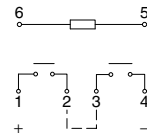

General tolerance: $\pm 0.3 \pm 0.012$

SAFETY STANDARDS

UL/C-UL (Recognized)				VDE (Certified)			
File No.	Rating	Cycles	Temperature	File No.	Rating	Cycles	Temperature
E43028	25A 600V DC Same polarity only	6x10 ³	85°C 185°F	40006681	20A 1,000V DC	6x10 ³	85°C 185°F
	20A 600V DC Same polarity only	10 ⁴	85°C 185°F		20A 800V DC	10 ³	85°C 185°F
					20A 600V DC	10 ⁴	85°C 185°F

*CSA standard: Certified by C-UL

NOTES

1. For cautions for use, please read "GENERAL APPLICATION GUIDELINES" on page B-1.

2. Usage, transport and storage conditions

1) Temperature:

-40 to +55°C -40 to +131°F (When coil holding voltage is 33 to 110%V)

-40 to +85°C -40 to +185°F (When coil holding voltage is 33% to 60%V)

2) Humidity: 5 to 85% RH

(Avoid freezing and condensation.)

The humidity range varies with the temperature. Use within the range indicated in the graph.

3) Atmospheric pressure: 86 to 106 kPa

Temperature and humidity range for usage, transport, and storage

(Coil holding voltage: 33 to 110%V)

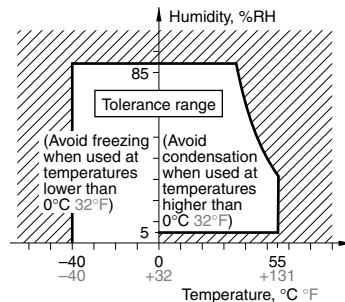

(Coil holding voltage: 33 to 60%V)

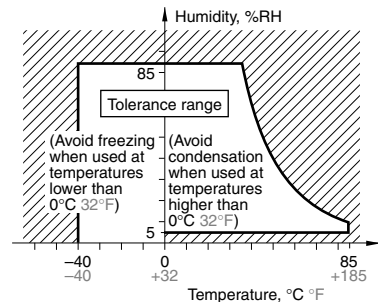

4) Condensation

Condensation forms when there is a sudden change in temperature under high temperature and high humidity conditions. Condensation will cause deterioration of the relay insulation.

5) Freezing

Condensation or other moisture may freeze on the relay when the temperatures is lower than 0°C 32°F. This causes problems such as sticking of movable parts or operational time lags.

6) Low temperature, low humidity environments

The plastic becomes brittle if the relay is exposed to a low temperature, low humidity environment for long periods of time.

3. Solder and cleaning conditions

1) Please obey the following conditions when soldering automatically.

(1) Preheating: Max. 120°C 248°F (solder surface terminal portion) and within 120 seconds

(2) Soldering iron: 260°C±5°C 500°F±41°F (solder temperature) and within 10 seconds (soldering time)

2) Please obey the following conditions when manual soldering.

Max. 260°C 500°F (solder temperature) and within 10 seconds (soldering time)

Max. 350°C 662°F (solder temperature) and within 3 seconds (soldering time)

*Effects of soldering heat on the relays vary depending on the PC board. So please confirm actual soldering condition with the PC board used for assembling.

3) Since this is not a sealed type relay, do not clean it as is. Also, be careful not to allow flux to overflow above the PC board or enter the inside of the relay.

4. Cautions for use

1) For precautions regarding use and explanations of technical terminology, please refer to our web site.

(<http://industrial.panasonic.com/ac/e/>)

2) To ensure good operation, please keep the voltage on the coil ends to ±5% (at 20°C 68°F) of the rated coil operation voltage. Also, please be aware that the pick-up voltage and drop-out voltage may change depending on the temperature and conditions of use.

3) Keep the ripple rate of the nominal coil voltage below 5%.

And do not have a parallel connection with diode for the purpose of coil surge absorber. Instead of diode, a Varistor is recommend for the absorber.

Recommended Varistor;

Maximum energy: more than 1J

Varistor voltage: 150 to 400% of nominal voltage

4) The cycle lifetime is defined under the standard test condition specified in the JIS C5442 standard (temperature 15 to 35°C 59 to 95°F, humidity 25 to 75%). Check this with the real device as it is affected by coil driving circuit, load type, activation frequency, ambient conditions and other factors.

Especially, contact terminals have polarity. So if the contact terminals were connected with opposite pole, the electric life would be shorter.

5) This value can change due to the switching frequency, environmental conditions, and desired reliability level, therefore it is recommended to check this with the actual load.

6) Heat, smoke, and even a fire may occur if the relay is used in conditions outside of the allowable ranges for the coil ratings, contact ratings, operating cycle lifetime, and other specifications. Therefore, do not use the relay if these ratings are exceeded.

7) If the relay has been dropped, the appearance and characteristics should always be checked before use.

8) Incorrect wiring may cause unexpected events or the generation of heat or flames.

9) The relay should not be installed near strong magnetic field (transformers, magnets, etc.) and should not be installed near objects that radiate heat.

10) If the several relays are mounted closely or a heat-generation object is close to the relay, take care to check the abnormal temperature-rise and the insulation distance between the terminals outside of the relay.

11) If you are using an inductive load (L load) such that $L/R > 1\text{ms}$, add surge protection in parallel with the inductive load. If this is not done, the electrical life will decrease and cut-off failure may occur.

12) In case using a capacitive load (C-load), please take a countermeasure as pre-charging to the capacitive load so that the inrush current will not surpass 40A. The relay might have a contact welding without such countermeasure.

13) This relay is a high-voltage direct-current switch. In its final breakdown mode, it may lose the ability to provide the proper cut-off. Therefore, do not exceed the indicated switching capacity and life. (Please treat the relay as a product with limited life and replace it when necessary.)

In the event that the relay loses cut-off ability, there is a possibility that burning may spread to surrounding parts, so configure the layout so that the power is turned off within one second and from the point of view of safety, consider installing a failsafe circuit in the device.

14) Please carry out the design which had a enough margin in conductor width and a space between conductors in the case of a design of a printed circuit board.

15) Contact terminals have polarity. So if the contact terminals were connected with opposite pole, the electric life would be shorter. There is no polarity if they are used for power distribution only.

Please contact

Panasonic Corporation

Electromechanical Control Business Division

■ 1006, Oaza Kadoma, Kadoma-shi, Osaka 571-8506, Japan
industrial.panasonic.com/ac/e/

Panasonic[®]

©Panasonic Corporation 2017