

THIS DOCUMENT IS THE PROPERTY OF KEYSTONE ELECTRONICS CORP. AND SHALL NOT BE REPRODUCED, DISTRIBUTED OR USED AS A BASIS FOR MANUFACTURE WITHOUT PRIOR WRITTEN PERMISSION FROM KEYSTONE ELECTRONICS CORP.

MOUNTING DETAIL

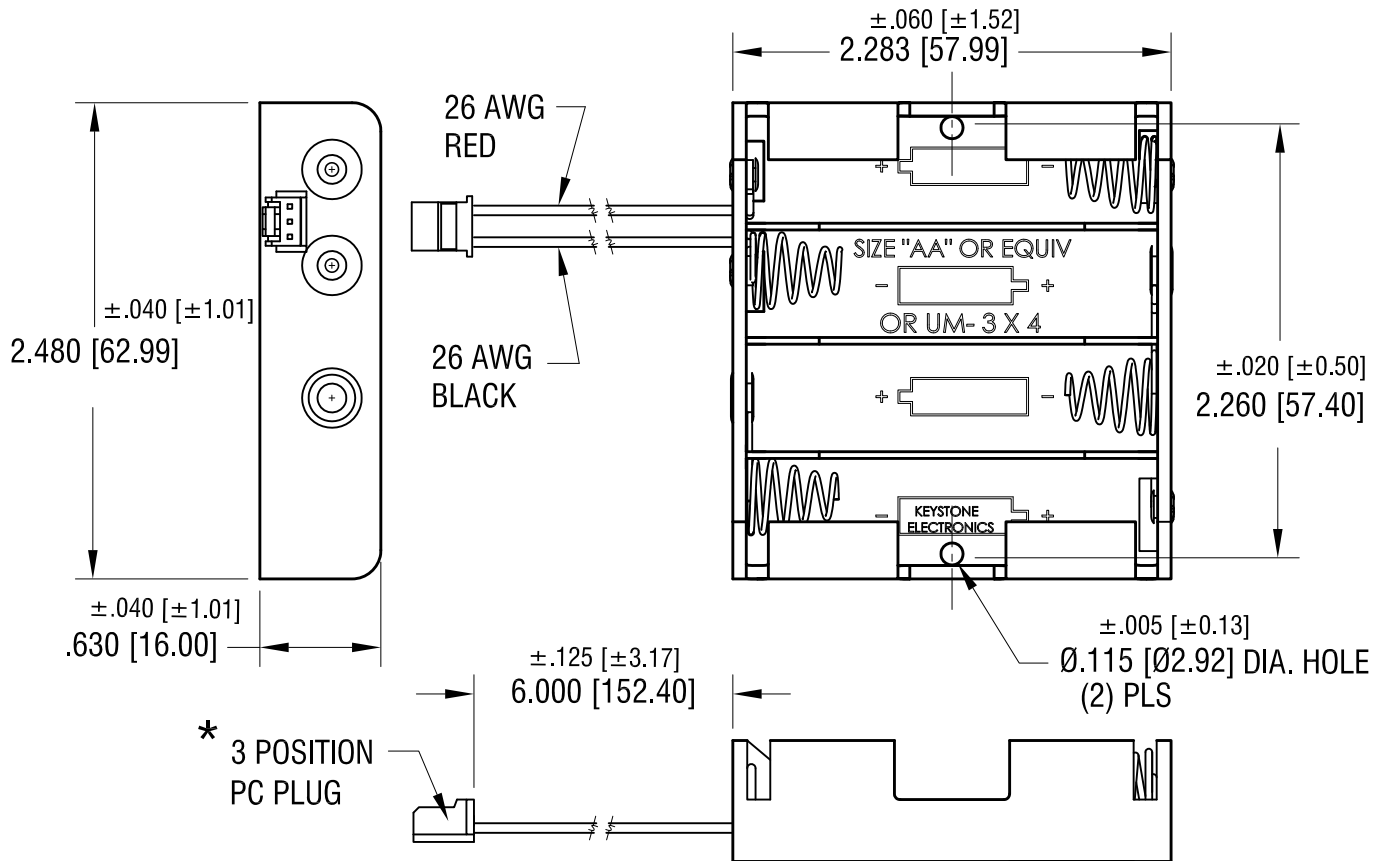
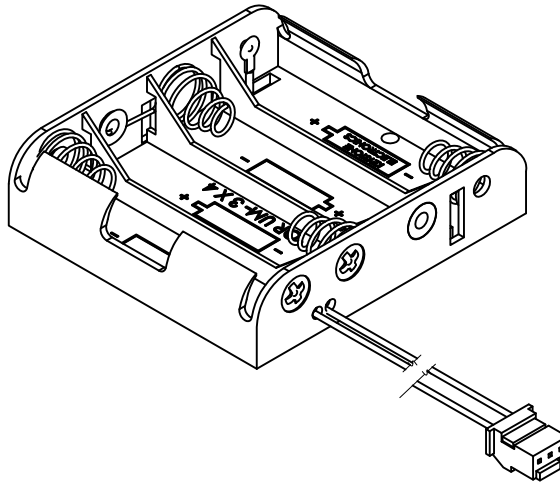
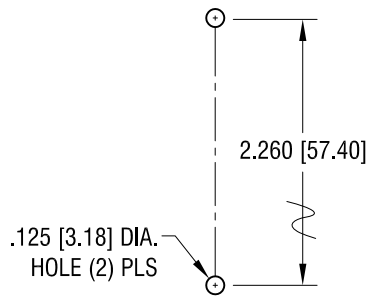

NOTE:

1. HOLDER: MAT'L: POLYPROPYLENE
2. SPRING: MAT'L: MUSIC WIRE, .027 [0.70] DIA.
FINISH: NICKEL PLATE
3. CONNECTOR: MAT'L - PA 66, UL94V-0
COLOR- NATURAL
4. POSITIVE (RED) CONNECTED TO PIN 1
NEGATIVE (BLACK) CONNECTED TO PIN 3

*USE : P/N'S 974,975, 976 OR 977 FOR P.C. CONNECTOR

KEYSTONE ELECTRONICS CORP.			
www.keyelco.com • NEW HYDE PARK, NY 11040 • Tel (516) 328-7500			
PART NAME		BATTERY HOLDER (4) 'AA'	
MATERIAL		AS NOTED	
FINISH	AS NOTED	DRN BY	NT
		APP'D	LN
		DATE	4.08.16
		SCALE	1X
TOLERANCES	INCH [MM]	CODE	DWG NO.
DECIMAL	± .015 [± 0.38]	C	2478CN
ANGULAR	± 1°		
UNLESS OTHERWISE SPECIFIED			

DATE	DESCRIPTION	REV.