

# TRIAC Dimmable Off-Line Isolated LED Driver with PFC

## DESCRIPTION

Demonstration circuit 1775A is an off-line isolated flyback LED driver featuring the LT<sup>®</sup>3799. The demo board provides a constant-current output of 0.5A over an LED string voltage of 20V and 30V. It is optimized to operate over a wide AC input voltage range (90VAC to 270VAC). LED current typically stays within  $\pm 4\%$  over the whole input voltage range. The DC1775A provides a steep decline in LED current with decreasing TRIAC dimming angle, to achieve a wide TRIAC dimming range. It is designed to comply with IEC 61000-3-2 Class C harmonics standard and EN55015B conducted EMI standard.

The LT3799 controls an isolated flyback converter in boundary mode. Its unique bleeder circuit makes the LED driver compatible with TRIAC dimmers without additional components. Its novel current sensing scheme delivers a

well-regulated output current to the secondary side without using an opto-coupler. Open- and shorted-LED protection ensures long-term reliability.

The LT3799 is available in a low profile, thermally-enhanced 16-lead MSOP package.

The LT3799 data sheet gives a complete description of the part, operation and application information. The data sheet must be read in conjunction with this quick start guide for demo circuit 1775A.

**Design files for this circuit board are available at <http://www.linear.com/demo>**

LT, LT, LTC, LTM,  $\mu$ Module, Linear Technology and the Linear logo are registered trademarks of Linear Technology Corporation. All other trademarks are the property of their respective owners.

## PERFORMANCE SUMMARY (T<sub>A</sub> = 25°C)

PARAMETER	CONDITIONS	MIN	TYP	MAX	UNITS
Input Range	Line Frequency, 47Hz to 63Hz	90	120	270	VAC
Output Current	V <sub>IN</sub> = 120VAC, V <sub>LED</sub> = 28V		0.5		A
Output Voltage		20	28	30	V
Open LED Voltage	(Note 1)		34		V

**Note 1:** For applications with low LED string voltage, FB pin divider resistor R6 and output clamp D3 can be adjusted to reduce the open voltage limit. See Protection from Open LED and Shorted LED Faults section in the LT3799 data sheet for details.

## QUICK START PROCEDURE

### IMPORTANT NOTE TO CUSTOMERS:

HIGH VOLTAGES ARE PRESENTED ON THE DEMO CIRCUIT, AND CAN LEAD TO LETHAL INJURIES TO HUMAN BODY. ONLY QUALIFIED PERSONNEL SHOULD OPERATE IT. IT IS STRONGLY RECOMMENDED TO USE SAFETY GLASSES AND AN ISOLATION TRANSFORMER.

NOTE. IMPROPER COMPONENTS REPLACEMENT ON THE DEMO CIRCUIT CAN CAUSE PERFORMANCE DEGRADATIONS, CIRCUIT MALFUNCTION, PROPERTY DAMAGE, AND EVEN LIFE-THREATENING INJURIES. CONTACT LINEAR TECHNOLOGY APPLICATIONS ENGINEERS FOR PROPER COMPONENT REPLACEMENT.

Demonstration circuit 1775A is easy to set up to evaluate the performance of the LT3799. Refer to Figure 1 for proper measurement equipment setup and follow the procedure below:

1. Connect a 0.5A LED string with forward voltage less than 30V, but greater than 20V, between LED<sup>+</sup> and LED<sup>-</sup> terminals.
2. With power off, connect the input power supply to line (L) input and neutral (N) input.
3. Turn on the power at the input.

Note: Make sure that the input voltage does not exceed the maximum input voltage (270VAC).

4. Check for the proper output current.

Once the proper output current is established, adjust the input voltage and/or the load and observe the output current regulation, efficiency, power factor and other parameters.

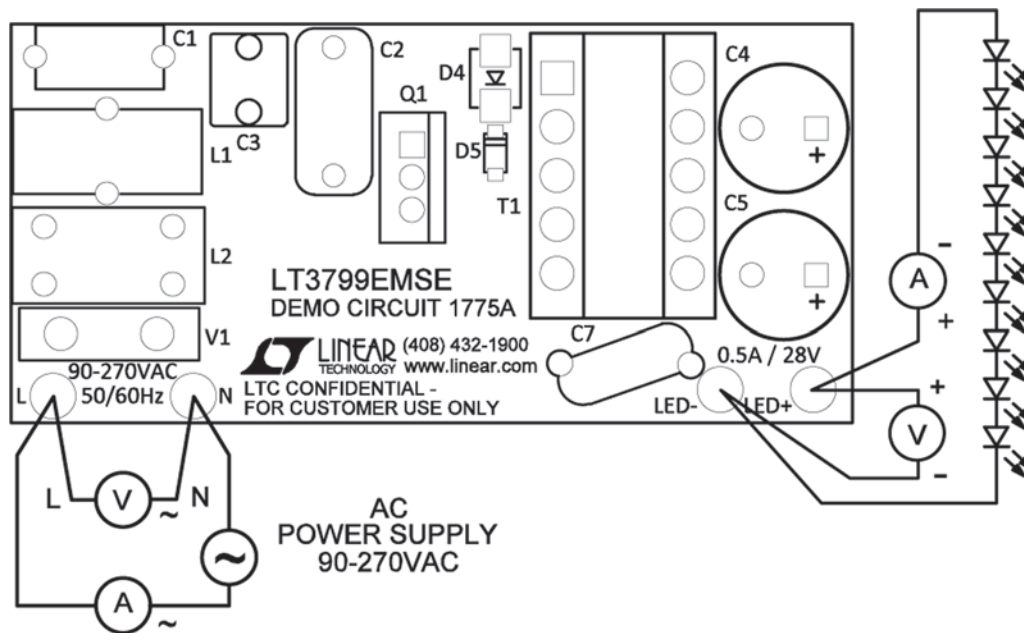

Figure 1. Proper Measurement Equipment Setup

## QUICK START PROCEDURE

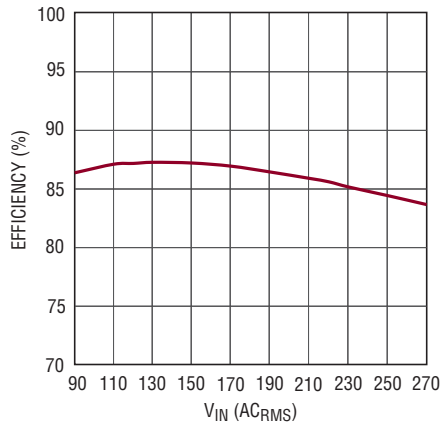

Figure 2. Efficiency vs Input Voltage

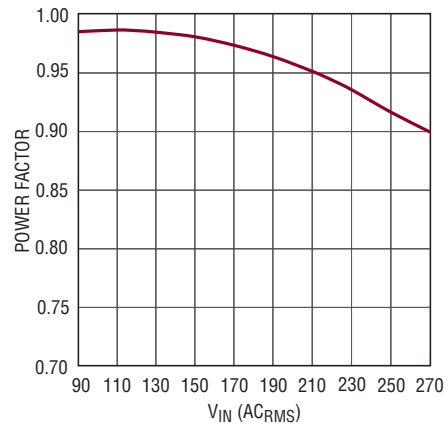

Figure 3. Power Factor vs Input Voltage

## Input Line Voltage and Current

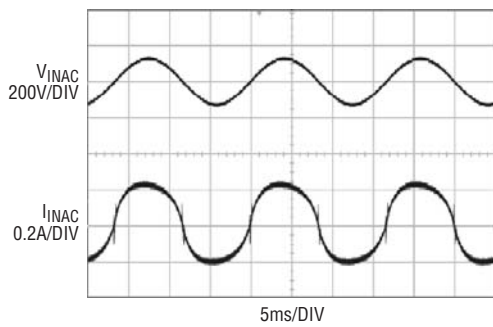

Figure 4.  $V_{IN} = 90VAC$

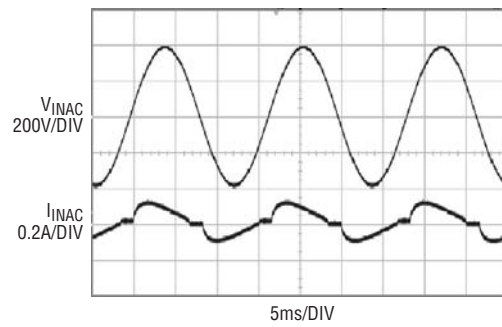

Figure 5.  $V_{IN} = 270VAC$

## Switch Node Voltage

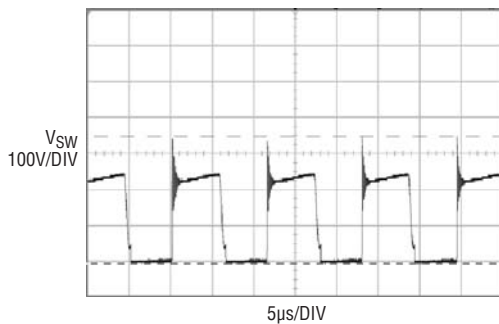

Figure 6.  $V_{IN} = 90VAC$

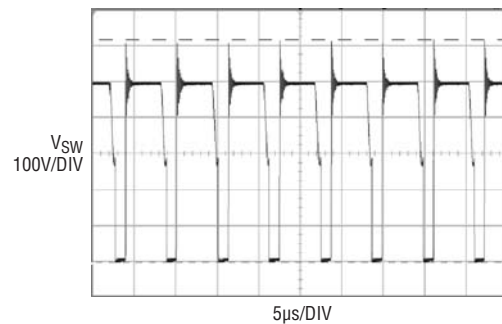

Figure 7.  $V_{IN} = 270VAC$

## QUICK START PROCEDURE

### Output Voltage and Switch Node Voltage During Output Open

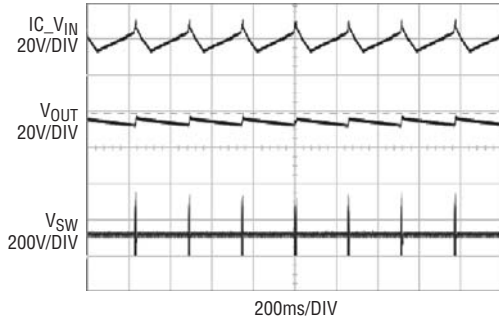

Figure 8.  $V_{IN} = 90VAC$

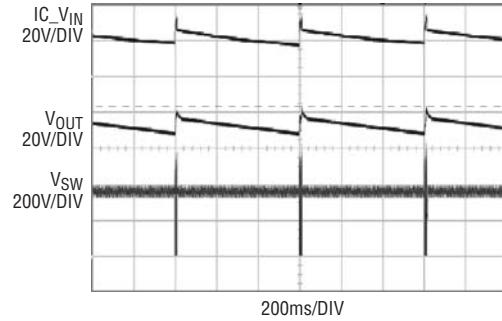

Figure 9.  $V_{IN} = 270VAC$

### Output Current and Switch Node Voltage During Output Short

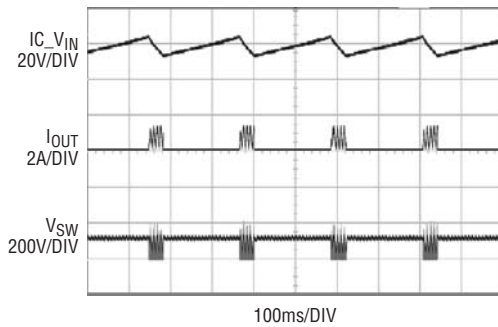

Figure 10.  $V_{IN} = 90VAC$

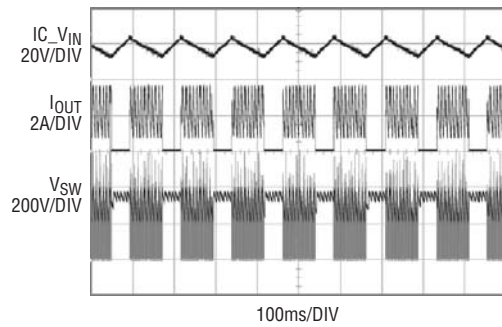

Figure 11.  $V_{IN} = 270VAC$

### LED Current vs TRIAC Dimming Angle

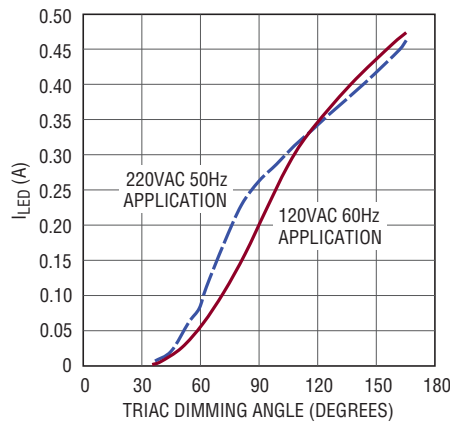

Figure 12. LED Current vs TRIAC Dimming Angle: Solid Line, 120VAC 60Hz; Dot Line, 220VAC 50Hz.  
 Note: For Different Types of TRIAC Dimmers, the Maximum and/or Minimum Dimming Angle May Vary, Which Gives Different Maximum and/or Minimum LED Current

## QUICK START PROCEDURE

### Input Voltage and Switch Node Voltage with 120VAC, 60Hz TRIAC Dimmer

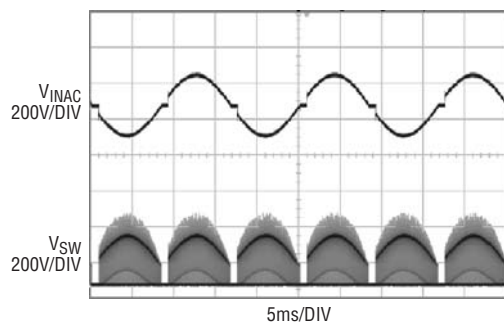

Figure 13. 165 Degree TRIAC Dimming Angle

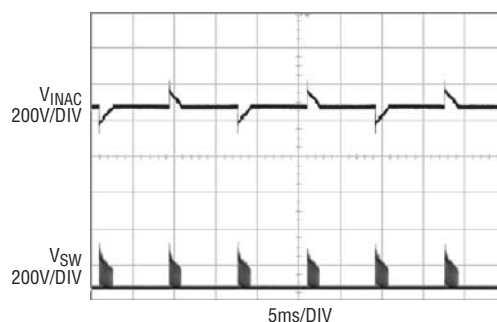

Figure 14. 35 Degree TRIAC Dimming Angle

### Input Voltage and Switch Node Voltage with 220VAC, 50Hz TRIAC Dimmer

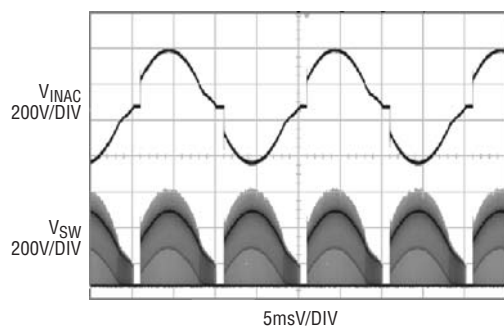

Figure 15. 165 Degree TRIAC Dimming Angle

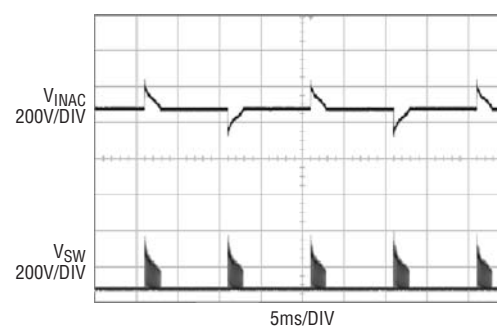

Figure 16. 35 Degree TRIAC Dimming Angle

# DEMO MANUAL DC1775A

## PARTS LIST

ITEM	QTY	REFERENCE	PART DESCRIPTION	MANUFACTURER/PART NUMBER
<b>Required Circuit Components</b>				
1	1	B1	RECTIFIER, BRIDGE GP 600V 0.8A MINIDIP	DIODES INC., HD06-T
2	1	C1	CAP, MKP 0.047 $\mu$ F 310VAC 20%	VISHAY, BFC233921473
3	1	C2	CAP, POLY 220nF 450V 10%	RUBYCON, 450MMK224K
4	1	C3	CAP, POLYESTER FILM 47nF 400V 10%	VISHAY, BFC237051473
5	2	C4, C5	CAP, ALUM 330 $\mu$ F 50V 20% RADIAL	PANASONIC, EEU-FR1H331L
6	1	C6	CAP, CERAMIC 10 $\mu$ F 50V 10% 1210	MURATA, GRM32ER71H106KA12L
7	1	C7	CAP, Y5U 2200pF 400VAC 20%	VISHAY, 440LD22-R
8	1	C8	CAP, NPO 4.7pF 50V $\pm$ 0.25PF 0603	AVX, 06035A4R7CAT2A
9	1	C9	CAP, X5R 2.2 $\mu$ F 16V 20% 0603	TDK, C1608X5R1C225M
10	2	C10, C13	CAP, X7R 0.1 $\mu$ F 16V 10% 0603	AVX, 0603YC104KAT2A
11	1	C11	CAP, X5R 4.7 $\mu$ F 25V 10% 0805	AVX, 08053D475KAT2A
12	1	C12	CAP, X7R 0.022 $\mu$ F 25V 10% 0603	AVX 06033C223KAT1A
13	1	D1	DIODE, SCHOTTKY 1A/200V POWERDI-123	DIODES INC., DFLS1200-7
14	2	D2, D6	DIODE, SWITCH 400MA 150V SOD123	DIODES INC., BAV20W-7-F
15	1	D3	DIODE, ZENER 1.5W	CENTRAL SEMI, CMZ5938B TR
16	1	D4	TVS UNIDIRECT 600W 170V SMB	DIODES INC., SMBJ170A-13-F
17	1	D5	DIODE, ULTRAFAST RECOVERY RECTIFIER SOD123	CENTRAL SEMI., CMMR1U-06
18	1	F1	FUSE, 1A	COOPER BUSSMANN, 1025FA1-R
19	1	L1	IND, 750 $\mu$ H	WURTH, 750311431
20	1	L2	IND, 39mH COMMON MODE CHOKE	WURTH, 744821039
21	1	Q1	MOSFET N-CHAN., 650V/7A TO-220F	FAIRCHILD SEMI., FQPF7N65C
22	1	Q2	TRANS., PNP 40V 300MW SMD SOT23-3	DIODES INC., MMBT3906-7-F
23	2	R1, R2	RES., CHIP 249 $\Omega$ 0.5W 1% 1210	VISHAY, CRCW1210249RFKEA
24	2	R3, R21	RES., CHIP 100k 0.06W 5% 0603	YAGEO, RC0603JR-07100KL
25	1	R4	RES., CHIP 8.06k 0.25W 1% 1206	YAGEO, RC1206FR-078K06L
26	2	R5, R17	RES., CHIP 20 $\Omega$ 0.06W 5% 0603	YAGEO, RC0603JR-0720RL
27	1	R6	RES., CHIP 4.53k 0.06W 1% 0603	YAGEO, RC0603FR-074K53L
28	4	R7, R8, R12, R13	RES., CHIP 499k 0.25W 1% 1206	YAGEO, RC1206FR-07499KL
29	1	R9	RES., CHIP 130k 0.25W 1% 1206	VISHAY, CRCW1206130KFKEA
30	1	R10	RES., CHIP 2k 0.06W 5% 0603	YAGEO, RC0603JR-072KL
31	1	R11	RES., CHIP 590k 0.06W 1% 0603	VISHAY, CRCW0603590KFKEA
32	1	R14	RES., CHIP 100k 0.25W 5% 1206	VISHAY, CRCW1206100KJNEA
33	1	R15	RES., CHIP 32.4k 0.06W 1% 0603	VISHAY, CRCW060332K4FKEA
34	1	R16	RES., CHIP 3.48k 0.06W 1% 0603	YAGEO, RC0603FR-073K48L
35	1	R18	RES., CHIP 40.2k 0.06W 1% 0603	VISHAY, CRCW060340K2FKEA
36	1	R19	RES., CHIP 15k 0.06W 5% 0603	YAGEO, RC0603JR-0715KL
37	1	R20	RES., CHIP 0.1 $\Omega$ 0.25W 1% 1206	YAGEO, PT1206FR-070R1L
38	1	R22	RES., CHIP 10.7k 0.06W 1% 0603	VISHAY, CRCW060310K7FKEB
39	1	T1	XFMR., 700 $\mu$ H, 10kHz $\pm$ 10%	WURTH ELEKTRONIK, 7508111417
40	1	U1	IC, TRIAC DIMMABLE OFFLINE LED DRIVER	LINEAR TECH., LT3799EMSE#PBF
41	1	V1	VARIATOR 320V <sub>RMS</sub> 13.5MM RADIAL	VISHAY, VDRS10P320BSE
42	1		FAB, 1775A REV 4. PCB	DEMO CIRCUIT 1775A
<b>Hardware-For Demo Board Only:</b>				
1	4	E1, E2, E4, E5	TURRET, TESTPOINT	MILL MAX, 2501-2-00-80-00-00-07-0
2			STENCIL (TOP AND BOTTOM)	STENCIL DC1775A

dc1775afa

**SCHEMATIC DIAGRAM**

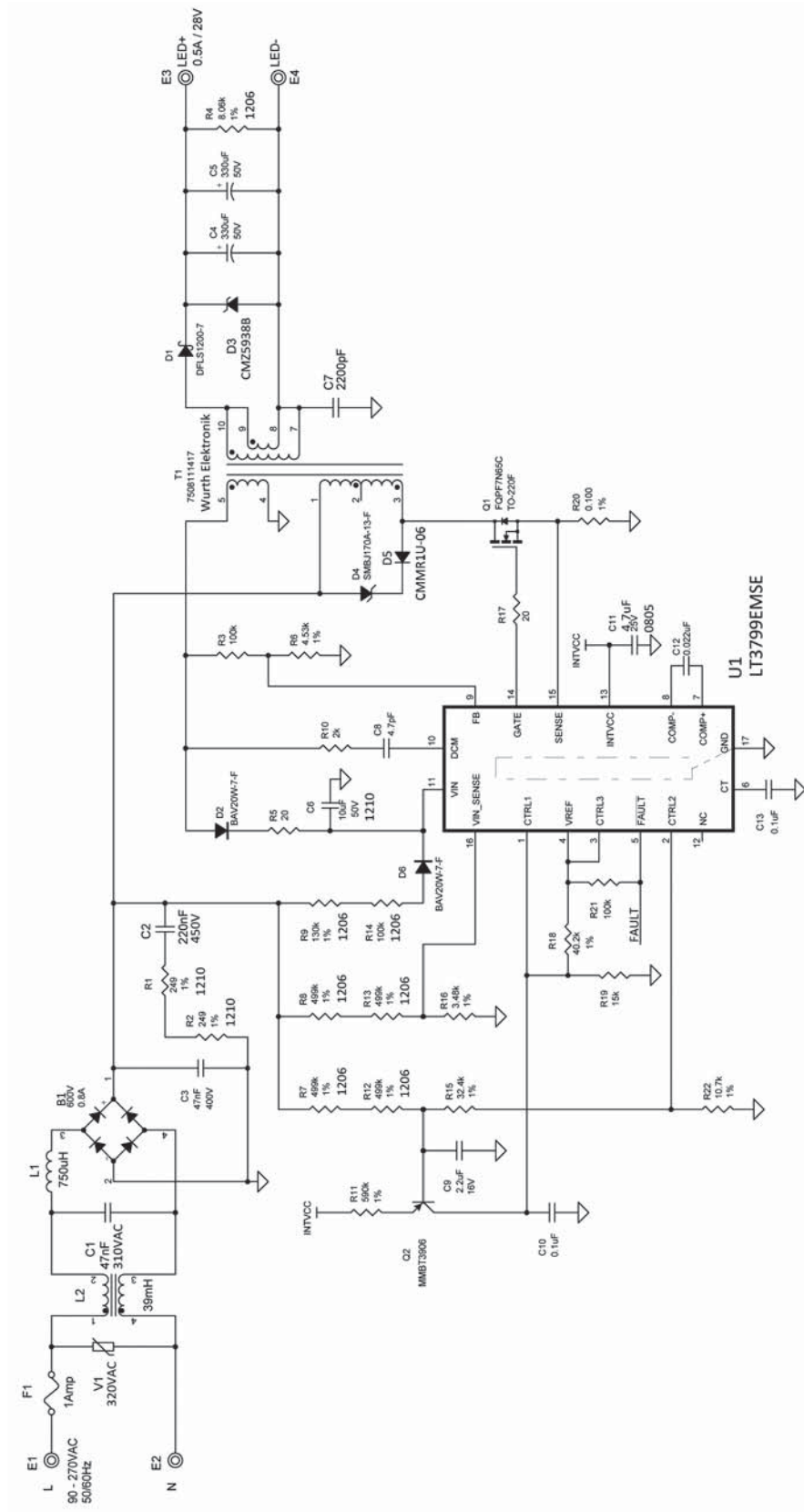

# DEMO MANUAL DC1775A

---

## DEMONSTRATION BOARD IMPORTANT NOTICE

Linear Technology Corporation (LTC) provides the enclosed product(s) under the following **AS IS** conditions:

This demonstration board (DEMO BOARD) kit being sold or provided by Linear Technology is intended for use for **ENGINEERING DEVELOPMENT OR EVALUATION PURPOSES ONLY** and is not provided by LTC for commercial use. As such, the DEMO BOARD herein may not be complete in terms of required design-, marketing-, and/or manufacturing-related protective considerations, including but not limited to product safety measures typically found in finished commercial goods. As a prototype, this product does not fall within the scope of the European Union directive on electromagnetic compatibility and therefore may or may not meet the technical requirements of the directive, or other regulations.

If this evaluation kit does not meet the specifications recited in the DEMO BOARD manual the kit may be returned within 30 days from the date of delivery for a full refund. **THE FOREGOING WARRANTY IS THE EXCLUSIVE WARRANTY MADE BY THE SELLER TO BUYER AND IS IN LIEU OF ALL OTHER WARRANTIES, EXPRESSED, IMPLIED, OR STATUTORY, INCLUDING ANY WARRANTY OF MERCHANTABILITY OR FITNESS FOR ANY PARTICULAR PURPOSE. EXCEPT TO THE EXTENT OF THIS INDEMNITY, NEITHER PARTY SHALL BE LIABLE TO THE OTHER FOR ANY INDIRECT, SPECIAL, INCIDENTAL, OR CONSEQUENTIAL DAMAGES.**

The user assumes all responsibility and liability for proper and safe handling of the goods. Further, the user releases LTC from all claims arising from the handling or use of the goods. Due to the open construction of the product, it is the user's responsibility to take any and all appropriate precautions with regard to electrostatic discharge. Also be aware that the products herein may not be regulatory compliant or agency certified (FCC, UL, CE, etc.).

No License is granted under any patent right or other intellectual property whatsoever. **LTC assumes no liability for applications assistance, customer product design, software performance, or infringement of patents or any other intellectual property rights of any kind.**

LTC currently services a variety of customers for products around the world, and therefore this transaction **is not exclusive**.

**Please read the DEMO BOARD manual prior to handling the product.** Persons handling this product must have electronics training and observe good laboratory practice standards. **Common sense is encouraged.**

This notice contains important safety information about temperatures and voltages. For further safety concerns, please contact a LTC application engineer.

Mailing Address:

Linear Technology  
1630 McCarthy Blvd.  
Milpitas, CA 95035

Copyright © 2004, Linear Technology Corporation