

MAX17552 5V Output Evaluation Kit (TDFN)

Evaluates: MAX17552 (TDFN) in 5V Output Voltage Applications

General Description

The MAX17552 5V evaluation kit (EV kit) (TDFN) is a fully assembled and tested circuit board that demonstrates the performance of the MAX17552 60V, 100mA ultra-small, high-efficiency, synchronous step-down DC-DC converter in a 10-pin TDFN package. The EV kit operates over a wide input-voltage range of 6V to 60V and provides up to 100mA load current at 5V output. It draws only 26 μ A supply current under no-load conditions (EN/UVLO connected to V_{IN}). The EV kit is programmed to switch at a frequency of 220kHz and delivers a peak efficiency of 93% with the supplied components. The device is simple to use and easily configurable with minimal external components. It features cycle-by-cycle peak current limit protection, undervoltage lockout, and thermal shutdown.

The EV kit comes installed with the MAX17552ATB+ in an 10-pin (3mm x 3mm) lead(Pb)-free/RoHS-compliant TDFN package.

Features and Benefits

- 6V to 60V Input Voltage Range
- 5V Output, 100mA Continuous Current
- 93% Peak Efficiency
- 26 μ A No Load Supply Current
- EN/UVLO for On/Off Control and Programmable Input Undervoltage Lockout
- Programmable Switching Frequency
- Internal or Programmable Soft-Start
- PFM or Forced-PWM Mode of Operation
- Open-Drain \overline{RESET} Output
- Peak Current Limit Protection
- Thermal Shutdown
- Proven PCB Layout
- Fully Assembled and Tested

Ordering Information appears at end of data sheet.

TDFN is a registered trademark of Maxim Integrated Products, Inc.

Quick Start

Recommended Equipment

- MAX17552 5V EV kit (TDFN)
- 60V adjustable, 0.5A DC power supply
- Electronic load up to 100mA
- Voltmeter

Procedure

The EV kit is fully assembled and tested. Follow the steps below to verify board operation. **Caution: Do not turn on the power supply until all connections are completed.**

- 1) Verify that shunts are installed on jumpers JU1, JU2 (EN/UVLO).
- 2) Verify that jumper JU3 (MODE-PFM operation) is open.
- 3) Set the electronic load to constant-current mode, 100mA, and disable the electronic load.
- 4) Connect the electronic load's positive terminal to the VOUT PCB pad. Connect the negative terminal to the GND PCB pad.
- 5) Connect the voltmeter across the VOUT and GND PCB pads.
- 6) Set the power-supply output to 24V. Disable the power supply.
- 7) Connect the power-supply output to the VIN PCB pad. Connect the supply ground to the GND PCB pad.
- 8) Turn on the power supply.
- 9) Enable the electronic load and verify that output voltage is 5V with respect to GND.
- 10) Vary the input voltage from 6V to 60V.
- 11) Vary the load current from 1mA to 100mA and verify that output voltage is 5V with respect to GND.

Note: While performing an output short-circuit test, it is possible for the ceramic output capacitor to oscillate with the wiring inductance between the capacitor and short-circuited load, and thereby cause the absolute maximum rating of the VOUT pin (-0.3V) to be exceeded. The resistor (R7) and the capacitor (C5) are included on this evaluation kit to protect against unintentional violation of the above mentioned rating. In the actual system design, parasitic board or wiring inductance should be minimized and the output-voltage waveform under short-circuit operation should be verified to ensure that the absolute maximum rating of the VOUT pin is not exceeded.



Detailed Description

The MAX17552 5V EV kit (TDFN) is a fully assembled and tested circuit board that demonstrates the performance of the MAX17552 60V, 100mA ultra-small, high-efficiency, synchronous step-down DC-DC converter in a 10-pin TDFN package. The EV kit operates over a wide input voltage range of 6V to 60V and provides up to 100mA load current at 5V output. It draws only 26µA supply current under no-load conditions (EN/UVLO connected to VIN). The EV kit is programmed to switch at a frequency of 220kHz and delivers a peak efficiency of 93% with the supplied components. The device is simple to use and easily configurable with minimal external components. It features cycle-by-cycle peak current limit protection, undervoltage lockout, and thermal shutdown.

The EV kit includes an EN/UVLO PCB pad and jumpers JU1 and JU2 to enable control of the converter output. The MODE PCB pad and jumper JU3 are provided for selecting the mode of operation of the converter. A RESET PCB pad is available for monitoring the RESET output. The RT/SYNC PCB pad can be used to synchronize the EV kit switching frequency to an external clock frequency.

Enable Control (JU1, JU2)

The EN/UVLO pin on the EV kit serves as an on/off control while also allowing the user to program the input undervoltage lockout (UVLO) threshold. Jumpers JU1 and JU2 configure the EV kit's output for turn-on/turn-off control. See [Table 1](#) for proper JU1, JU2 jumper configurations.

Additionally, resistors R1 and R2 are included to set the UVLO to a desired turn-on voltage. Refer to the *Setting the Input Undervoltage-Lockout Level* section in the MAX17552 IC data sheet for additional information on setting the UVLO threshold voltage.

Table 1. Enable Control (EN/UVLO) (JU1, JU2)

SHUNT POSITION		EN/UVLO PIN	VOUT OUTPUT
JU1	JU2		
1-2	Open	Connected to VIN	Enabled
Open	1-2	Connected to GND	Disabled
1-2*	1-2	Connected to midpoint of R1, R2 resistor-divider	Enabled at VIN ≥ 6V

*Default position.

Table 2. MODE Control (JU3)

SHUNT POSITION	MODE PIN	MODE OF OPERATION
1-2	Connected to GND	Forced PWM
Open*	Unconnected	PFM

*Default position.

RESET Output

The EV kit provides a PCB pad to monitor the status of the RESET output. RESET goes high and when the output voltage rises above 95% (typ) of its nominal regulated output voltage. RESET goes low when output voltage falls below 92% (typ) of its nominal regulated voltage.

PFM or Forced-PWM Mode (MODE)

The EV kit includes a jumper (JU3) to select the mode of operation of the converter. Install a shunt across JU3 before powering up the EV kit to enable the forced-PWM operation. Keep JU3 open to enable the light-load PFM operation. See [Table 2](#) for proper JU3 settings.

Soft-Start

The EV kit offers a fixed 5ms soft-start time. Connect the capacitor C4 to adjust the soft-start time (t_{SS}). Use the following equation to determine the soft-start capacitance value (C_{SS}).

$$C_{SS} = 6.25 \times t_{SS}$$

where t_{SS} is in milliseconds and C_{SS} is in nanofarads.

External Synchronization (RT/SYNC)

The EV kit provides a PCB pad to synchronize the EV kit switching frequency to an external clock frequency. Apply the external clock to the RT/SYNC PCB pad through an AC-coupling capacitor. Refer to the *External Synchronization* section in the MAX17552 IC data sheet for additional information on configuring the external clock and selecting the AC-coupling capacitor.

MAX17552 5V Output Evaluation Kit (TDFN)

Evaluates: MAX17552 (TDFN) in 5V Output Voltage Applications

EV Kit Performance Report

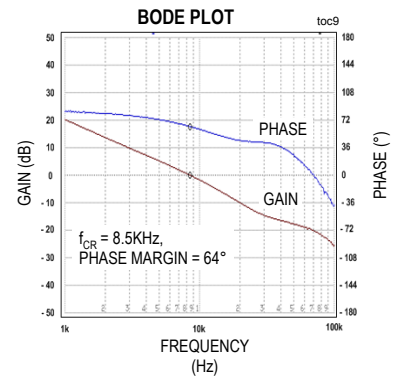
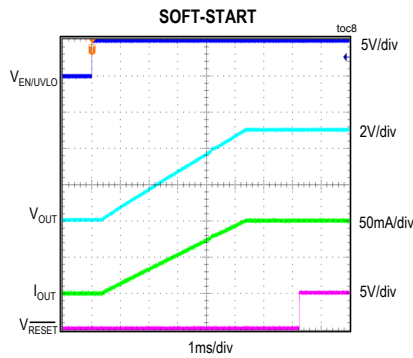
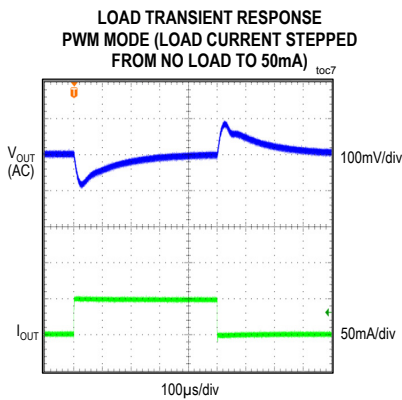
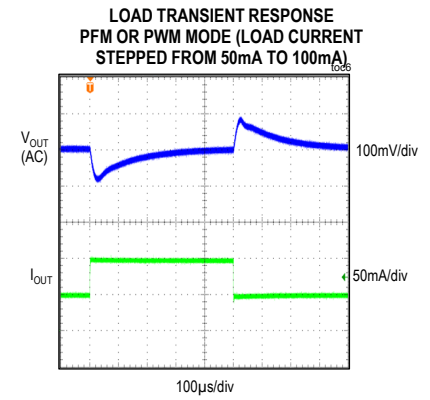
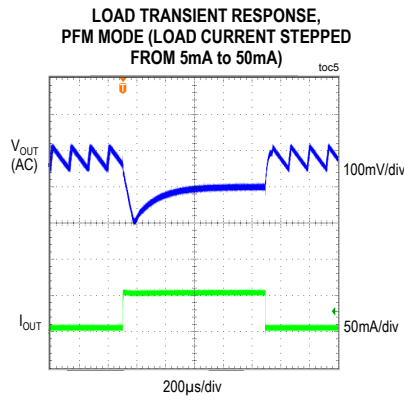
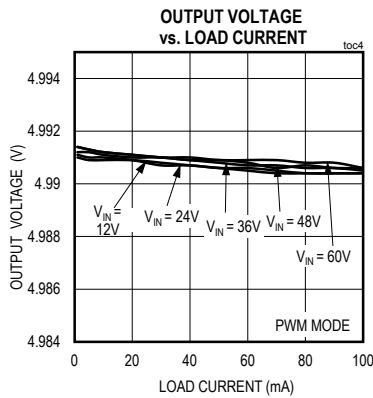
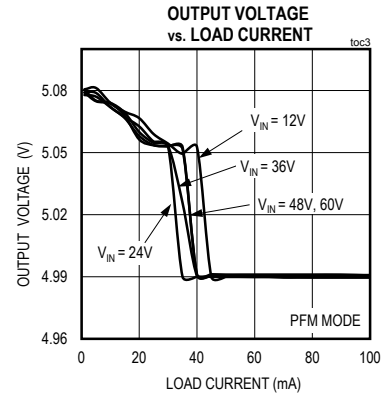
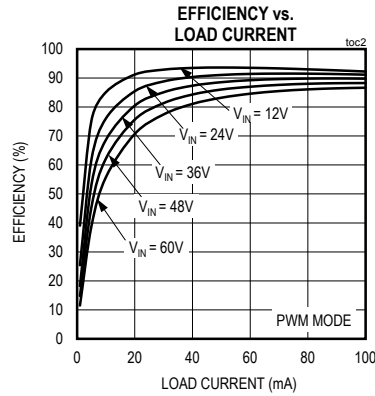
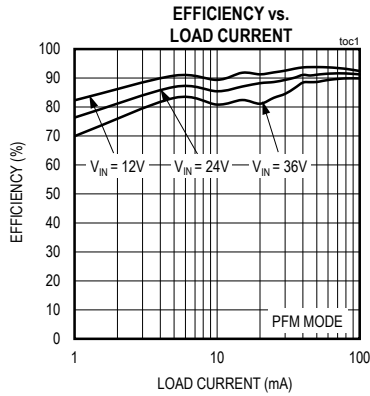

MAX17552 5V Output Evaluation Kit (TDFN)

Evaluates: MAX17552 (TDFN) in 5V Output Voltage Applications

Component List

DESIGNATION	QTY	DESCRIPTION
C1	1	22 μ F, 100V electrolytic capacitor (8.3mm x 8.3mm) Panasonic EEVFK2A220P
C2	1	1 μ F \pm 10%, 100V X7R ceramic capacitor (1206) Murata GRM31CR72A105K
C3	1	10 μ F \pm 10%, 6.3V X7R ceramic capacitor (1206) Murata GRM31CR70J106K
C4	0	Not installed, ceramic capacitor
C5	1	0.22 μ F \pm 10%, 16V X7R ceramic capacitor (0402) Murata GRM155R71C224K
JU1–JU3	3	2-pin headers
L1	1	220 μ H, 235mA inductor Coilcraft, Inc. LPS5030-224ML

DESIGNATION	QTY	DESCRIPTION
R1	1	3.01M Ω \pm 1% resistor (0402)
R2	1	787k Ω \pm 1% resistor (0402)
R3	1	191k Ω \pm 1% resistor (0402)
R4	1	261k Ω \pm 1% resistor (0402)
R5	1	49.9k Ω \pm 1% resistor (0402)
R6	1	100k Ω \pm 1% resistor (0402)
R7	1	22.1 Ω \pm 1% resistor (0402)
U1	1	60V, 100mA, ultra-small, high-efficiency, synchronous step-down DC-DC converter with 22 μ A no-load supply current (10 TDFN-EP*) Maxim MAX17552ATB+
—	3	Shunts
—	1	PCB: MAX17552ATB-5V EVALUATION KIT

Component Suppliers

SUPPLIER	PHONE	WEBSITE
Coilcraft, Inc.	847-639-6400	www.coilcraft.com
Murata Americas	770-436-1300	www.murataamericas.com
Panasonic Corp.	800-344-2112	www.panasonic.com

Note: Indicate that you are using the MAX17552ATB when contacting these component suppliers.

MAX17552 5V Output
Evaluation Kit (TDFN)

Evaluates: MAX17552 (TDFN) in
5V Output Voltage Applications

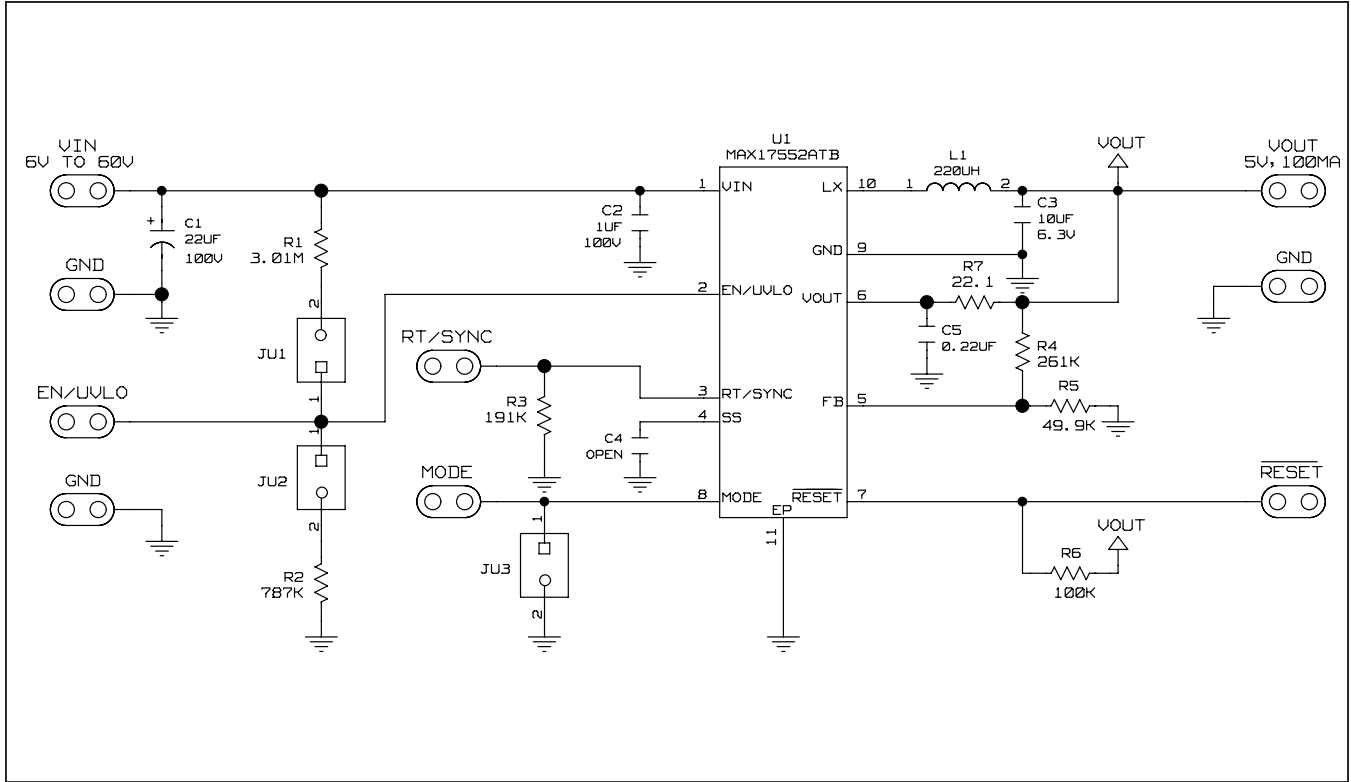

Figure 1. MAX17552 5V EV Kit (TDFN) Schematic

MAX17552 5V Output Evaluation Kit (TDFN)

Evaluates: MAX17552 (TDFN) in 5V Output Voltage Applications

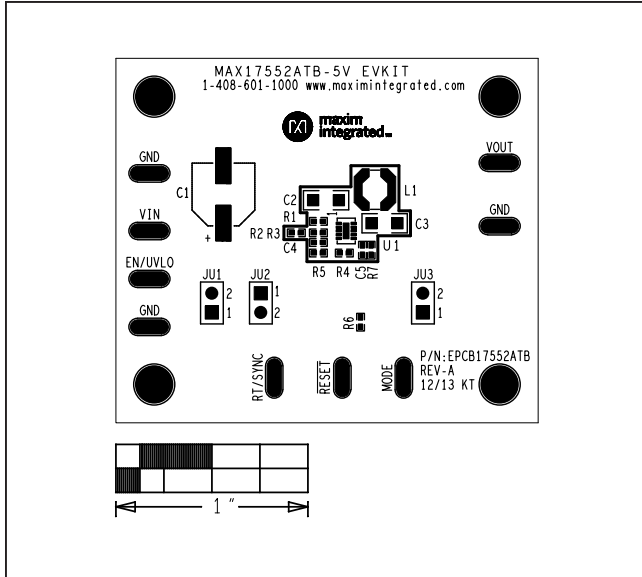

Figure 2. MAX17552 5V EV Kit (TDFN) Component Placement Guide—Component Side

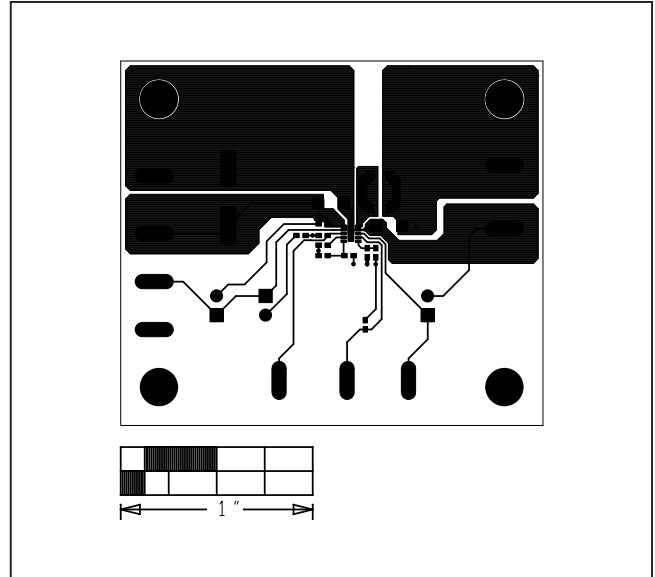

Figure 3. MAX17552 5V EV Kit (TDFN) PCB Layout—Component Side

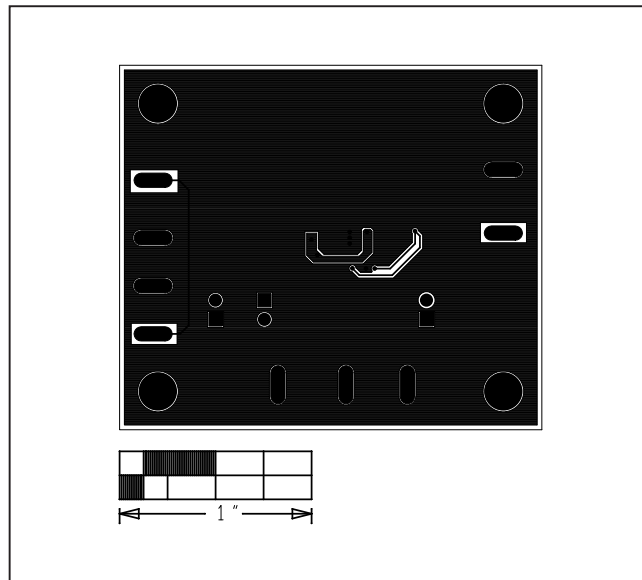

Figure 4. MAX17552 5V EV Kit (TDFN) PCB Layout—Solder Side

MAX17552 5V Output
Evaluation Kit (TDFN)

Evaluates: MAX17552 (TDFN) in
5V Output Voltage Applications

Ordering Information

PART	TYPE
MAX17552ATBEVKIT#	EV Kit

#Denotes RoHS compliant.

Revision History

REVISION NUMBER	REVISION DATE	DESCRIPTION	PAGES CHANGED
0	1/14	Initial release	—
1	4/14	Updated <i>Ordering Information</i> table	7

For pricing, delivery, and ordering information, please contact Maxim Direct at 1-888-629-4642, or visit Maxim Integrated's website at www.maximintegrated.com.

Maxim Integrated cannot assume responsibility for use of any circuitry other than circuitry entirely embodied in a Maxim Integrated product. No circuit patent licenses are implied. Maxim Integrated reserves the right to change the circuitry and specifications without notice at any time.