

EMIGUARD® (Three-Terminal Varistor-Capacitor)
VFS9V Series Reference Specification

1.Scope

This reference specification applies to Disc-Type EMIFIL® (Three-terminal Varistor-Capacitor).

2.Part Numbering

- (Ex.)

VF	S	9	V	D3	1B	223	Q93	J
①	②	③	④	⑤	⑥	⑦	⑧	⑨
- ① Product ID (EMIGUARD® Lead Type)
 - ② Structure
 - ③ Style
 - ④ Features
 - ⑤ Temperature Characteristics
 - ⑥ Rated Voltage
 - ⑦ Capacitance
 - ⑧ Lead Type Q55 : Bulk / Q9 : Taping See item 9.
 - ⑨ Packaging Code B : Bulk / J : ϕ 320mm reel

(Bulk)

Customer Part Number	Part Number	Unit Mass (Typical value)
	VFS9VD31B223Q55B	1.2g

(Taping)

Customer Part Number	Part Number	Unit Mass (Typical value)
	VFS9VD31B223Q91J	1.1g
	VFS9VD31B223Q92J	
	VFS9VD31B223Q93J	

3.Rating

Temperature Characteristics	D3 (± $\frac{20}{30}$ %) (-25 to +85°C)	
Capacitance value	22000 pF	
Capacitance Tolerance	± $\frac{50}{20}$ %	
Rated Voltage	12 V(DC)	
Varistor Voltage(V _{1mA})	22V(DC) ± 20%	
Voltage Ratio	1.25 max.(V _{10mA} / V _{1mA})	
Insulation Resistance	1MΩ min.	
Rated Current	Bulk : 7A (DC)	Taping : 6A (DC)
Operating Temperature	-40 to +100°C	
Storage Temperature	-40 to +100°C	
Equivalent Circuit		
	1g	

4.Style and Dimensions

See item 9.

5.Marking

- Temperature Characteristics : D (Temperature Characteristics Number : D3)
- Capacitance : Marked three digits system
- Capacitance Tolerance : Marked letter code. S (± $\frac{50}{20}$ %)
- Rated Voltage : Marked voltage value. (12V → 12)
- Varistor Voltage : Marked voltage value. (22V → 22)
- Trade Mark : Marked as

6. Testing Condition

<Unless otherwise specified>

Temperature : Ordinary Temperature 15 to 35 °C
 Humidity : Ordinary Humidity 25 to 85%RH

<In case of doubt>

Temperature : 20±2°C
 Humidity : 60 to 70%
 Atmospheric Pressure : 86 to 106 kPa

7. Electrical Performance

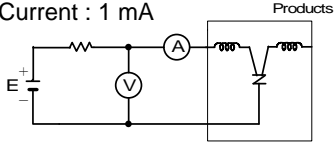
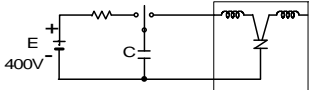
No.	Item	Specification	Test Method												
7.1	Style and Dimension	Meet item 9.	Visual Inspection and measured with Slide Calipers.												
7.2	Marking	Marking is able to be read easily.	Visual Inspection.												
7.3	Capacitance and Tolerance	Meet item 3.	Frequency : 1±0.1kHz Test Voltage : 0.1 V(rms)												
7.4	Insulation Resistance(I.R.)		Test Voltage : 10 V Time : 5±1 minute through a suitable resistor 10kΩ.												
7.5	Varistor Voltage		Measuring Current : 1 mA 												
7.6	Voltage Ratio		Measuring Current : 1 mA , 10mA Measureing circuit : See 7.5 Calculate expression : V_{10}/V_1 V_{10} : Varistor Voltage at 10mA V_1 : Varistor Voltage at 1 mA												
7.7	Characteristic (TC)		Capacitance shall be measured at each step specified in Table 1 after reaching the thermal equilibrium. The capacitance change against the capacitance at step 3 shall be calculated. <u>Table1</u> <table border="1" style="margin-left: 20px;"> <tr> <td>Step</td> <td>1</td> <td>2</td> <td>3</td> <td>4</td> <td>5</td> </tr> <tr> <td>Temp. (°C)</td> <td>+20±2</td> <td>-25±2</td> <td>+20±2</td> <td>+85±2</td> <td>+20±2</td> </tr> </table>	Step	1	2	3	4	5	Temp. (°C)	+20±2	-25±2	+20±2	+85±2	+20±2
Step	1	2	3	4	5										
Temp. (°C)	+20±2	-25±2	+20±2	+85±2	+20±2										
7.8	Temperature Cycle	Meet Table 2. <u>Table 2</u>	1 cycle Step 1 -40°C (+0°C,-3°C) / 30 min. Step 2 Ordinary Temp. / within 5 min. Step 3 +125°C (+3°C,-0°C) / 30 min. Step 4 Ordinary Temp. / within 5 min. Total 10 cycles Then measured after exposure in the room condition for 4 to 24 hours.												
7.9		Humidity		Temperature : 40 ± 2°C Humidity : 90 to 95 %(RH) Time : 500 hours(+12-0 hours) Then measured after exposure in the room condition for 4 to 24hours.											
7.10	Heat Life	Meet Table 3. <u>Table 3</u>	Temperature : 85 ± 3°C Time : 1000 hours(+24-0 hours) Applying Voltage : varistor voltage(V_1 mA) Then measured after exposure in the room condition for 4 to 24hours.												
7.11		Overload		Applying Voltage : 1.4 times varistor voltage(V_1 mA) Time : 5 minutes Circuit : See 7.5											
7.12	Surge(1)		Applying Voltage(E) : 400V(DC) Dump Capacitor(C) : 0.47 μF Interval of Application : ON / OFF 1 second The number of applied times : 10 ⁵ times Then measured after exposure in the room condition for 1 to 2 hours. 												

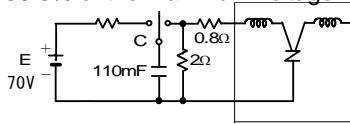
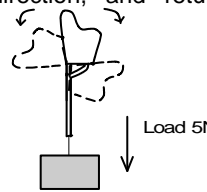
No.	Item	Specification	Test Method
7.13	Surge(2)	Meet Table 3.	<p>Voltage shall be charged to dump capacitor, and then discharged through the specimen.(JASO A-1) The number of applied times : 1 time Decay time constant : 200 ms Decay time constant means the time that the voltage decay to 36.8% of the maximum voltage.</p> 
7.14	ESD test		<p>Energy storage capacitance : 150 pF Discharge resistance : 330Ω Test Voltage : 25kV(DC) Discharge method : Contact discharge The Number of times : 10 times of each polarity Then measured after exposure in the room condition for 4 to 24hours.</p>
7.15	Solderability	Along the circumference of terminal shall be covered with new solder at least 75%.	<p>Flux : Ethanol solution of rosin,25(wt)% (dipped for 5 to 10 seconds) Solder : Sn-3.0Ag-0.5Cu Solder Temperature : 245±5°C Immersion Time : 2 ± 0.5 seconds Immersion Depth : 1 mm from the bottom of the body.</p>
7.16	Resistance to Soldering Heat	Meet Table 2.	<p>Flux : Ethanol solution of rosin,25(wt)% (dipped for 5 to 10 seconds) Solder : Sn-3.0Ag-0.5Cu Solder Temperature : 270 ± 5 °C Immersion Time : 10± 1 seconds Immersion Depth : 1.6 ± 0.8 mm from the bottom of the body. Then measured after exposure in the room condition for 4 to 24hours.</p>
7.17	Vibration	Meet Table 2.	<p>It shall be soldered on the substrate. Range of Vibration Frequency : 10 to 2000 to 10(Hz) / 20 minutes Amplitude : 1.5mm or acceleration (about 196m/s²) Direction of Vibration : 3 perpendicular directions Duration of Vibration : 6 hours (2 hours in each directions)</p>
7.18	Terminal Strength	(Pull Test) It shall be no damaged.	<p>Applying Force : 10N Time : 5±1 seconds.</p>
		(Bend Test) It shall be no damaged.	<p>The load (5N) shall be hung at the tip of the leads. The body of the EMIFIL shall be bent 90° and returned to its original position. And the body shall be bend 90° in the opposite direction, and returned to its original position.</p> 

8.Mounting Hole

Bulk

Taping

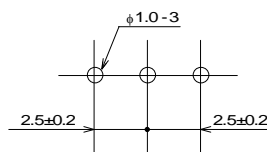
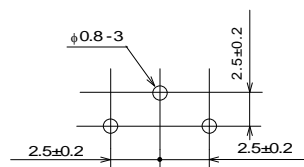

(in mm)

9.Style and Dimension

9.1 Bulk Type

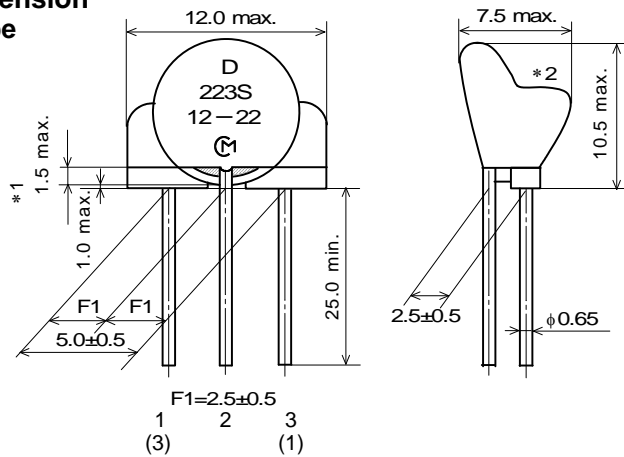

(in mm)

*1 Coating extending on leads does not exceed the tangent line.
Exposed electrode, if any, is covered by solder, etc.

*2 There should not be the exposure of the ferrite bead if a hole is on top of ferrite bead.

9.2 Taping Type

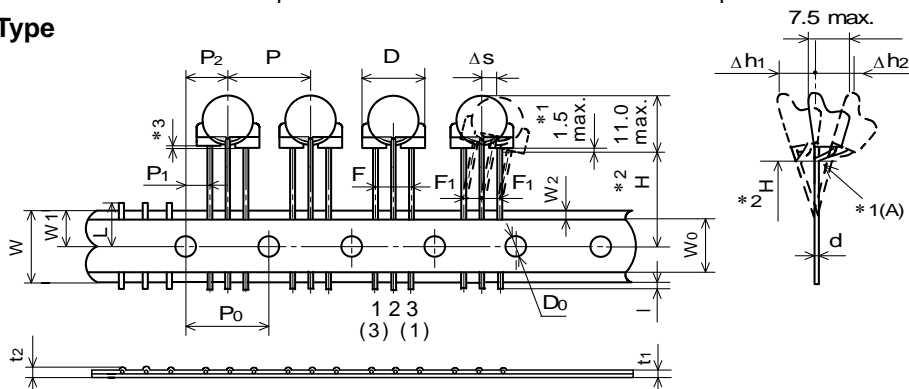

*1. Coating extending on leads does not exceed the start of bend.(Point A).

Exposed electrodes are covered with solder.

*2. H : to be measured from the forming point A .

*3. The deviation between two ferrite beads shall be less than 1.2mm.

Code	Description	Dimensions	Remark
P	Pitch of Component	12.7	Product Inclination ΔS Determines Crossing
P0	Pitch of Sprocket Hole	12.7±0.2	
P1	Length from Hole Center to Lead	3.85±0.7	
P2	Length from Hole Center to Component Center	6.35±1.3	Shift In Tape In Direction of Feed
D	Width of Body	12.0 max.	
ΔS	Deviation along tape, Left or Right	0±1.0	
W	Carrier Tape Width	18.0±0.5	
W1	Position of Sprocket Hole	9.0 +0 / -0.5	Tape Widthwise Shift
l	Protrusion Length	+0.5 ~ -1.0	
D0	Diameter of Sprocket Hole	φ 4.0±0.1	
d	Lead Diameter	φ 0.6	
t1	Total Tape Thickness	0.7±0.2	Includes Thickness of Bonding Tape
t2	Total Thickness, Tape and Lead Wire	1.5 max.	
Δh1	Deviation across Tape, front	1.0 max.	
Δh2	Deviation across Tape, rear	1.0 max.	
L	Portion to Cut in Case of Defect	11.0 +0 / -1.0	
W0	Hold Down Tape Width	12.0±0.5	
W2	Hold Down Tape Position	1.5±1.5	
H	Lead length between sprocket hole and forming position	Q91	20.0±1.0
		Q92	16.5±1.0
		Q93	18.5±1.0
F	Lead Spacing	5.0 +0.8 / -0.2	
F1		2.5 +0.4 / -0.2	

10. Taping

10.1 (1) A maximum of 0.3% of the components quantity per reel or Flat pack may be missing without consecutive missing components.

10.2 The adhesive power of the tape shall have over 2.94N at the following condition.

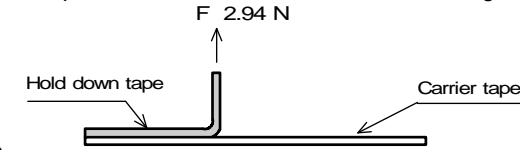

10.3 Splicing method of tape

1. Carrier tape

Carrier tape shall be spliced by cellophane tape. Overall thickness shall be less than 1.05 mm.

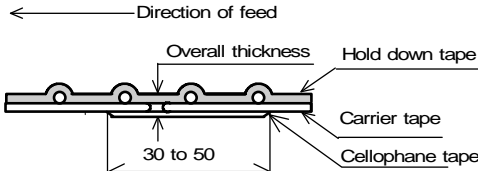

(in mm)

2. Hold down tape

Hold down tape shall be spliced with overlapping. Overall thickness shall be less than 1.05 mm.

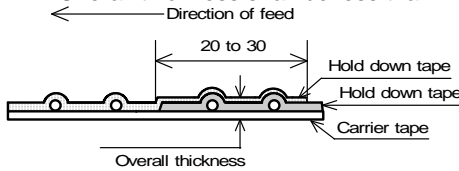

(in mm)

3. Both carrier tape and hold down tape

Both tapes shall be cut zigzag and spliced with splicing tape.

11. Packing

11.1 Packing quantity

Terminal Configuration	A Unit Quantity	Packing Form
Bulk	200 pcs.	In a plastic bag
Taping	800 pcs.	In a reel

* A quantity in a container is depending on a quantity of an order.

11.2 Packing Form

(1) Bulk

<A plastic bag pack>

1. Products are packed into a plastic bag.

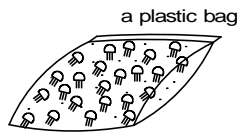

2. The plastic bags are put into a container (corrugated cardboard box) depending on a quantity of an order.

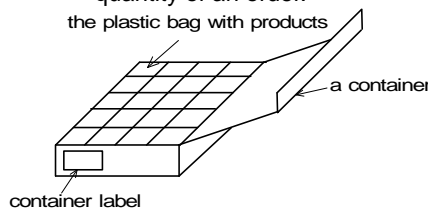

(2) Taping

<A reel>

1. Taped products are loaded in a reel made of corrugated cardboard.
2. The dimensions of the reel and the products orientation are as shown in below.
3. The products loaded in the reel are put into a container (corrugated cardboard box) depending on a quantity of an order.
4. Not less than 3 consecutive of component shall be missing on both edge of tape.

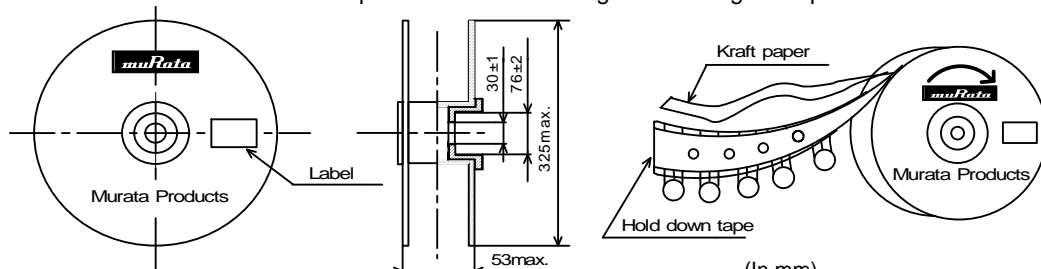

(In mm)

12. Marking on package**12.1 Unit Package**

Bulk : Marked on a plastic bag.

Taping : Marked on a label stuck on a reel.

Marking on a unit package consists of :

Customer part number, MURATA part number, Inspection number(*1), RoHS marking (*2), Quantity, etc

*1) « Expression of Inspection No. » $\square\square$ $\text{O}\text{O}\text{O}\text{O}$ XXX
(1) (2) (3)

(1) Factory Code

(2) Date

First digit : Year / Last digit of year

Second digit : Month / Jan. to Sep. → 1 to 9, Oct. to Dec. → O,N,D

Third, Fourth digit : Day

(3) Serial No.

*2) « Expression of RoHS marking » ROHS - Y (Δ)
(1) (2)

(1) RoHS regulation conformity parts.

(2) MURATA classification number

12.2 Container

Marking on the label stucked on a container consists of :

Customer name Purchasing Order Number, Customer Part Number, MURATA part number,

RoHS marking (*2), Quantity, etc

13.  Caution**13.1 Mounting holes**

Mounting holes should be designed as specified in this specifications. (See item 8.)

Or different design from this specifications may cause cracks in ceramics which may lead to smoking / firing.

13.2 Mounting for P.C.B. (Applied only to bulk type.)

Form of mounting hole is a triangle. (See item 8.)

Product should be inserted and soldered to each holes correct way as Fig.1. (The center terminal and the other terminals become parallel when seeing a product from the side.)

Smoking and firing maybe caused by wrong way like a Fig.2.

(The center terminal and the other terminals cross when seeing a product from the side.)

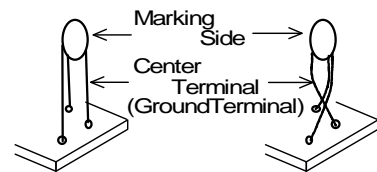

Fig.1 Right Way

Fig.2 Wrong Way

13.3 Terminal Varistor-Capacitor

Products should not be applied for the absorption of surge which have large energy (ex. Included lightning surge, switching surges) because it is designed for the absorption of electrostatic surges.

13.4. Caution for the product angle adjust work

Take care not to apply any mechanical stress to product body at the lead terminal bending process for product angle adjustment after insertion.

13.5 Limitation of Applications

Please contact us before using our products for the applications listed below which require especially high reliability for the prevention of defects which might directly cause damage to the third party's life, body or property.

- | | |
|--|--|
| (1) Aircraft equipment | (7) Traffic signal equipment |
| (2) Aerospace equipment | (8) Disaster prevention / crime prevention equipment |
| (3) Undersea equipment | (9) Data-processing equipment |
| (4) Power plant control equipment | (10) Applications of similar complexity and /or reliability requirements |
| (5) Medical equipment | to the applications listed in the above |
| (6) Transportation equipment (vehicles, trains, ships, etc.) | |

14. Notice**14.1 Soldering**

- (1) Use rosin-based flux. Do not use strong acidic flux with halide content exceeding 0.2(wt)% (chlorine conversion value).
Use Sn-3.0Ag-0.5Cu solder

- (2) Standard flow soldering profile.

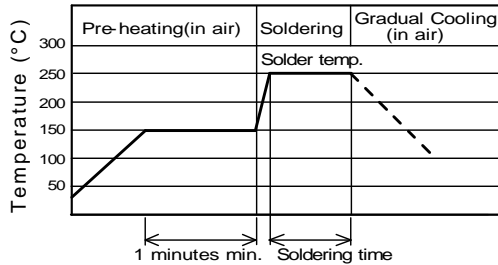

Solder temperature	Soldering time
250~260 °C	4~6s

- (3) Resistance to soldering iron goes in the following condition that tip temperature is 350 °C max. and soldering time is 5 s max.
(4) Products and the leads should not be subject to any mechanical stress during soldering process. (and also while subject to the equivalent high temperature.)

14.2 Cleaning

Products shall be cleaned on following conditions.

- (1) Cleaning Temperature: 60°C max.(40°C max. for Isopropyl alcohol).
(2) Ultrasonic cleaning shall comply with the following conditions, avoiding the resonance phenomenon at the mounted products and P.C.B.
Power : 20W / l max. Frequency : 28kHz ~ 40kHz Time : 5 minutes max.
(3) Cleaning agent
1. alcohol cleaning agents.
 • Isopropyl alcohol (IPA)
2. Aqueous cleaning agent
 • Pine Alpha ST-100S
(4) Ensure that residual flux and residual cleaning agent is completely removed.
 Products should be thoroughly dried after aqueous agent has been removed with de-ionized water.
(5) For other cleaning methods, please contact Murata engineering.

14.3 Operating Environment

- (1) Do not use products in corrosive gases such as chlorine gas, acid or sulfide gas.
(2) Do not use products in the environment where water, oil or organic solvents may adhere to products.
(3) Do not adhere any resin to products, coat nor mold products with any resin (including adhesive) to prevent mechanical and chemical stress on products.

14.4 Storage and handling requirements

- (1) Storage period
 Use the products within 12 months after delivered.
 Solderability should be checked if this period is exceeded.
(2) Storage environment condition
 To prevent products quality deterioration, storage conditions should be controlled as follows ;
1. Temperature : -10 to 40 degrees centigrade
2. Humidity : 15 to 85% relative humidity
3. Products should be stored without sudden changes in temperature and humidity.
 Don't keep products in corrosive gases such as sulfur, chlorine gas or acid,
 or it may cause oxidization of lead terminals resulting in poor solderability.
4. Products should be stored on the palette for the prevention of the influence from humidity, dust and so on.
5. Products should be stored in the warehouse without heat shock, vibration, direct sunlight and so on.
(3) Handling Conditions
 Care should be taken when transporting or handling product to avoid excessive vibration or mechanical shock.

15.  Note

- (1) Please make sure that your product has been evaluated in view of your specifications with our product being mounted to your product.
(2) You are requested not to use our product deviating from the reference specifications.
(3) The contents of this reference specification are subject to change without advance notice. Please approve our product specifications or transact the approval sheet for product specifications before ordering.