



9.8 mΩ Nanopower Mobile 6.0 A Load Switch with Discharge

General Description

The SLG5NT1477V is a 9.8 mΩ 6.0 A single-channel load switch that is able to switch 0.85 to 3.3 V power rails. The product is packaged in an ultra-small 1.5 x 2.0 mm package.

Features

- 1.5 x 2.0 mm FC-TDFN 9L package (2 fused pins for drain and 2 fused pins for source)
- Logic level ON pin capable of supporting 0.85 V CMOS Logic
- Discharged Load when off
- Fast Turn On time
- Low RDS_{ON} while supporting 6.0 A
- Pb-Free / Halogen-Free / RoHS compliant
- Operating Temperature: -40 °C to 85°C
- Operating Voltage: 3.0 V to 5.25 V

Pin Configuration

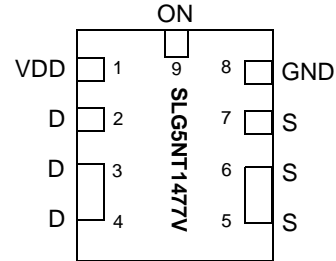

**9-pin FC-TDFN
(Top View)**

Applications

- Watch Power Rail Switching
- Tablet Power Rail Switching
- Smartphone Power Rail Switching
- Notebook Power Rail Switching

Block Diagram

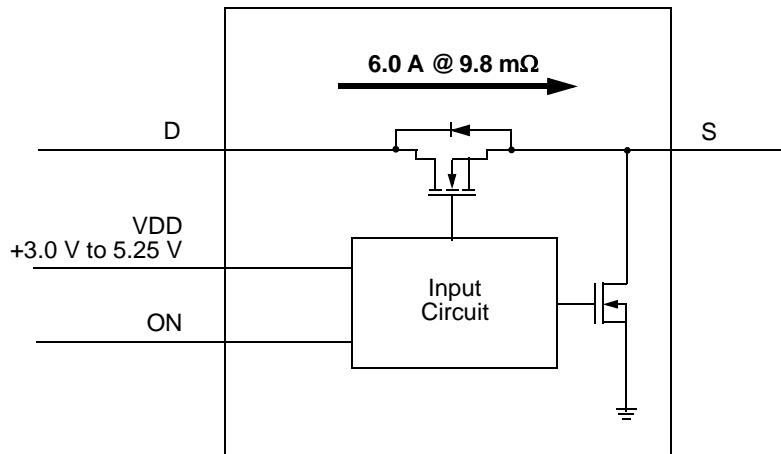



Pin Description

Pin #	Pin Name	Type	Pin Description
1	VDD	PWR	VDD power for load switch control (3.0 V to 5.25 V)
2	D	MOSFET	Drain of Power MOSFET
3	D	MOSFET	Drain of Power MOSFET (fused with pin 4)
4	D	MOSFET	Drain of Power MOSFET (fused with pin 3)
5	S	MOSFET	Source of Power MOSFET (fused with pin 6)
6	S	MOSFET	Source of Power MOSFET (fused with pin 5)
7	S	MOSFET	Source of Power MOSFET
8	GND	GND	Ground
9	ON	Input	Turns MOSFET ON (4 MΩ pull down resistor) CMOS input with VIL < 0.2 V, VIH > 0.85 V

Ordering Information

Part Number	Type	Production Flow
SLG5NT1477V	FC-TDFN 9L	Industrial, -40 °C to 85 °C
SLG5NT1477VTR	FC-TDFN 9L (Tape and Reel)	Industrial, -40 °C to 85 °C

SLG5NT1477V RDS_{ON}

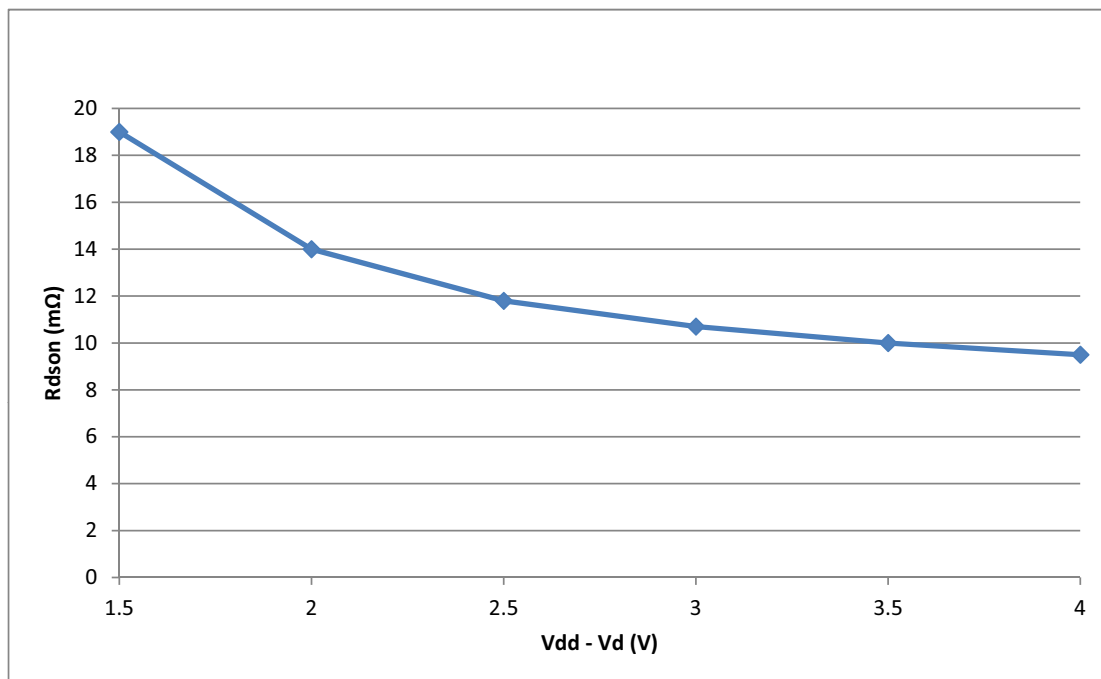



Absolute Maximum Ratings

Parameter	Description	Conditions	Min.	Typ.	Max.	Unit
V_{DD}	Power Supply		--	--	7	V
T_S	Storage Temperature		-65	--	150	°C
ESD_{HBM}	ESD Protection	Human Body Model	2000	--	--	V
MSL	Moisture Sensitivity Level		1			
W_{DIS}	Package Power Dissipation		--	--	1.0	W
MOSFET $I_{DS_{PK}}$	Peak Current from Drain to Source	For no more than 1 ms with 1% duty cycle	--	--	9	A

Note: Stresses greater than those listed under "Absolute Maximum Ratings" may cause permanent damage to the device. This is a stress rating only and functional operation of the device at these or any other conditions above those indicated in the operational sections of this specification is not implied. Exposure to absolute maximum rating conditions for extended periods may affect reliability.

Electrical Characteristics

$T_A = -40$ to 85 °C (unless otherwise stated)

Parameter	Description	Conditions	Min.	Typ.	Max.	Unit
V_{DD}	Power Supply Voltage	-40 to 85°C	3.0	--	5.25	V
I_{DD}	Power Supply Current (PIN 1) ¹	when OFF @ 25°C	--	30	60	nA
		when ON, No load, ON Input level = V_{DD} @ 25°C	--	35	70	nA
		when OFF @ 70°C	--	100	900	nA
		when ON, No load, ON Input level = V_{DD} @ 70°C	--	200	900	nA
$R_{DS_{ON}}$	Static Drain to Source ON Resistance	T_A 25°C @ 300 mA, $V_{DD} - V_D = 1.5$ V	--	16.2	18.6	mΩ
		T_A 25°C @ 300 mA, $V_{DD} - V_D = 2.0$ V	--	11.5	13.2	mΩ
		T_A 25°C @ 300 mA, $V_{DD} - V_D = 2.5$ V	--	9.5	10.9	mΩ
		T_A 25°C @ 300 mA, $V_{DD} - V_D = 3.0$ V	--	8.5	9.8	mΩ
		T_A 25°C @ 300 mA, $V_{DD} - V_D = 3.5$ V	--	7.9	9.1	mΩ
		T_A 25°C @ 300 mA, $V_{DD} - V_D = 4.0$ V	--	7.4	8.5	mΩ
$R_{DS_{ON}}$	Static Drain to Source ON Resistance	T_A 70°C @ 300 mA, $V_{DD} - V_D = 1.5$ V	--	19.2	22.1	mΩ
		T_A 70°C @ 300 mA, $V_{DD} - V_D = 2.0$ V	--	14.1	16.2	mΩ
		T_A 70°C @ 300 mA, $V_{DD} - V_D = 2.5$ V	--	11.7	13.5	mΩ
		T_A 70°C @ 300 mA, $V_{DD} - V_D = 3.0$ V	--	10.5	12.1	mΩ
		T_A 70°C @ 300 mA, $V_{DD} - V_D = 3.5$ V	--	9.7	11.2	mΩ
		T_A 70°C @ 300 mA, $V_{DD} - V_D = 4.0$ V	--	9.2	10.6	mΩ
$R_{DS_{ON}}$	Static Drain to Source ON Resistance	T_A 85°C @ 300 mA, $V_{DD} - V_D = 1.5$ V	--	24.96	28.73	mΩ
		T_A 85°C @ 300 mA, $V_{DD} - V_D = 2.0$ V	--	18.33	21.06	mΩ
		T_A 85°C @ 300 mA, $V_{DD} - V_D = 2.5$ V	--	15.21	17.55	mΩ
		T_A 85°C @ 300 mA, $V_{DD} - V_D = 3.0$ V	--	13.65	15.73	mΩ
		T_A 85°C @ 300 mA, $V_{DD} - V_D = 3.5$ V	--	12.61	14.56	mΩ
		T_A 85°C @ 300 mA, $V_{DD} - V_D = 4.0$ V	--	11.96	13.78	mΩ
IDS	Operating Current	$V_D = 1.0$ V to 3.3 V	--	--	6.0	A
V_D	Drain Voltage		0.85	--	$V_{DD} - 1.5$	V



T_A = -40 to 85 °C (unless otherwise stated)

Parameter	Description	Conditions	Min.	Typ.	Max.	Unit
T _{Total_ON}	Total Turn On Time	50% ON to 90% V _S , V _{DD} = 5.25 V, V _D = 1.0 V, C _{LOAD} = 10 μF, R _{LOAD} = 20 Ω	7	9	12	μs
		50% ON to 90% V _S , V _{DD} = 5.25 V, V _D = 1.0 V, C _{LOAD} = 2 μF, R _{LOAD} = 20 Ω	8	10	12	μs
		50% ON to 90% V _S , V _{DD} = 5 V, V _D = 1.0 V, C _{LOAD} = 2 x (50 μF + 2.2 μH Inductor) ²	30	42	50	μs
V _{OUT(SR)}	V _{OUT} Slew Rate	10% V _S to 90% V _S , V _{DD} = 5.25 V, V _D = 1.0 V, C _{LOAD} = 10 μF, R _{LOAD} = 20 Ω	130	160	190	V/ms
		10% V _S to 90% V _S , V _{DD} = 5.25 V, V _D = 1.0 V, C _{LOAD} = 2 μF, R _{LOAD} = 20 Ω	150	176	200	V/ms
		10% V _S to 90% V _S , V _{DD} = 5 V, V _D = 1.0 V, R _{LOAD} = 20 Ω, C _{LOAD} = 2 x (50 μF + 2.2 μH Inductor) ²	20	26	35	V/ms
C _{LOAD}	Output Load Capacitance	C _{LOAD} connected from S to GND	--	--	10	μF
R _{DIS}	Discharge Resistance		100	180	300	Ω
ON_V _{IH}	High Input Voltage on ON pin		0.85	--	V _{DD}	V
ON_V _{IL}	Low Input Voltage on ON pin		-0.3	0	0.2	V
T _{OFF_Delay}	OFF Delay Time	50% ON to V _S Fall, V _{DD} = 5.25 V, V _D = 1.0 V, R _{LOAD} = 20 Ω, no C _{LOAD}	--	--	60	μs
T _{FALL}	V _S Fall Time	90% V _S to 10% V _S , V _{DD} = 5.25 V, V _D = 1.0 V, R _{LOAD} = 20 Ω, no C _{LOAD}	--	15	--	μs

Notes:
1. Guaranteed by design and characterization
2. See Application Diagram below regarding C_{LOAD} = 2 x (50 μF + 2.2 μH).

Application Diagram (Source loading > 10 μF)

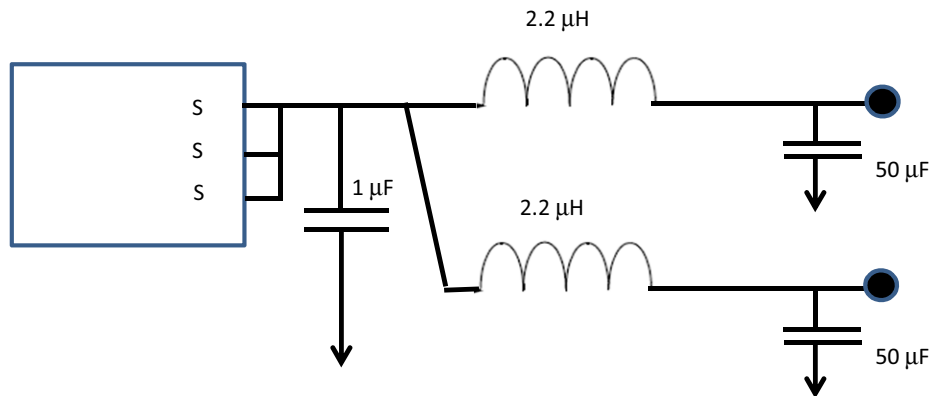

Capacitive loads > 10 μF directly on the S pin may result in nonlinear output ramping. In cases where > 10 μF load capacitance is required, we recommend decoupling the load(s) with 2.2 μH inductors while putting a 1 μF capacitor on V_S as shown above in order to guarantee linear ramping and inrush current limiting.



T_{Total_ON} , T_{ON_Delay} and Slew Rate Measurement

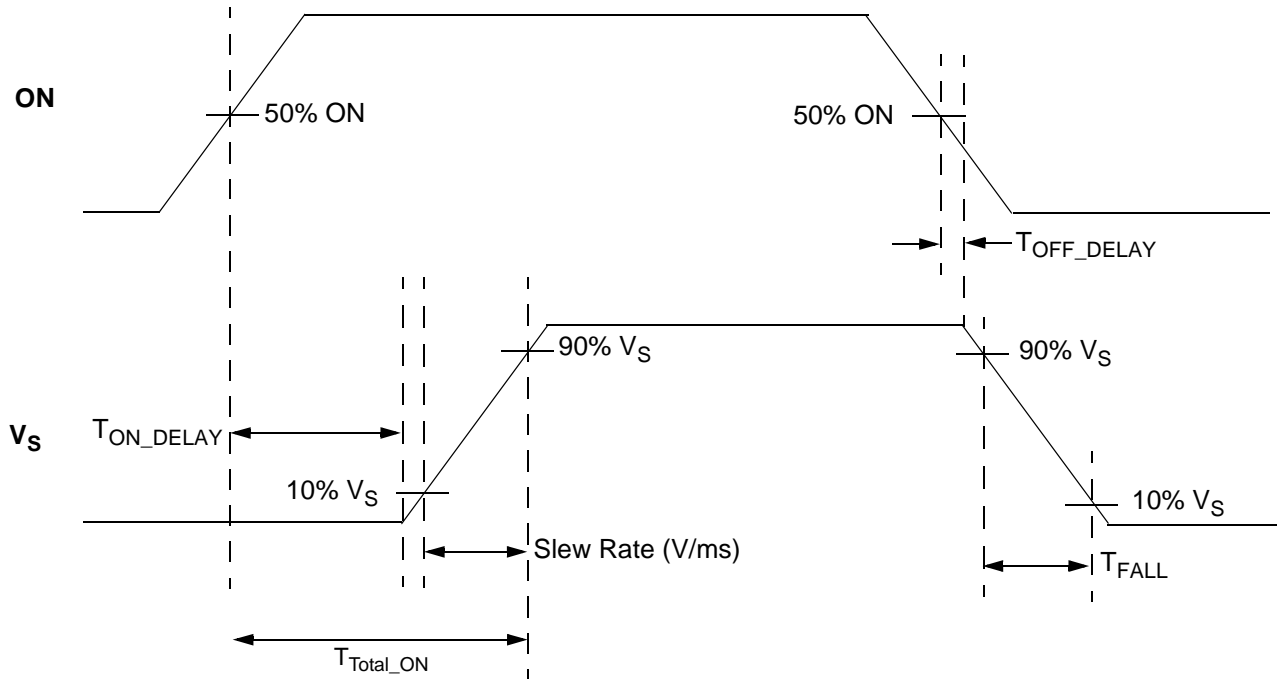

SLG5NT1477V Layout Suggestion

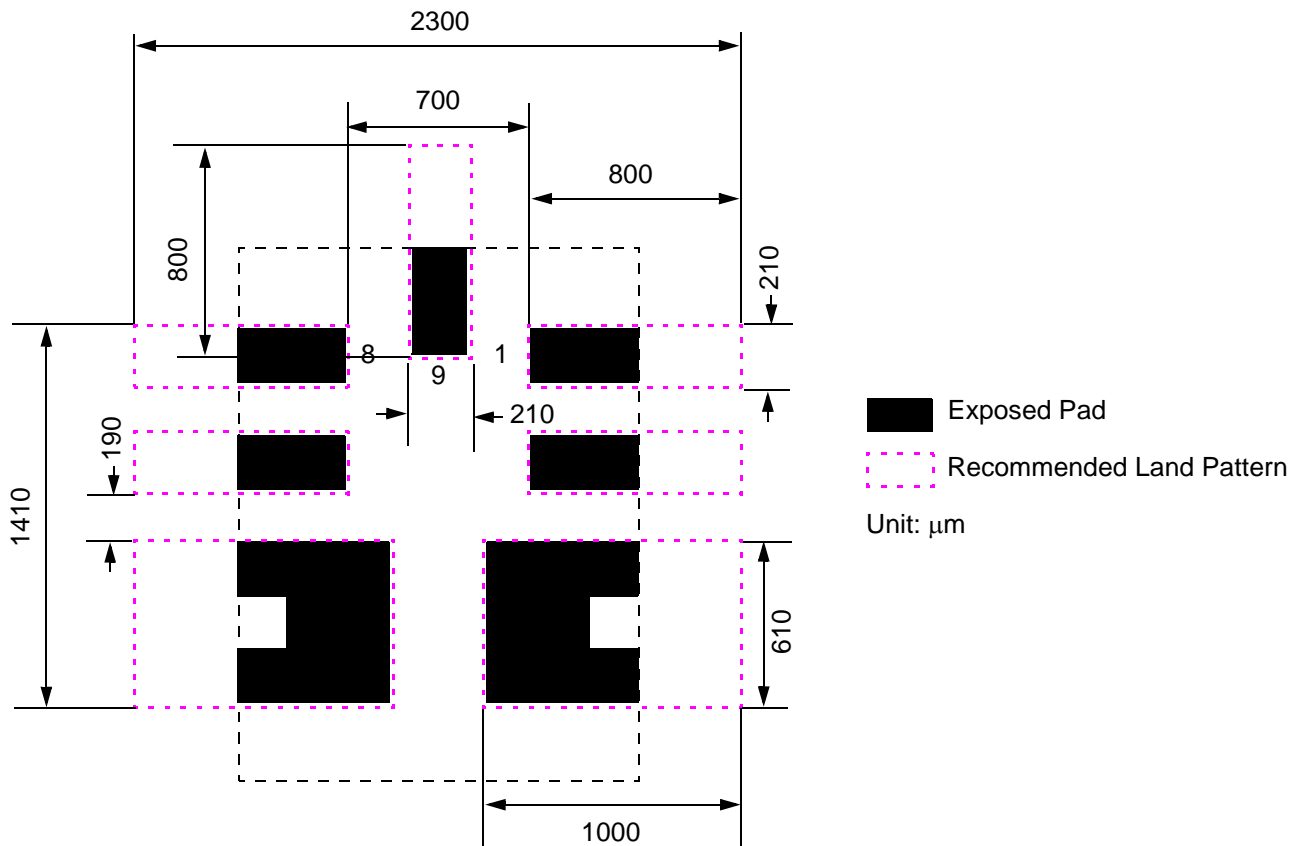



Package Top Marking System Definition

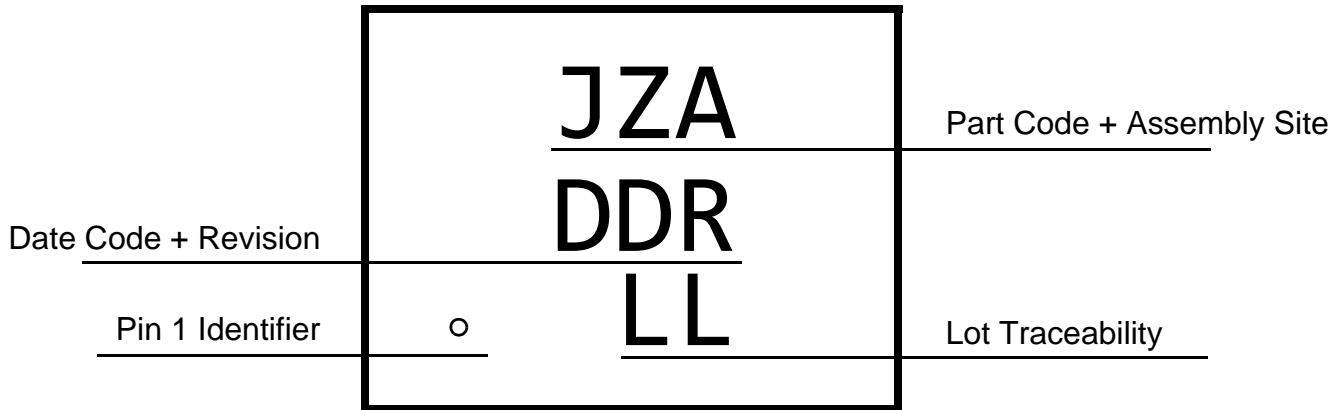

- JZ - Part Code
- A - Assembly Site Code Field²
- DD - Date Code Field¹
- R - Part Revision Code Field²
- LL - Lot Traceability Field¹

Note 1: Each character in code field can be alphanumeric A-Z and 0-9

Note 2: Character in code field can be alphabetic A-Z



Package Drawing and Dimensions

9 Lead TDFN FC Package 1.5 x 2.0 mm (Fused Lead)
JEDEC MO-252, Variation W2015D

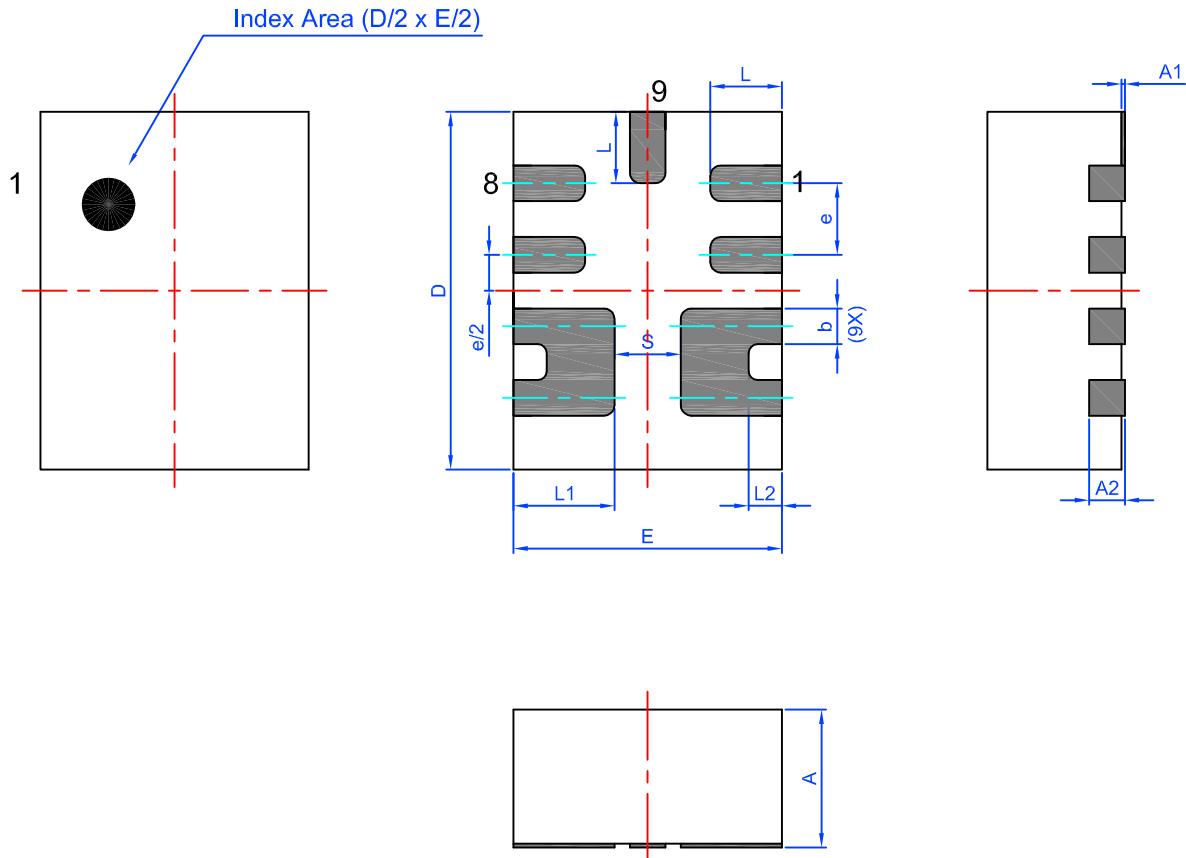

Unit: mm

Symbol	Min	Nom.	Max	Symbol	Min	Nom.	Max
A	0.70	0.75	0.80	L	0.35	0.40	0.45
A1	0.005	-	0.060	L1	0.515	0.565	0.615
A2	0.15	0.20	0.25	L2	0.135	0.185	0.235
b	0.15	0.20	0.25	e	0.40 BSC		
D	1.95	2.00	2.05	S	0.37 REF		
E	1.45	1.50	1.55				



Tape and Reel Specifications

Package Type	# of Pins	Nominal Package Size [mm]	Max Units		Reel & Hub Size [mm]	Leader (min)		Trailer (min)		Tape Width [mm]	Part Pitch [mm]
			per Reel	per Box		Pockets	Length [mm]	Pockets	Length [mm]		
TDFN 9L FC Green	9	1.5 x 2.0 x 0.75	3000	3000	178 / 60	100	400	100	400	8	4

Carrier Tape Drawing and Dimensions

Package Type	Pocket BTM Length	Pocket BTM Width	Pocket Depth	Index Hole Pitch	Pocket Pitch	Index Hole Diameter	Index Hole to Tape Edge	Index Hole to Pocket Center	Tape Width
	A0	B0	K0	P0	P1	D0	E	F	W
TDFN 9L FC Green	1.68	2.18	0.9	4	4	1.5	1.75	3.5	8

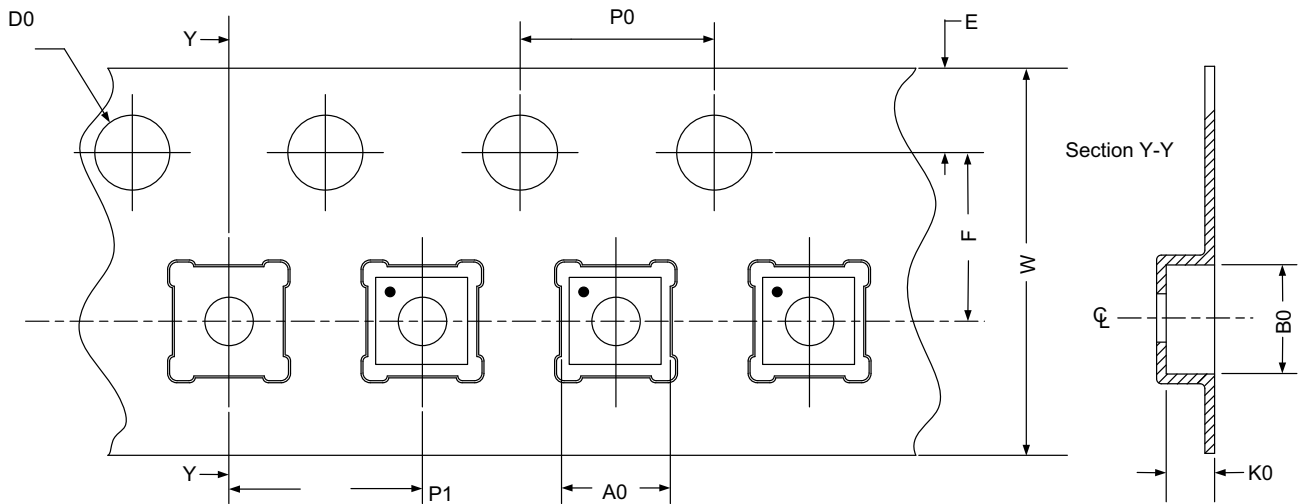

Refer to EIA-481 specification

Recommended Reflow Soldering Profile

Please see IPC/JEDEC J-STD-020: latest revision for reflow profile based on package volume of 2.25 mm³ (nominal). More information can be found at www.jedec.org.



Revision History

Date	Version	Change
9/8/2016	1.26	Updated T_{Total_ON} , $V_{OUT(SR)}$, T_{OFF_Delay} , T_{FALL} specs Updated Application Diagram Notes Updated Formating and Parameter Names for clarity
4/26/2016	1.25	Added MSL 1 Added Part Code Marking Information
9/04/2015	1.24	Fixed T_A conditions in Electrical Characteristics