



Is Now Part of



**ON Semiconductor®**

To learn more about ON Semiconductor, please visit our website at

[www.onsemi.com](http://www.onsemi.com)

ON Semiconductor and the ON Semiconductor logo are trademarks of Semiconductor Components Industries, LLC dba ON Semiconductor or its subsidiaries in the United States and/or other countries. ON Semiconductor owns the rights to a number of patents, trademarks, copyrights, trade secrets, and other intellectual property. A listing of ON Semiconductor's product/patent coverage may be accessed at [www.onsemi.com/site/pdf/Patent-Marking.pdf](http://www.onsemi.com/site/pdf/Patent-Marking.pdf). ON Semiconductor reserves the right to make changes without further notice to any products herein. ON Semiconductor makes no warranty, representation or guarantee regarding the suitability of its products for any particular purpose, nor does ON Semiconductor assume any liability arising out of the application or use of any product or circuit, and specifically disclaims any and all liability, including without limitation special, consequential or incidental damages. Buyer is responsible for its products and applications using ON Semiconductor products, including compliance with all laws, regulations and safety requirements or standards, regardless of any support or applications information provided by ON Semiconductor. "Typical" parameters which may be provided in ON Semiconductor data sheets and/or specifications can and do vary in different applications and actual performance may vary over time. All operating parameters, including "Typicals" must be validated for each customer application by customer's technical experts. ON Semiconductor does not convey any license under its patent rights nor the rights of others. ON Semiconductor products are not designed, intended, or authorized for use as a critical component in life support systems or any FDA Class 3 medical devices or medical devices with a same or similar classification in a foreign jurisdiction or any devices intended for implantation in the human body. Should Buyer purchase or use ON Semiconductor products for any such unintended or unauthorized application, Buyer shall indemnify and hold ON Semiconductor and its officers, employees, subsidiaries, affiliates, and distributors harmless against all claims, costs, damages, and expenses, and reasonable attorney fees arising out of, directly or indirectly, any claim of personal injury or death associated with such unintended or unauthorized use, even if such claim alleges that ON Semiconductor was negligent regarding the design or manufacture of the part. ON Semiconductor is an Equal Opportunity/Affirmative Action Employer. This literature is subject to all applicable copyright laws and is not for resale in any manner.

User Guide for  
FEBFAN6863W\_CP452v1  
Evaluation Board

Highly Integrated Green-Mode PWM  
Controller FAN6863W  
19 V / 2.1 A Notebook Adapter

Featured Fairchild Product:  
FAN6863W

***Direct questions or comments  
about this evaluation board to:  
“Worldwide Direct Support”***

**[Fairchild Semiconductor.com](http://Fairchild Semiconductor.com)**

## Table of Contents

1. Introduction.....	4
1.1. Description .....	4
1.2. Features .....	4
2. Evaluation Board Specifications.....	5
3. Photographs.....	6
4. Printed Circuit Board .....	7
5. Schematic.....	8
6. Bill of Materials .....	9
7. Test Conditions & Test Equipment.....	10
8. Input Current.....	11
8.1. Test Condition .....	11
9. Input Wattage at No-load Condition.....	11
9.1. Test Condition .....	11
9.2. Measured Waveforms .....	11
<b>10. Turn-On Time .....</b>	<b>12</b>
<b>10.1. Test Condition .....</b>	<b>12</b>
<b>11. Hold-up Time.....</b>	<b>12</b>
<b>11.1. Test Condition .....</b>	<b>12</b>
11.2. Measured Waveform .....	12
12. DC Output Rising Time .....	13
12.1. Test Condition .....	13
12.2. Measured Waveform .....	13
13. Line & Load Regulation .....	14
13.1. Test Condition .....	14
14. Efficiency .....	14
14.1. Test Condition .....	14
15. Output Ripple & Noise .....	16
15.1. Test Condition .....	16
15.2. Measured Waveform .....	16
16. Step Response .....	17
16.1. Test Condition .....	17
16.2. Measured Waveform .....	17

17. Over-Current Protection (OCP) .....	18
17.1. Test Condition .....	18
18. Short-Circuit Protection .....	18
18.1. Test Condition .....	18
18.2. Measured Waveform (Output-Short Condition) .....	18
19. Brownout Test .....	19
19.1. Test Condition .....	19
20. V <sub>DD</sub> Voltage Level .....	19
20.1. Measured Waveform .....	19
21. Voltage Stress on MOSFET & Rectifiers .....	20
21.1. Test Condition .....	20
21.2. Measured Waveform .....	20
21.3. Electromagnetic Interference (EMI) Test .....	21
22. Surge Test .....	22
23. ESD Test .....	22
24. Revision History .....	28

This user guide supports the evaluation kit for the FAN6863W. This FEBFAN6863W\_CP452v1 evaluation board can be identified by the silkscreen marking PLM0068 REV:1 on the bottom side of the PCB. It should be used in conjunction with the FAN6863W datasheet as well as Fairchild's application notes and technical support team. Please visit Fairchild's website at [www.fairchildsemi.com](http://www.fairchildsemi.com).

## 1. Introduction

This document describes a 40 W power supply using the FAN6863W.

### 1.1. Description

The operating current in FAN6863W is as small as 3 mA. The small operating current results in higher efficiency and reduces the  $V_{DD}$  hold-up capacitance requirement. Once FAN6863W enter “deep” Green Mode, the operating current is reduced to 0.6 mA, assisting the power supply in meeting power conservation requirements.

By using FAN6863W, an adapter can be implemented with few external components and minimized cost.

### 1.2. Features

- Low Standby Power: Under 0.1 W
- Low Startup Current: 8  $\mu$ A
- Low Operating Current in Green Mode: 600  $\mu$ A
- Peak-Current Mode Operation with Cycle-by-Cycle Current Limiting
- PWM Frequency Continuously Decreasing with Burst Mode at Light Loads
- $V_{DD}$  Over-Voltage Protection (OVP)
- Constant Output Power Limit (Full AC Input Range)
- Internal Latch Circuit (FAN6863WL) for OVP, OTP
- SENSE Pin Short-Circuit Protection (SSCP)
- Fixed PWM Frequency (65 KHz) with Frequency Hopping
- Feedback Open-Loop Protection: 60 ms Delay
- GATE Output Maximum Voltage Clamp: 13.5 V
- Soft-Start Time: 5 ms
- Soft Driving for EMI Improvement
- Full-Range Frequency Hopping
- Internal OTP Sensor with Hysteresis
- Gate Driving Capability: 400 mA

## 2. Evaluation Board Specifications

**Table 1. Summary of Features and Performance**

All result is tested with output DC cable, AWG 18, 1.8 M.

Specification	Min.	Max.	Unit
<b>Input</b>			
Voltage	90	264	V <sub>AC</sub>
Frequency	47	63	Hz
<b>Output</b>			
Output Voltage 1		19	V
Output Current 1	0	2.1	A
<b>Total Output Power</b>			
Full-load Output Power	0	40	W

### 3. Photographs



Figure 1. Top View

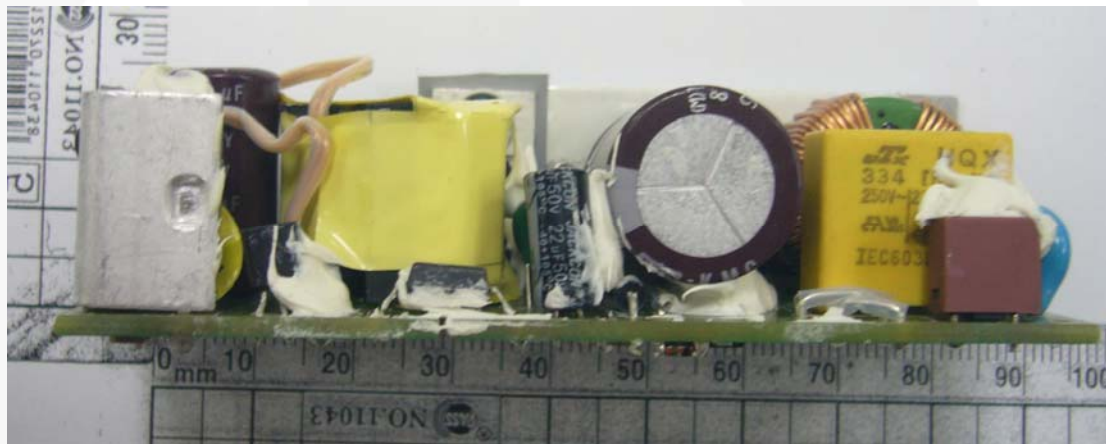


Figure 2. Bottom View

## 4. Printed Circuit Board

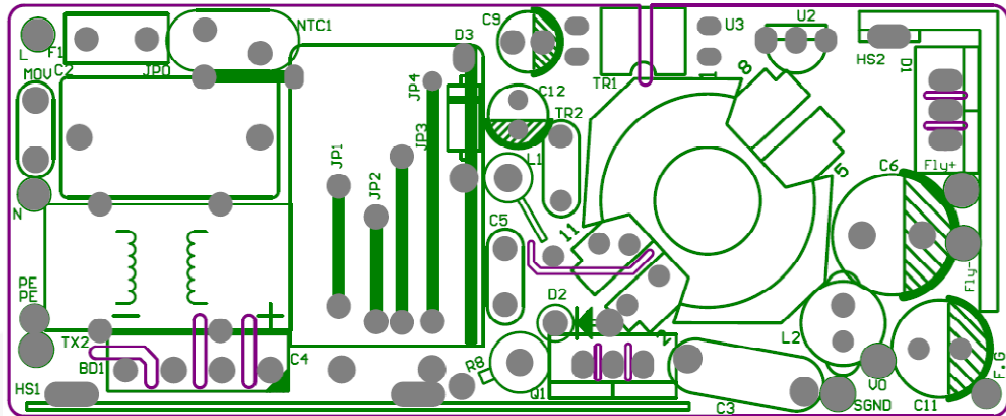


Figure 3. Top Overlay

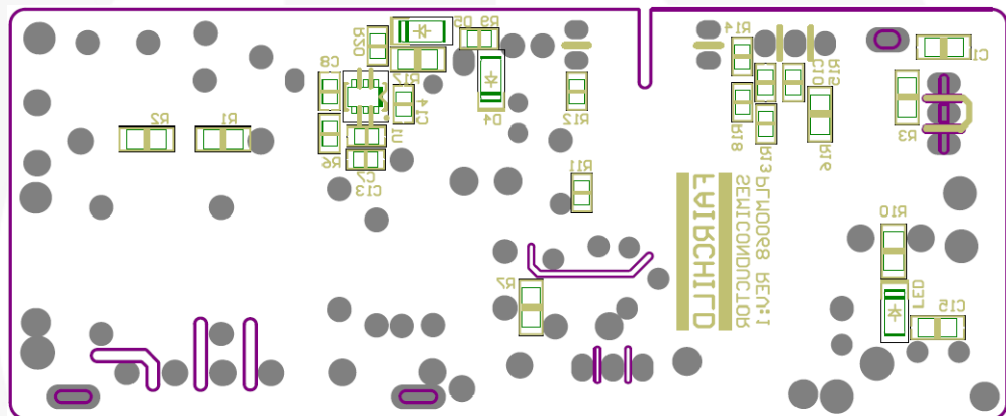


Figure 4. Bottom Overlay

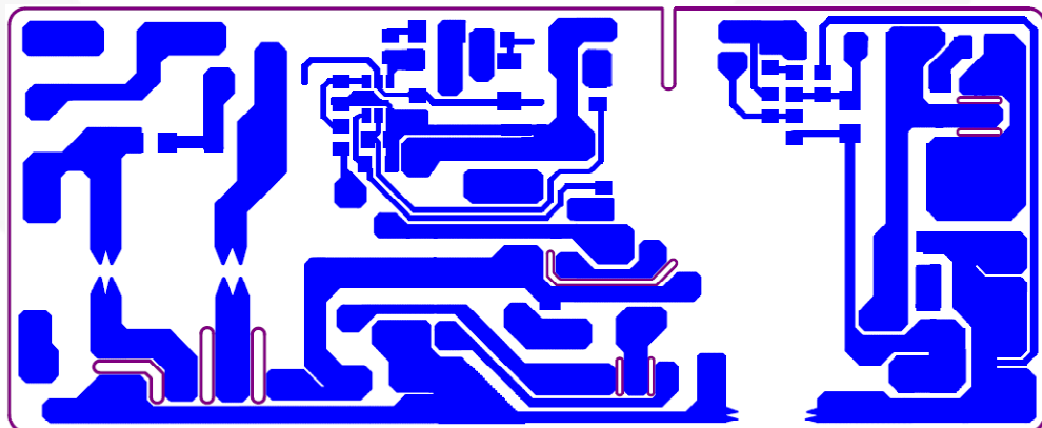
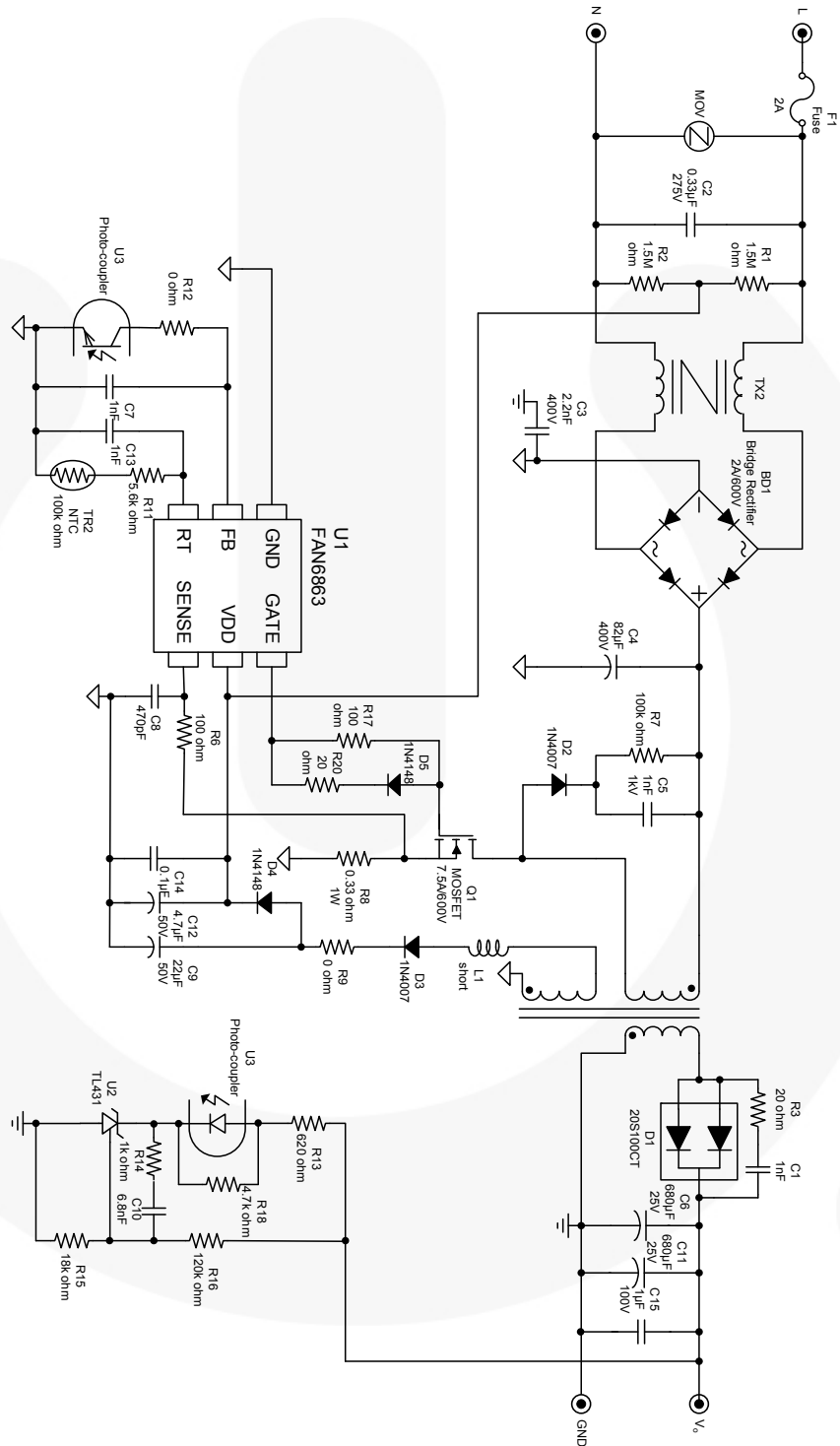


Figure 5. Bottom Layer



## 5. Schematic



**Figure 6. Evaluation Board Schematic**

## 6. Bill of Materials

Part Type	Qty.	Part No.	Manufacturer	Designator
JUMPER WIRE 0.8ψ(mm)	8			JP0~JP4, NTC1, L1, L2
Metal-Oxide Resistor 1 W 0.33 Ω ±10%	1			R8
SMD Resistor 0805 0 Ω ±%	1			R9, R12
SMD Resistor 0805 20 Ω ±5%	1			R20
SMD Resistor 0805 100 Ω ±5%	2			R6
SMD Resistor 0805 620 Ω ±5%	1			R13
SMD Resistor 0805 1 kΩ ±5%	1			R14
SMD Resistor 0805 5.6 kΩ ±5%	1			R11
SMD Resistor 0805 18 kΩ ±5%	1			R15
SMD Resistor 0805 47 kΩ ±5%	1			R18
SMD Resistor 1206 20 Ω ±5%	1			R3
SMD Resistor 1206 100 Ω ±5%	1			R17
SMD Resistor 1206 100 kΩ ±5%	1			R7
SMD Resistor 1206 120 kΩ ±5%	1			R16
SMD Resistor 1206 1.5 MΩ ±5%	2			R1, R2
0805 X7R +/-10% 1 nF 50 V	2			C7, C13
0805 X7R +/-10% 470 pF 50 V	1			C8
0805 X7R +/-10% 6.8 nF 50 V	1			C10
0805 X7R +/-10% 0.1 μF 50 V	1			C14
1206 X7R +/-10% 1 nF 100 V	1			C1
1206 X7R +/-10% 1 μF 100 V	1			C15
Ceramic Capacitor 1 nF 1K V	1			C5
Electrolytic Capacitor 82 μF 400 V 105°C	1	KMG	NCC	C4
Electrolytic Capacitor 680 μF 25 V 105°C	1	KY	NCC	C6
Electrolytic Capacitor 22 μF 50 V 105°C	1	LHK	Jackcon	C9
Electrolytic Capacitor 680 μF 25 V 105°C	1	LHK	Jackcon	C11
Electrolytic Capacitor 4.7 μF 50 V 105°C	1	LHK	Jackcon	C12
X2 Capacitor 0.33 μF 275 V ±10%	1			C2
Y1 Capacitor 2.2 nF 250 V ±20%	1			C3
MOV Oxide Varistor 471	1			MOV
Common choke 30 mH ±10%	1	TRN0279	SEN HUEI	TX2
Transformer RM-8 L=920 μH	1	TRN0280	SEN HUEI	TR1
FUSE MICRO RST 250 V / 2 A Time-Lag	1		Walter	F1
NTC Resistor 100 kΩ	1	TTC104	Thinking	TR2
SMD Diode 1 A / 1000 V SOD-80	2	LL4148	Fairchild Semiconductor	D4, D5
Diode 1A/700V DO-41	2	1N4007	Fairchild Semiconductor	D2, D3
Bridge Rectifier 2 A / 600 V	1	2KBP06M	Fairchild Semiconductor	BD1
Schottky Diode 20 A / 100 V TO-220	1	YM20S100CT	Fairchild Semiconductor	D1
MOSFET 7.5 A/600 V TO-220	1	FQP8N60C	Fairchild Semiconductor	Q1
REGULATOR ±% TO-92	1	FAN431ACZ-AP	Fairchild Semiconductor	U2
Photo Coupler DIP	1	FOD817A	Fairchild Semiconductor	U3
PWM Controller SSOT-6	1	FAN6863W	Fairchild Semiconductor	U1
Heat Sink 55X20X1.5 mm	1	MCH0636		HS1
Heat Sink 11.5X24.9(L)X17(H)X1.5(W) mm	1	MCH0637		HS2
PCB PLM0068 REV0	1			

## 7. Test Conditions & Test Equipment

**Table 2. Test Conditions & Test Equipment**

Test Temperature	Ambient
<b>Test Equipment</b>	AC Source: 6810 AC POWER SOURCE (MG-0010) Electronic Load: Chroma 63102 (MG-0081) Power Meter: BM817 (MG-0011) Oscilloscope: LeCory 423 (MG-0008)
<b>Test Items</b>	<ol style="list-style-type: none"> <li>1. Input Current</li> <li>2. Input Wattage at No Load Condition</li> <li>3. Turn On Time</li> <li>4. Hold Up Time</li> <li>5. DC Output Rising Time</li> <li>6. Line &amp; Load Regulation</li> <li>7. Efficiency</li> <li>8. Output Ripple &amp; Noise</li> <li>9. Step Response</li> <li>10. Over-Current Protection</li> <li>11. Short-Circuit Protection</li> <li>12. Brownout Test</li> <li>13. V<sub>DD</sub> Voltage Level</li> <li>14. Voltage Stress on MOSFET &amp; Rectifiers</li> <li>15. EMI Test</li> </ol>

## 8. Input Current

### 8.1. Test Condition

Measure the AC input current at maximum loading.

**Table 3. Test Result**

Input Voltage	Input Current (mA)
90 V / 60 Hz	824
264 V / 50 Hz	359

## 9. Input Wattage at No-load Condition

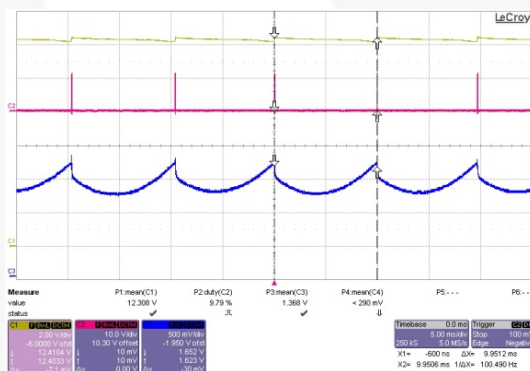
### 9.1. Test Condition

Measure the input wattage and output voltage at no load.

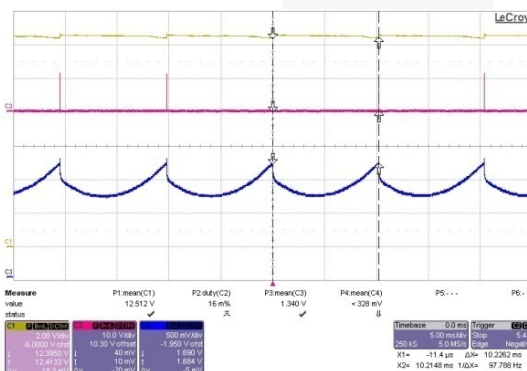
**Table 4. Test Result**

Input Voltage	Input Wattage (mW)	Output Voltage(V)	Specification
90 V / 60Hz	34	19.28	<0.3W
115 V / 60 Hz	37	19.28	
230 V / 50 Hz	68	19.28	
264 V / 50 Hz	81	19.28	
90 V / 60 Hz	34	19.28	

### 9.2. Measured Waveforms



**Figure 7. 90 V / 60 Hz at No Load, Ch1: V<sub>DD</sub>, Ch2: V<sub>GATE</sub>, Ch3: FB**



**Figure 8. 264 V / 50 Hz at No Load, Ch1: V<sub>DD</sub>, Ch2: V<sub>GATE</sub>, Ch3: FB**

## 10. Turn-On Time

### 10.1. Test Condition

Set the output at maximum loading. Measure the interval between the AC plug-in and stable output.

**Table 5. Test Result**

Input Voltage	Turn On Time (s)	Specification
90 V / 60 Hz	1.56	<3 s
264 V / 50 Hz	0.465	

## 11. Hold-up Time

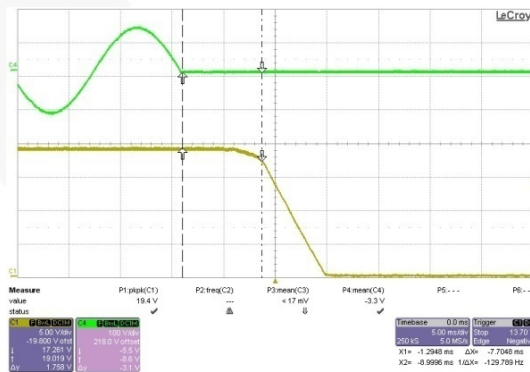
### 11.1. Test Condition

Set the output at maximum load. Measure the time interval between the AC power-off and output voltage falling to the lower limit of rated value. The AC waveform should be off at zero degrees.

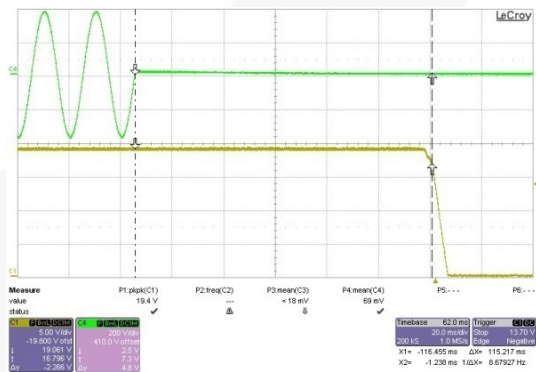
**Table 6. Test Result**

Input Voltage	Hold-up Time (ms)
90 V / 60 Hz	7.7
115 V / 60 Hz	15.1
230 V / 50 Hz	83.9
264 V / 50 Hz	115.2

### 11.2. Measured Waveform



**Figure 9. 90 V / 60 Hz at Maximum Load, Ch1: V<sub>AC</sub>, Ch4: V<sub>O</sub>**



**Figure 10. 264 V / 50 Hz at Maximum Load, Ch1: V<sub>AC</sub>, Ch4: V<sub>O</sub>**

## 12. DC Output Rising Time

### 12.1. Test Condition

Set the output at maximum loading and no loading. Measure the time interval between 10% to 90% of the output during startup.

**Table 7. Test Result**

Input Voltage	Maximum Load (ms)	No Load (ms)	Specification
90 V / 60 Hz	5.18	4.25	< 20 ms
264 V / 50 Hz	4.28	3.49	

### 12.2. Measured Waveform

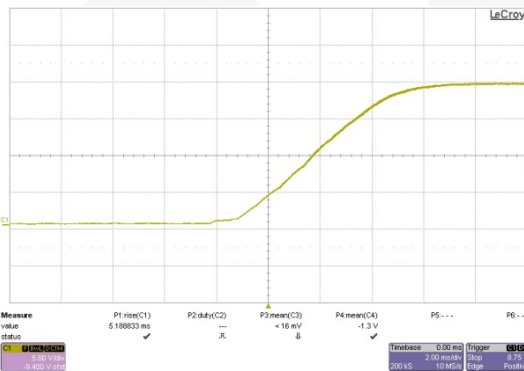


Figure 11. 90 V / 60 Hz at Maximum Load, Ch1: V<sub>O</sub>

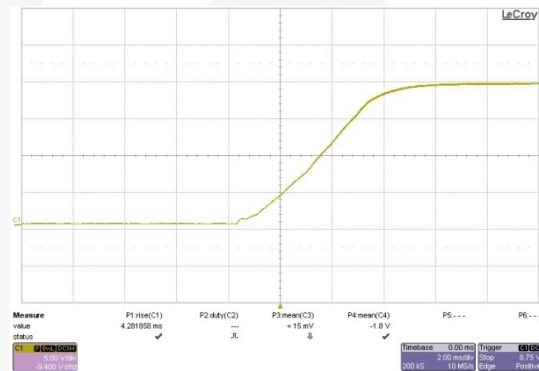


Figure 12. 264 V / 50 Hz at Maximum Load, Ch1: V<sub>O</sub>

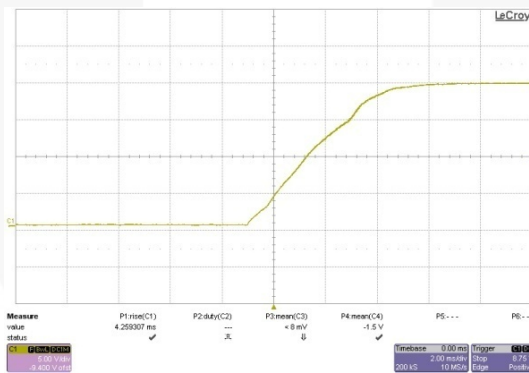


Figure 13. 90 V / 60 Hz at No Load, Ch1: V<sub>O</sub>

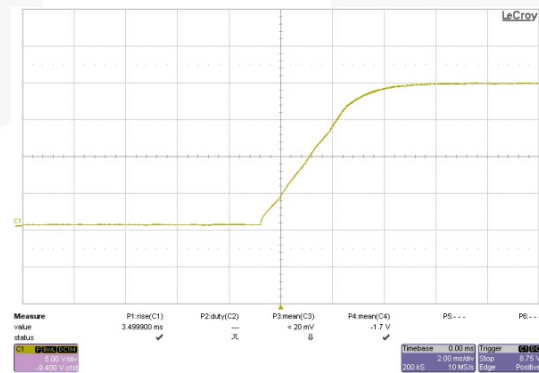


Figure 14. 264 V / 50 Hz at No Load, Ch4: V<sub>O</sub>

## 13. Line & Load Regulation

### 13.1. Test Condition

Measure line and load regulation according to Table 8.

**Table 8. Test Result**

Input Voltage	Output Voltage at Max. Load (V)	Output Voltage at Min. Load(V)	Load Regulation (%)	Specification
90 V / 60 Hz	19.106	19.28	0.90	5%
115 V / 60 Hz	19.100	19.28	0.90	
132 V / 60 Hz	19.090	19.27	0.90	
180 V / 50 Hz	19.090	19.27	0.90	
230 V / 50 Hz	19.088	19.27	0.90	
264 V / 50 Hz	19.080	19.27	0.90	
Line Regulation	0.13%	0.05%		

## 14. Efficiency

### 14.1. Test Condition

Output at maximum load.

**Table 9. Test Result**

Input Voltage	Input Wattage (W)	Output Wattage (W)	Efficiency (%)	Specification
90 V / 60 Hz	45.32	39.98	88.20	
115 V / 60 Hz	44.69	39.96	89.40	
132 V / 60 Hz	44.50	39.91	89.60	
180 V / 50 Hz	44.31	39.91	90.06	
230 V / 50 Hz	44.26	39.91	90.10	
264 V / 50 Hz	44.56	39.92	89.58	

**Table 10. Test Result**

Input Voltage	Efficiency (%)					Specification
	25% Load	50% Load	75% Load	100% Load	Avg.	
115 V / 60 Hz	89.4	90.0	89.5	89.4	89.5	
230 V / 50 Hz	89.4	89.6	90.3	90.2	89.8	

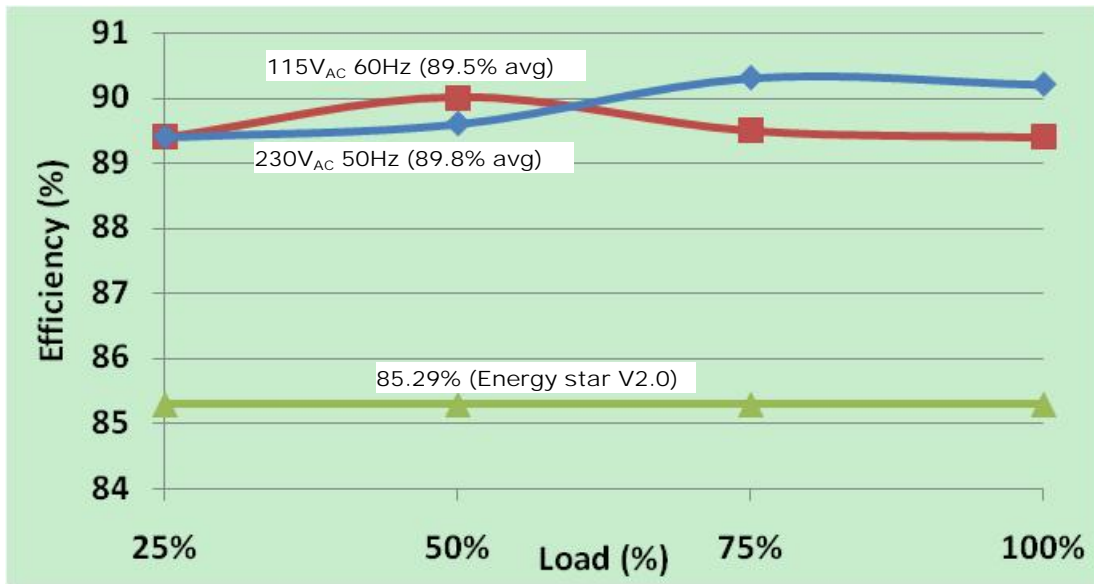


Figure 15. Efficiency at Various Loads



## 15. Output Ripple & Noise

### 15.1. Test Condition

Ripple and noise are measured by using a 20 MHz bandwidth-limited oscilloscope with a 10  $\mu$ F capacitor paralleled with a high-frequency 0.1  $\mu$ F capacitor across each output.

**Table 11. Test Result**

Input Voltage	Maximum Load (mV)	Minimum Load (mV)
90 V / 60 Hz	286	117
115 V / 60 Hz	264	125
230 V / 50 Hz	255	150
264 V / 50 Hz	248	160

### 15.2. Measured Waveform

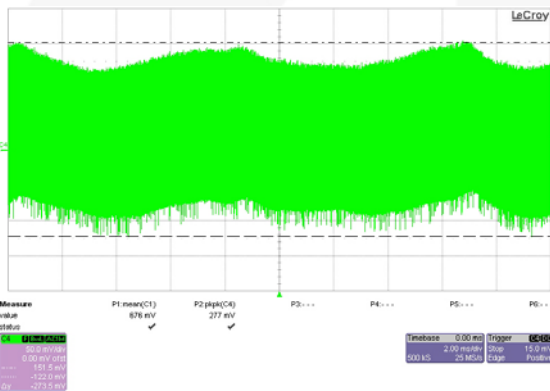


Figure 16. 90 V / 60 Hz at Maximum Load, Ch4: V<sub>O</sub>

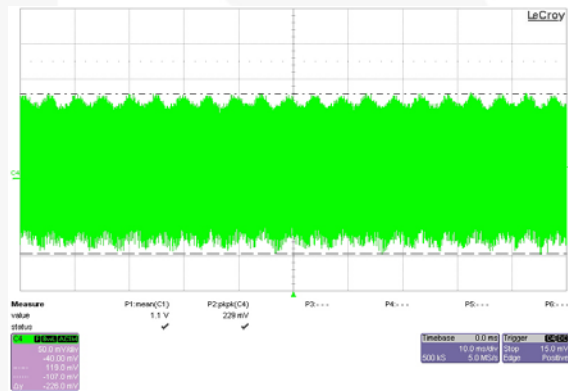


Figure 17. 264 V / 50 Hz at Maximum Load, Ch4: V<sub>O</sub>

## 16. Step Response

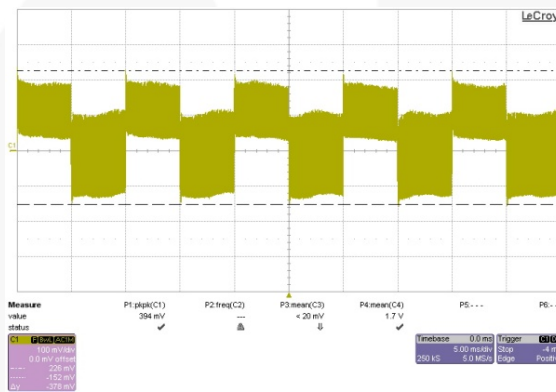
### 16.1. Test Condition

Dynamic loading (20%~80% of the full load, 5 ms duty cycle, 2.5 A/ $\mu$ s rise / fall time).

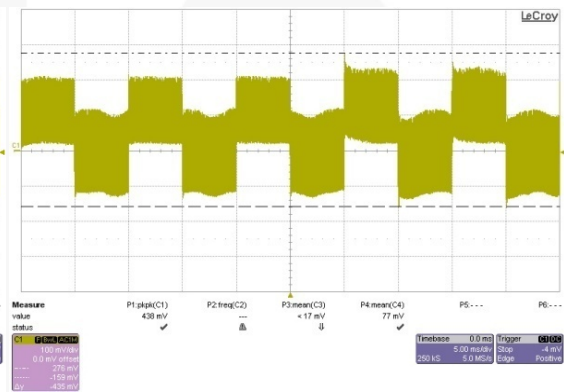
**Table 12. Test Result**

Input Voltage	Overshoot (mV)	Undershoot (mV)
115 V / 60 Hz	217	152
230 V / 50 Hz	276	159

### 16.2. Measured Waveform



**Figure 18. 115 V / 60 Hz at Maximum Load, Ch1: V<sub>O</sub>**



**Figure 19. 264 V / 50 Hz at Maximum Load, Ch1: V<sub>O</sub>**

## 17. Over-Current Protection (OCP)

### 17.1. Test Condition

Increase output loading gradually. Measure the output maximum current.

**Table 13. Test Result**

Input Voltage	Maximum Load (ms)
90 V / 60 Hz	2.94
115 V / 60 Hz	3.27
230 V / 50 Hz	3.39
264 V / 50 Hz	3.37

## 18. Short-Circuit Protection

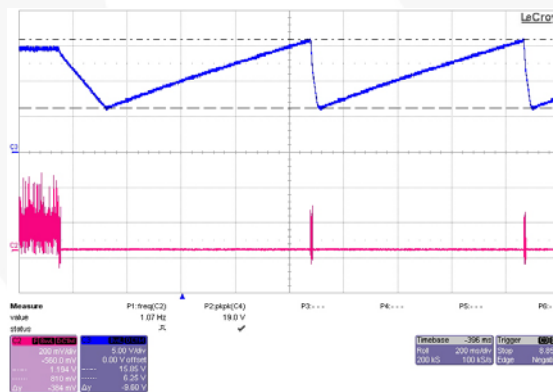
### 18.1. Test Condition

Short the output of the power supply. The power supply should enter “Hiccup” Mode protection with less than 2 W input voltage.

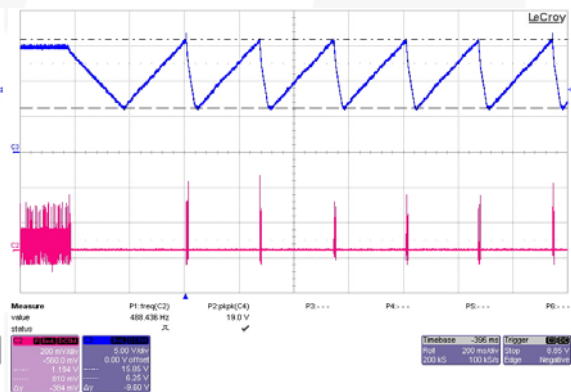
**Table 14. Test Result**

Input Voltage	Input Wattage at Maximum Loading (W)	Input Wattage at Minimum Loading (W)	Specification
90 V / 60 Hz	0.15	0.15	<2 W
264 V / 50 Hz	0.35	0.34	

### 18.2. Measured Waveform (Output-Short Condition)



**Figure 20. 90 V / 60 Hz at Maximum Load, Ch2: V<sub>CS</sub>, Ch3: V<sub>DD</sub>**



**Figure 21. 264 V / 50 Hz at Maximum Load, Ch2: V<sub>CS</sub>, Ch3: V<sub>DD</sub>**

## 19. Brownout Test

### 19.1. Test Condition

Set the output at maximum loading. Decrease the input voltage with 5 V<sub>AC</sub> step. Record the input wattage and output voltage. After the output is off, increase the AC voltage gradually and record the recovery voltage.

**Table 15. Test Result**

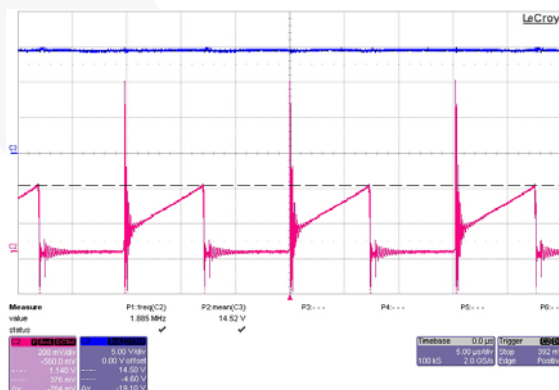
Input Voltage	Input Wattage (W)	Output Voltage (V)
90 V / 60 Hz	45.75	19.10
85 V / 60 Hz	45.87	19.10
80 V / 60 Hz	46.26	19.10
75 V / 60 Hz	46.62	19.10
70 V / 60 Hz	0	0
65 V / 60 Hz	0	0
60 V / 60 Hz	0	0
55 V / 60 Hz	0	0

## 20. V<sub>DD</sub> Voltage Level

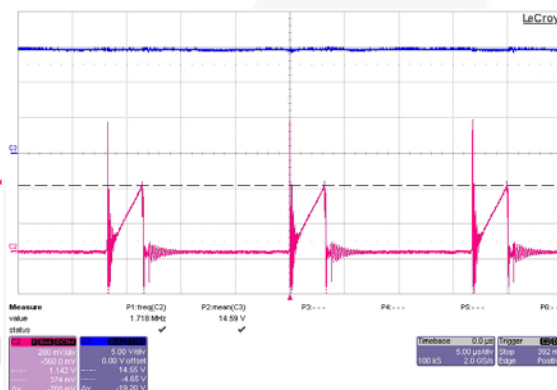
**Table 16. Test Result**

	Minimum Load (V)	Maximum Load (V)	Near OPP (V)	Output S.C. (Maximum Value) (V)
90 V / 60 Hz	12.45	14.80	16.40	15.95
264V / 50 Hz	12.60	14.00	15.00	15.95

### 20.1. Measured Waveform



**Figure 22. 90 V / 60 Hz at Maximum Load, Ch1: V<sub>DD</sub>, Ch2: V<sub>CS</sub>**



**Figure 23. 264 V / 50 Hz at Maximum Load, Ch1: V<sub>DD</sub>, Ch2: V<sub>CS</sub>**

## 21. Voltage Stress on MOSFET & Rectifiers

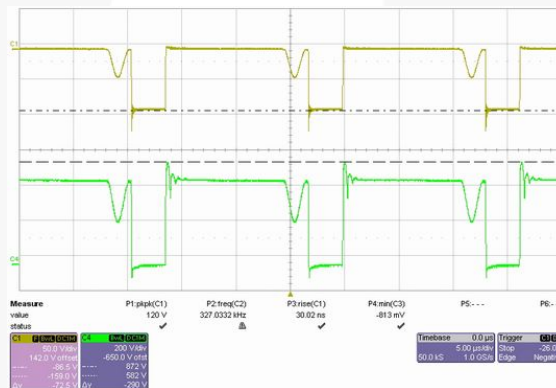
### 21.1. Test Condition

Measure the voltage stress on the MOSFET and secondary rectifiers under below specified conditions.

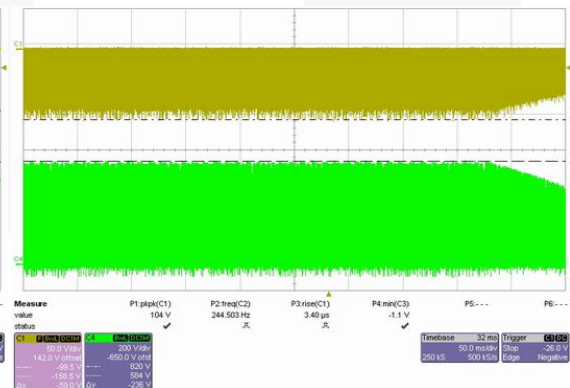
**Table 17. Test Result**

	Stress On MOSFET	Rating	Stress On Output Rectifier	Rating
90 V / 60 Hz, Maximum Load	322	600 V	55	100 V
90 V / 60 Hz, Maximum Load, Startup	361		49	
90 V / 60 Hz, Maximum Load, Output Short	294		28	
264 V / 50 Hz, Maximum Load	582		86	
264 V / 50 Hz, Maximum Load, Startup	534		99	
264 V / 50 Hz, Maximum Load, Output Short	502		93	
264 V / 50 Hz, Maximum Load Turns Off	322		55	

### 21.2. Measured Waveform

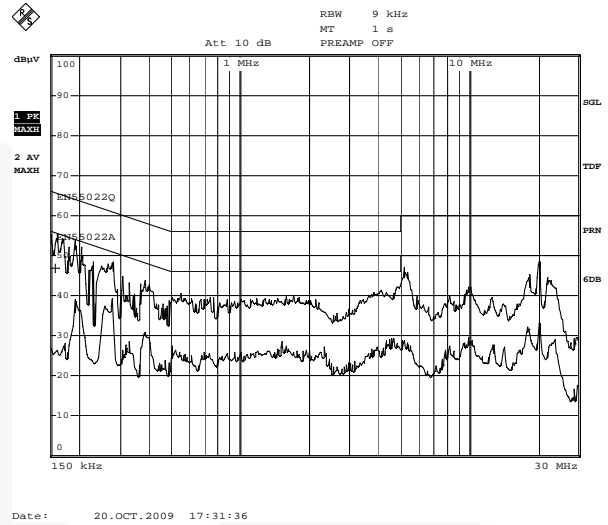
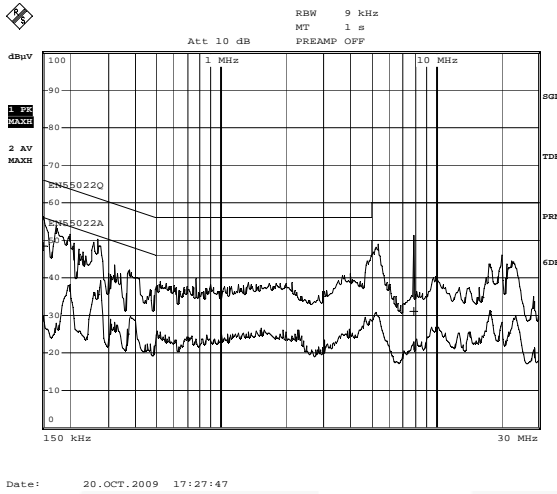


**Figure 24.** 264 V / 50 Hz at Maximum Load, Ch1:  $V_{DS}$ (MOSFET), Ch4:  $V_{AK}$ (RECTIFIER)

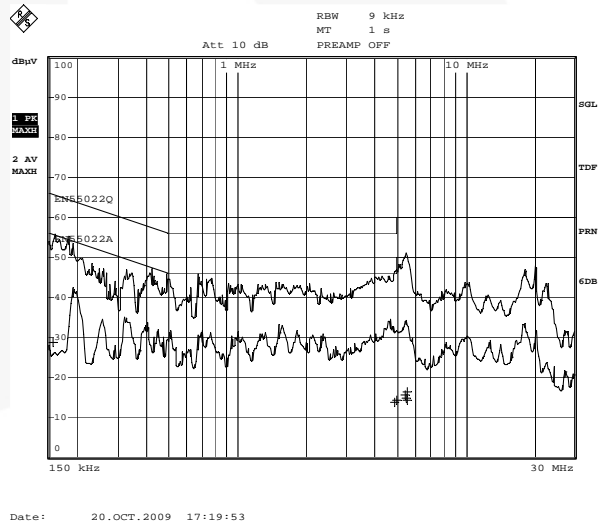
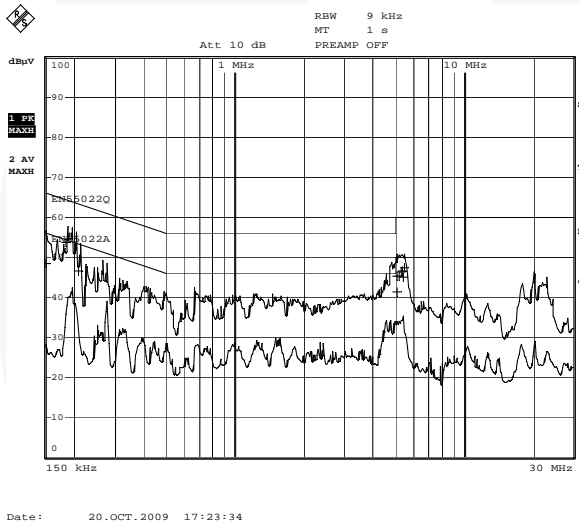


**Figure 25.** 264 V / 50 Hz at Maximum Load (Turns Off), Ch1:  $V_{DS}$ (MOSFET), Ch4:  $V_{AK}$ (RECTIFIER)

### 21.3. Electromagnetic Interference (EMI) Test



**Figure 26. Conduction-Line & Neutral at 115V<sub>AC</sub>**



**Figure 27. Conduction-Line & Neutral At 115V<sub>AC</sub>**

## 22. Surge Test

Mode	Polarity	Phase	Voltage	Condition
L-PE	±	0°	4.4 kV	Pass
	±	90°		Pass
	±	180°		Pass
	±	270°		Pass
N-PE	±	0°	4.4 kV	Pass
	±	90°		Pass
	±	180°		Pass
	±	270°		Pass
L-N	±	0°	2.0 kV	Pass
	±	90°		Pass
	±	180°		Pass
	±	270°		Pass

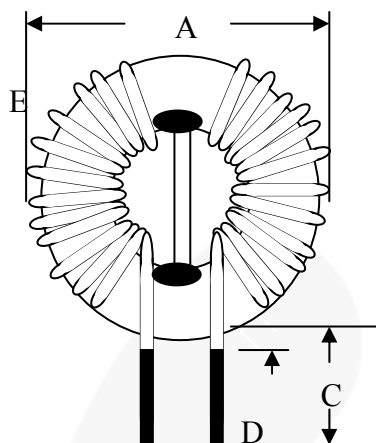
## 23. ESD Test

Air Discharge (16.5 kV)		Contact Discharge (8.8 kV)	
Pass	Pass	Pass	Pass

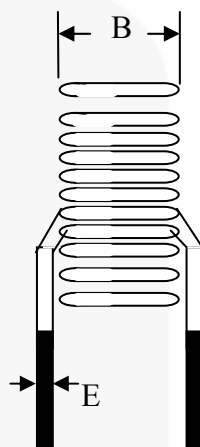
**SPECIFICATION APPROVAL**

Customer	SYSTEM GENERAL CORP.			P/N:	TRN-0279
DATE	08/02/2010	Version	A	Page	1/1

1. DIMENSION :



UNIT : mm



A	22 max
B	12 max
C	18 ± 1
D	15 max
E	φ0.6 ±0.1

2. ELECTRICAL SPECIFICATION : at 1 kHz, 1 V

2.1 INDUCTANCE : L1=L2 : 22 mH min

2.2 DC RESISTANCE : L1=L2 : 0.78 Ohm max

2.3 TURN & WIRE : L1=L2 : φ0.6 x 40TS

MATERIALS LIST :

COMPONENT	MATERIAL	MANUFACTURE	UL FILE NO.
1.CORE	T18.5x9.8x7	core T18.5x9.8x8 JFE FERRITE Corp.	
2.WIRE	THFN-216	Ta Ya electric wire CO.,LTD	E197768
	UEWN/U	PACIFIC wire & cable CO.,LTD	E201757
	UEWE	Tai-l electric wire & cable CO.,LTD	E85640
	UWY	Jang Shing wire CO.,LTD	E174837
3.SOLDER	96.5% Sn,3% Ag,0.5% Cu,	Xin Yuan CO.,LTD	

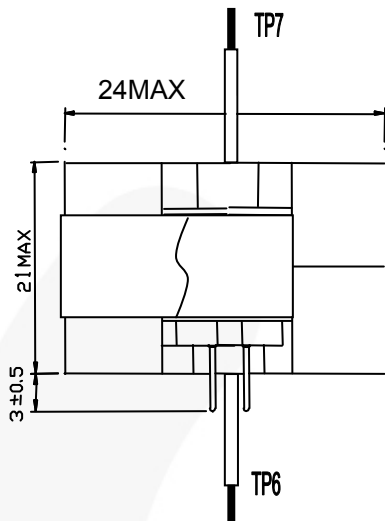
UNIT	m/m	DRAWN	CHECK	TITLE	
TEL	(02)29450588	Ci wun Chen	Guo long Huang	IDENT N O.	TRN-0279
FAX	(02)29447647	SEN HUEI INDUSTRIAL CO.,LTD.		D W G N O.	
No.26-1, Lane 128, Sec. 2, Singnan Rd., Jhonghe City, Taipei County 235, Taiwan (R.O.C.)					



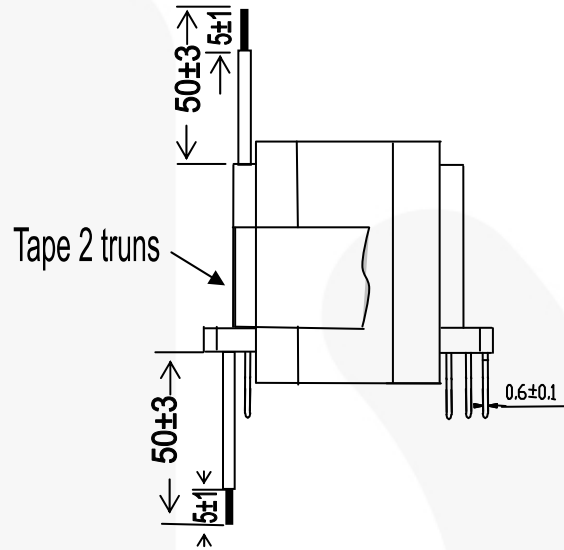
**SPECIFICATION APPROVAL**

Customer	SYSTEM GENERAL CORP.			P/N:	TRN-0280
DATE	08/12/2010	Version	A	Page	1/4

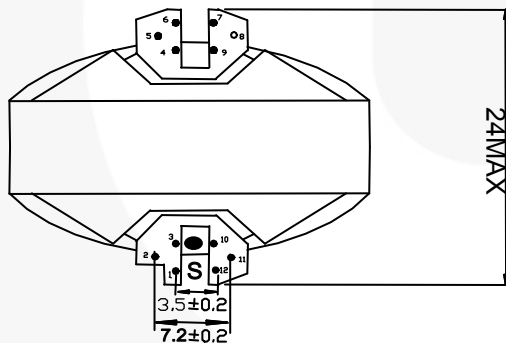
1.DIMENSION : Unit : mm



ELEVATION VIEW



SIDE VIEW



BOTTOM VIEW

**TRN-0280**

Past label on the top of transformer,  
and the wording peak faces pin 1 & pin 12

NOTE:

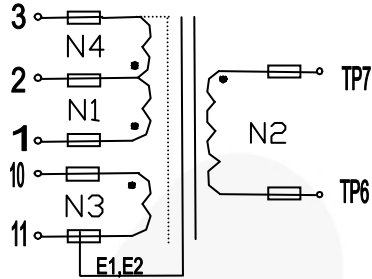
- 1) Cut off pin 2,4,5,6,7,8,9,12.
- 2) Core package of two turns tape.

UNIT	m/m	DRAWN	CHECK	TITLE	TRANS
TEL	(02)29450588	Ci wun Chen	Guo long Huang	IDENT N O.	TRN-0280
FAX	(02)29447647	SEN HUEI INDUSTRIAL CO.,LTD.		D W G N O.	I0802
No.26-1, Lane 128, Sec. 2, Singnan Rd., Jhonghe City, Taipei County 235, Taiwan (R.O.C.)					

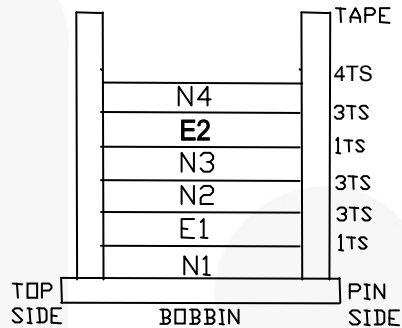
**SPECIFICATION APPROVAL**

<b>Customer</b>	<b>SYSTEM GENERAL CORP.</b>			<b>P/N:</b>	<b>TRN-0280</b>
<b>DATE</b>	<b>08/12/2010</b>	<b>Version</b>	<b>A</b>	<b>Page</b>	<b>2/4</b>

**2.SCHEMATIC :**  
**PRI**



**2.1SCHEMATIC :**  
**SEC**



Note: The shielding winds Copper Foil 7.5mm, and connects the pin11.

**2.3 WINDING :**

SET	WINDING	MATERIAL	START-FINISH	TURNS	TAPE	REMARK
1	N1	2UEW-φ0.25×1P	1-2	33 <sup>TS</sup>	1 <sup>TS</sup>	
2	E1	2UEW-φ0.2×1P	11	1.2 <sup>TS</sup>	3 <sup>TS</sup>	Add 7.5 mm tape of copper foil
3	N2	TLW-φ0.5×2P	TP6-TP7	12 <sup>TS</sup>	3 <sup>TS</sup>	Add Tube of Teflon
4	N3	2UEW-φ0.25×1P	10-11	9 <sup>TS</sup>	1 <sup>TS</sup>	
5	E2	2UEW-φ0.2×1P	11	1.2 <sup>TS</sup>	3 <sup>TS</sup>	Add 7.5 mm tape of copper foil
6	N4	2UEW-φ0.25×1P	2-3	33 <sup>TS</sup>	4 <sup>TS</sup>	

UNIT	m/m	DRAWN	CHECK	TITLE	TRANS
TEL	(02)29450588	Ci wun Chen	Guo long Huang	IDENT N O.	TRN-0280
FAX	(02)29447647	SEN HUEI INDUSTRIAL CO.,LTD.		D W G N O.	I0802
No.26-1, Lane 128, Sec. 2, Singnan Rd., Jhonghe City, Taipei County 235, Taiwan (R.O.C.)					

**SPECIFICATION APPROVAL**

<b>Customer</b>	<b>SYSTEM GENERAL CORP.</b>			<b>P/N:</b>	<b>TRN-0280</b>
<b>DATE</b>	<b>08/12/2010</b>	<b>Version</b>	<b>A</b>	<b>Page</b>	<b>3/4</b>

**3. ELECTRICAL SPECIFICATION :**

3.1 Inductance test : at 1 KHz ,1 V

$$L_{3-1} = 920 \mu\text{H} \pm 5\%$$

3.2 Leakage inductance : at 1 KHz ,1 V

P(4-6) : 15  $\mu\text{H}$  Max (shorted A,B)

3.3 DC Resistance test at 25°C

P(4-6) : 23 m $\Omega$  Max

3.4 Hi-pot test :

AC 3.0 KV /60 Hz/0.5 mA hi-pot for one minute between primary to sec.

AC 1.5 KV /60 Hz/0.5 mA hi-pot for one minute between primary to core.

AC 1.5 KV /60 Hz/0.5 mA hi-pot for one minute between sec to core.

3.5 Insulation test :

The insulation resistance is between primary to sec and windings to core measured by DC 500 V, must Be over 100 M $\Omega$ .

3.6 Terminal strength :

1.0 Kg on terminals for 30 seconds, test the breakdown.

<b>UNIT</b>	<b>m/m</b>	<b>DRAWN</b>	<b>CHECK</b>	<b>TITLE</b>	<b>TRANS</b>
<b>TEL</b>	(02)29450588	Ci wun Chen	Guo long Huang	<b>IDENT N O.</b>	TRN-0280
<b>FAX</b>	(02)29447647	<b>SEN HUEI INDUSTRIAL CO.,LTD.</b>		<b>D W G N O.</b>	<b>I0802</b>
No.26-1, Lane 128, Sec. 2, Singnan Rd., Jhonghe City, Taipei County 235, Taiwan (R.O.C.)					

### SPECIFICATION APPROVAL

<b>Customer</b>	<b>SYSTEM GENERAL CORP.</b>			<b>P/N:</b>	<b>TRN-0280</b>
<b>DATE</b>	<b>08/12/2010</b>	<b>Version</b>	<b>A</b>	<b>Page</b>	<b>4/4</b>

#### MATERIALS LIST

COMPONENT	MATERIAL	MANUFACTURE	FILE NO.
1. Bobbin	Phenolic 94v-0,T375J,150°C	RM-8 Chang Chun plastics co. ltd.	E59481(S)
2. Core	FERRITE 3C90 R2K (GAP)	Ferrite core RM-8 YANG GUANG DA CO.,LTD	
3. Wire	UEY 130°C	HOI LUEN ELECTRICAL MFR CO.,LTD	E164409
	TEX-E 130°C	SHEN ZHEN CHANGYUAN ELECTRONIC MATERIAL CO.,LTD	E249037
4. Varnish	48562/C 155°C	HANG CHEUNG PETROCHEMICAL LTD	E200154
5. Tape	MYLAR TAPE (PZ-YELLOW)	JINGJIANG YA HUA PRESSURE SENSITIVE GLUE CO.,LTD	E165111(N)
6. Tube	TEFOLN 200°C 150V	SHEN ZHEN WOER HEAT SHRINKABLE MATERIAL CO.,LTD	E203950
7. Terminals	Tin coated- Copper wire	Will fore special wire corp	
8. Shield	Copper foil	BO TONG CO.,LTD (copper foil : T0.025mm×7mm +TAPE)	
9. SOLDER	96.5% Su 3% Ag 0.5% Cu	Xin Yuan CO.,LTD	

UNIT	m/m	DRAWN	CHECK	TITLE	TRANS
TEL	(02)29450588	Ci wun Chen	Guo long Huang	IDENT N O.	TRN-0280
FAX	(02)29447647	SEN HUEI INDUSTRIAL CO.,LTD.		D W G N O.	I0802
No.26-1, Lane 128, Sec. 2, Singnan Rd., Jhonghe City, Taipei County 235, Taiwan (R.O.C.)					

## 24. Revision History

Rev.	Date	Description
1.0.0	September 2012	Initial Release

---

### WARNING AND DISCLAIMER

Replace components on the Evaluation Board only with those parts shown on the parts list (or Bill of Materials) in the Users' Guide. Contact an authorized Fairchild representative with any questions.

This board is intended to be used by certified professionals, in a lab environment, following proper safety procedures. Use at your own risk. The Evaluation board (or kit) is for demonstration purposes only and neither the Board nor this User's Guide constitute a sales contract or create any kind of warranty, whether express or implied, as to the applications or products involved. Fairchild warrants that its products meet Fairchild's published specifications, but does not guarantee that its products work in any specific application. Fairchild reserves the right to make changes without notice to any products described herein to improve reliability, function, or design. Either the applicable sales contract signed by Fairchild and Buyer or, if no contract exists, Fairchild's standard Terms and Conditions on the back of Fairchild invoices, govern the terms of sale of the products described herein.

#### DISCLAIMER

FAIRCHILD SEMICONDUCTOR RESERVES THE RIGHT TO MAKE CHANGES WITHOUT FURTHER NOTICE TO ANY PRODUCTS HEREIN TO IMPROVE RELIABILITY, FUNCTION, OR DESIGN. FAIRCHILD DOES NOT ASSUME ANY LIABILITY ARISING OUT OF THE APPLICATION OR USE OF ANY PRODUCT OR CIRCUIT DESCRIBED HEREIN; NEITHER DOES IT CONVEY ANY LICENSE UNDER ITS PATENT RIGHTS, NOR THE RIGHTS OF OTHERS.

#### LIFE SUPPORT POLICY

FAIRCHILD'S PRODUCTS ARE NOT AUTHORIZED FOR USE AS CRITICAL COMPONENTS IN LIFE SUPPORT DEVICES OR SYSTEMS WITHOUT THE EXPRESS WRITTEN APPROVAL OF THE PRESIDENT OF FAIRCHILD SEMICONDUCTOR CORPORATION.

As used herein:

1. Life support devices or systems are devices or systems which, (a) are intended for surgical implant into the body, or (b) support or sustain life, or (c) whose failure to perform when properly used in accordance with instructions for use provided in the labeling, can be reasonably expected to result in significant injury to the user.
2. A critical component is any component of a life support device or system whose failure to perform can be reasonably expected to cause the failure of the life support device or system, or to affect its safety or effectiveness.

---

### ANTI-COUNTERFEITING POLICY

Fairchild Semiconductor Corporation's Anti-Counterfeiting Policy. Fairchild's Anti-Counterfeiting Policy is also stated on our external website, [www.fairchildsemi.com](http://www.fairchildsemi.com), under Sales Support.

Counterfeiting of semiconductor parts is a growing problem in the industry. All manufacturers of semiconductor products are experiencing counterfeiting of their parts. Customers who inadvertently purchase counterfeit parts experience many problems such as loss of brand reputation, substandard performance, failed applications, and increased cost of production and manufacturing delays. Fairchild is taking strong measures to protect ourselves and our customers from the proliferation of counterfeit parts. Fairchild strongly encourages customers to purchase Fairchild parts either directly from Fairchild or from Authorized Fairchild Distributors who are listed by country on our web page cited above. Products customers buy either from Fairchild directly or from Authorized Fairchild Distributors are genuine parts, have full traceability, meet Fairchild's quality standards for handling and storage and provide access to Fairchild's full range of up-to-date technical and product information. Fairchild and our Authorized Distributors will stand behind all warranties and will appropriately address any warranty issues that may arise. Fairchild will not provide any warranty coverage or other assistance for parts bought from Unauthorized Sources. Fairchild is committed to combat this global problem and encourage our customers to do their part in stopping this practice by buying direct or from authorized distributors.

---

### EXPORT COMPLIANCE STATEMENT

These commodities, technology, or software were exported from the United States in accordance with the Export Administration Regulations for the ultimate destination listed on the commercial invoice. Diversion contrary to U.S. law is prohibited.

U.S. origin products and products made with U.S. origin technology are subject to U.S. Re-export laws. In the event of re-export, the user will be responsible to ensure the appropriate U.S. export regulations are followed.

ON Semiconductor and  are trademarks of Semiconductor Components Industries, LLC dba ON Semiconductor or its subsidiaries in the United States and/or other countries. ON Semiconductor owns the rights to a number of patents, trademarks, copyrights, trade secrets, and other intellectual property. A listing of ON Semiconductor's product/patent coverage may be accessed at [www.onsemi.com/site/pdf/Patent-Marking.pdf](http://www.onsemi.com/site/pdf/Patent-Marking.pdf). ON Semiconductor reserves the right to make changes without further notice to any products herein. ON Semiconductor makes no warranty, representation or guarantee regarding the suitability of its products for any particular purpose, nor does ON Semiconductor assume any liability arising out of the application or use of any product or circuit, and specifically disclaims any and all liability, including without limitation special, consequential or incidental damages. Buyer is responsible for its products and applications using ON Semiconductor products, including compliance with all laws, regulations and safety requirements or standards, regardless of any support or applications information provided by ON Semiconductor. "Typical" parameters which may be provided in ON Semiconductor data sheets and/or specifications can and do vary in different applications and actual performance may vary over time. All operating parameters, including "Typicals" must be validated for each customer application by customer's technical experts. ON Semiconductor does not convey any license under its patent rights nor the rights of others. ON Semiconductor products are not designed, intended, or authorized for use as a critical component in life support systems or any FDA Class 3 medical devices or medical devices with a same or similar classification in a foreign jurisdiction or any devices intended for implantation in the human body. Should Buyer purchase or use ON Semiconductor products for any such unintended or unauthorized application, Buyer shall indemnify and hold ON Semiconductor and its officers, employees, subsidiaries, affiliates, and distributors harmless against all claims, costs, damages, and expenses, and reasonable attorney fees arising out of, directly or indirectly, any claim of personal injury or death associated with such unintended or unauthorized use, even if such claim alleges that ON Semiconductor was negligent regarding the design or manufacture of the part. ON Semiconductor is an Equal Opportunity/Affirmative Action Employer. This literature is subject to all applicable copyright laws and is not for resale in any manner.

## PUBLICATION ORDERING INFORMATION

### LITERATURE FULFILLMENT:

Literature Distribution Center for ON Semiconductor  
19521 E. 32nd Pkwy, Aurora, Colorado 80011 USA  
**Phone:** 303-675-2175 or 800-344-3860 Toll Free USA/Canada  
**Fax:** 303-675-2176 or 800-344-3867 Toll Free USA/Canada  
**Email:** [orderlit@onsemi.com](mailto:orderlit@onsemi.com)

**N. American Technical Support:** 800-282-9855 Toll Free  
USA/Canada  
**Europe, Middle East and Africa Technical Support:**  
Phone: 421 33 790 2910  
**Japan Customer Focus Center**  
Phone: 81-3-5817-1050

**ON Semiconductor Website:** [www.onsemi.com](http://www.onsemi.com)  
**Order Literature:** <http://www.onsemi.com/orderlit>  
For additional information, please contact your local  
Sales Representative