

# DTCXO Temperature Compensated Real Time Clock Module with I<sup>2</sup>C Bus

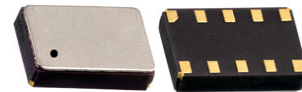

3.7 x 2.5 x 0.9 mm

AB-RTCMC-32.768kHz-EOZ9-S3



RoHS/RoHS II compliant

Moisture Sensitivity Level: MSL=1

## FEATURES:

- With state-of-the-art RTC Technology by Micro Crystal AG
- RTC module with built-in “Tuning Fork” crystal oscillating at 32.768 kHz
- Factory calibrated, all built-in Temperature Compensation circuitry Time accuracy Option A & B. See Part Identification on page 7 for details
- Ultra low power consumption: 800nA typ @ VDD = 3.0V / Tamb = 25°C
- Wide clock operating voltage: 1.3 – 5.5V
- Wide interface operating voltage: 1.4 – 5.5V
- Extended operating temperature range: -40°C to +125°C
- I2C serial interface with fast mode SCL clock frequency of 400kHz
- Provides year, month, day, weekday, hours, minutes and seconds
- Highly versatile alarm and timer functions
- Integrated Low-Voltage Detector, Power-On Reset and Self-Recovery System
- Main Power Supply to Backup Battery switchover circuitry with Trickle Charger
- Programmable CLKOUT pins for peripheral devices (32.768 kHz / 1024 Hz / 32 Hz / 1 Hz)
- Small and compact package size: 3.7 x 2.5 x 0.9 mm. RoHS-compliant and 100% leadfree

## APPLICATIONS:

- Wide range in communication & measuring equipment
- Commercial & Industrial applications
- Automotive electronics applications
- Wireless communications
- PDA and Palm Pilots
- Credit Cards with Security Technology

## STANDARD SPECIFICATIONS:

### Absolute Maximum Ratings

Parameters	Min.	Typ.	Max.	Units	Notes
Supply Voltage (V <sub>DD</sub> )	GND-0.3		+6.0	V	>GND / <V <sub>DD</sub>
Supply Current (I <sub>DD</sub> ; I <sub>SS</sub> )	-50		+50	mA	V <sub>DD</sub> Pin
Input Voltage (V <sub>I</sub> )	GND-0.3		V <sub>DD</sub> +0.3	V	Input Pin
Output Voltage (V <sub>O</sub> )	GND-0.5		V <sub>DD</sub> +0.5	V	$\overline{\text{INT}}/\text{CLKOUT}$
DC Input Current (I <sub>I</sub> )	-10		+10	mA	
DC Output Current (I <sub>O</sub> )	-10		+10	mA	
Total Power Dissipation (P <sub>TOT</sub> )			300	mW	
Operating Temperature Range (T <sub>OPR</sub> )	-40		+125	°C	
Storage Temperature (T <sub>STO</sub> )	-55		+125	°C	Stored as bare product

### Frequency and Time Characteristics

V<sub>DD</sub>=3.0V; V<sub>SS</sub>=0V; T<sub>AMB</sub>=+25°C; f<sub>OSC</sub>=32.768kHz

Parameters	Min.	Typ.	Max.	Units	Notes
<b>32.768kHz Oscillator Characteristics</b>					
Frequency Accuracy (ΔF/F)		±10	±20	ppm	F <sub>CLKOUT</sub> =32.768kHz; T <sub>AMB</sub> =+25°C; V <sub>DD</sub> =3.0V
Frequency vs Voltage (ΔF/V)		±0.5	±1.0	ppm/V	T <sub>AMB</sub> =+25°C; V <sub>DD</sub> =1.4~5.5V
Frequency vs Temperature (ΔF/T <sub>OPR</sub> )	-0.035ppm/°C <sup>2</sup> (T <sub>OPR</sub> -T <sub>O</sub> ) <sup>2</sup> ±10%			ppm	T <sub>OPR</sub> =-40~+125°C; V <sub>DD</sub> =3.0V
Turnover Temperature (T <sub>O</sub> )	+20	+25	+30	°C	
Aging (first year)	-3		+3	ppm	T <sub>AMB</sub> =+25°C
Start-up Time Voltage (V <sub>START</sub> )					
Start-up Time (T <sub>START</sub> )		0.5	3	s	T <sub>AMB</sub> =-40 ~ +85°C
		1	3		T <sub>AMB</sub> =-40 ~ +125°C
CLKOUT duty cycle	40	50	60	%	F <sub>CLKOUT</sub> =32.768kHz; T <sub>AMB</sub> =+25°C

# DTCXO Temperature Compensated Real Time Clock Module with I<sup>2</sup>C Bus

AB-RTCMC-32.768kHz-EOZ9-S3



RoHS/RoHS II compliant

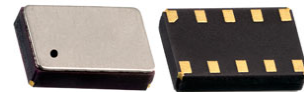

3.7 x 2.5 x 0.9 mm

(Continued)

Parameters		Min.	Typ.	Max.	Units	Notes
<b>Time accuracy, DTCXO Digitally Temperature Compensated</b>						
Time Accuracy Option: A ( $\Delta t/t$ )	$T_{AMB}=+25^{\circ}\text{C}$		$\pm 1$	$\pm 3$	ppm	
	$T_{AMB}=0 \sim +50^{\circ}\text{C}$		$\pm 2$	$\pm 4$		
	$T_{AMB}=-10 \sim +65^{\circ}\text{C}$		$\pm 3$	$\pm 5$		
	$T_{AMB}=-40 \sim +85^{\circ}\text{C}$		$\pm 4$	$\pm 6$		
	$T_{AMB}=-40 \sim +125^{\circ}\text{C}$		$\pm 5$	$\pm 8$		
Time Accuracy Option: B ( $\Delta t/t$ )	$T_{AMB}=+25^{\circ}\text{C}$		$\pm 1$	$\pm 3$	ppm	
	$T_{AMB}=0 \sim +50^{\circ}\text{C}$		$\pm 3$	$\pm 5$		
	$T_{AMB}=-10 \sim +65^{\circ}\text{C}$		$\pm 5$	$\pm 10$		
	$T_{AMB}=-40 \sim +85^{\circ}\text{C}$		$\pm 10$	$\pm 25$		
	$T_{AMB}=-40 \sim +125^{\circ}\text{C}$		$\pm 15$	$\pm 30$		

## Static Characteristics

$V_{DD}=1.4\sim 5.5\text{V}$ ;  $V_{SS}=0\text{V}$ ;  $T_{AMB}=-40^{\circ}\text{C} \sim +125^{\circ}\text{C}$ ;  $f_{OSC}=32.768\text{kHz}$

Parameters		Min.	Typ.	Max.	Units	Notes
<b>Supplies</b>						
Supply Voltage ( $V_{DD}$ )		1.4		5.5	V	Time-keeping mode I <sup>2</sup> C bus reduced speed
		2.1		5.5		I <sup>2</sup> C bus full speed
Minimum Supply Voltage Detection ( $V_{LOW1}$ )		1.8		2.1	V	$T_{AMB}=-40 \sim +125^{\circ}\text{C}$
Minimum Supply Voltage Detection ( $V_{LOW2}$ )		1.0		1.4	V	$T_{AMB}=-40 \sim +125^{\circ}\text{C}$
Main Supply to Backup Supply Switchover Hysteresis ( $V_{HYST}$ )			20		mV	$V_{DD}$ to $V_{BACK} = 3.0\text{V}$
Supply Current $I_{DD}$ ( $V_{BACK}=0\text{V}$ ) or $I_{BACK}$ ( $V_{DD}=0\text{V}$ )	$V_{DD}=1.4\text{V}$ $T_{AMB}=-40^{\circ}\text{C} \sim +85^{\circ}\text{C}$		0.6	1.5	$\mu\text{A}$	SPI bus inactive CLKOUT disabled $V_{BACK}=0\text{V}$ Or $V_{DD}=0\text{V}$
	$V_{DD}=1.4\text{V}$ $T_{AMB}=-40^{\circ}\text{C} \sim +125^{\circ}\text{C}$			4.6		
	$V_{DD}=3.3\text{V}$ $T_{AMB}=-40^{\circ}\text{C} \sim +85^{\circ}\text{C}$		0.8	2.0		
	$V_{DD}=3.3\text{V}$ $T_{AMB}=-40^{\circ}\text{C} \sim +125^{\circ}\text{C}$			5.2		
	$V_{DD}=5.0\text{V}$ $T_{AMB}=-40^{\circ}\text{C} \sim +85^{\circ}\text{C}$		0.9	2.2		
	$V_{DD}=5.0\text{V}$ $T_{AMB}=-40^{\circ}\text{C} \sim +125^{\circ}\text{C}$			5.5		

# DTCXO Temperature Compensated Real Time Clock Module with I<sup>2</sup>C Bus

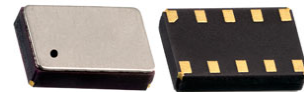

3.7 x 2.5 x 0.9 mm

AB-RTCMC-32.768kHz-EOZ9-S3



RoHS/RoHS II compliant

(Continued)

Parameters		Min.	Typ.	Max.	Units	Notes
Supply Current (I <sub>DD</sub> )	SCL= 200kHz V <sub>DD</sub> = 1.4V T <sub>AMB</sub> = -40°C ~ +85°C			14	μA	SPI bus active CLKOUT disabled
	SCL= 200kHz V <sub>DD</sub> = 1.4V T <sub>AMB</sub> = -40°C ~ +125°C			18		
	SCL= 1MHz V <sub>DD</sub> = 3.3V T <sub>AMB</sub> = -40°C ~ +85°C			50		
	SCL= 1MHz V <sub>DD</sub> = 3.3V T <sub>AMB</sub> = -40°C ~ +125°C			55		
	SCL= 1MHz V <sub>DD</sub> = 5.0V T <sub>AMB</sub> = -40°C ~ +85°C			65		
	SCL= 1MHz V <sub>DD</sub> = 5.0V T <sub>AMB</sub> = -40°C ~ +125°C			75		
Current Consumption (I <sub>DD32K</sub> )	V <sub>DD</sub> =5.0V		2.5	3.4	μA	SPI bus inactive CLKOUT =32.768kHz C <sub>LOAD</sub> =7.5pF
	V <sub>DD</sub> =3.3V		1.5	2.2		
	V <sub>DD</sub> =1.4V		1.1	1.6		
<b>Input</b>						
LOW Level Input Voltage (V <sub>IL</sub> )				20%* V <sub>DD</sub>	V	V <sub>DD</sub> = 1.4 ~ 5.5V <sub>DD</sub> Pins:SCL,SDI,CLKOE,CE
HIGH Level Input Voltage (V <sub>IH</sub> )		80%* V <sub>DD</sub>			V	
Input Leakage Current (I <sub>L</sub> )	T <sub>amb</sub> =-40 ~+85°C	-1		+1	μA	V <sub>SS</sub> >V <sub>I</sub> <V <sub>DD</sub>
	T <sub>amb</sub> =-40 ~+125°C	-1.5		+1.5		
Input Capacitance (C <sub>I</sub> )				7	pF	

# DTCXO Temperature Compensated Real Time Clock Module with I<sup>2</sup>C Bus

AB-RTCMC-32.768kHz-EOZ9-S3



RoHS/RoHS II compliant

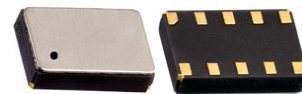

3.7 x 2.5 x 0.9 mm

(Continued)

Parameters		Min.	Typ.	Max.	Units	Notes
<b>Output</b>						
HIGH Level Output Voltage ( $V_{OH}$ )	$V_{DD} = 1.4V; I_{OH} = 0.1mA$	1.0			V	
	$V_{DD} = 3.3V; I_{OH} = 1.5mA$	2.7				
	$V_{DD} = 5.0V; I_{OH} = 2.0mA$	4.5				
LOW Level Output Voltage ( $V_{OL}$ )	$V_{DD} = 1.4V; I_{OL} = 0.4mA$			0.2	V	
	$V_{DD} = 3.3V; I_{OL} = 1.5mA$			0.25		
	$V_{DD} = 5.0V; I_{OL} = 5.0mA$			0.8		
HIGH Level Output Current ( $I_{OH}$ )	$V_{OH} = 4.5V / V_{DD} = 5V$			2.0	mA	
LOW Level Output Current ( $I_{OL}$ )	$V_{OL} = 0.8V / V_{DD} = 5V$			-5.0	mA	
Output Leakage Current ( $I_{LO}$ )	$V_O = V_{DD}$ or $V_{SS}$ $T_{AMB} = -40^{\circ}C \sim +85^{\circ}C$	-1	0	+1	$\mu A$	
	$V_O = V_{DD}$ or $V_{SS}$ $T_{AMB} = -40^{\circ}C \sim +125^{\circ}C$	-1.5	0	+1.5		
<b>Operating Temperature Range</b>						
Operating Temperature Range ( $T_{OPR}$ )		-40		+125	$^{\circ}C$	
<b>EEPROM Characteristics</b>						
Read Voltage ( $V_{Read}$ )	$T_{AMB} = -40^{\circ}C \sim +125^{\circ}C$	1.4			V	
Programming Voltage ( $V_{Prog}$ )	$T_{AMB} = -40^{\circ}C \sim +125^{\circ}C$	2.2			V	
EEPROM Programming Time ( $T_{Prog}$ )	$T_{AMB} = -40^{\circ}C \sim +125^{\circ}C$ 1 Byte EEPROM User			35	ms	
	$T_{AMB} = -40^{\circ}C \sim +125^{\circ}C$ 1 Byte EEPROM Control			100		
	$T_{AMB} = -40^{\circ}C \sim +125^{\circ}C$ 2-4 Byte EEPROM Control			135		
EEPROM Write/Erase Cycles ( $V_{HYST}$ )	$V_{DD}$ to $V_{BACK} = 3.0V$	5000			Cycles	

# DTCXO Temperature Compensated Real Time Clock Module with I<sup>2</sup>C Bus

AB-RTCMC-32.768kHz-EOZ9-S3



RoHS/RoHS II compliant

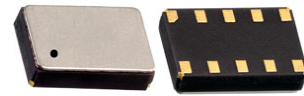

3.7 x 2.5 x 0.9 mm

(Continued)

Parameters		Min.	Typ.	Max.	Units	Notes
<b>Trickle Charger</b>						
Current Limiting Resistors	R80K		80		kΩ	V <sub>DD</sub> = 5.0V V <sub>BACK</sub> = 3.0V T <sub>AMB</sub> = 25°C
	R20k		20			
	R5k		5			
	R1.5k		1.5			
<b>Thermometer</b>						
Thermometer Precision (T <sub>E</sub> )	T <sub>AMB</sub> = -40°C ~ +85°C		±4		°C	
	T <sub>AMB</sub> = -40°C ~ +125°C		±6			

## I<sup>2</sup>C Interface Dynamic Characteristics

V<sub>SS</sub>=0V; T<sub>AMB</sub>=-40°C ~+125°C; All timing values are valid within the operating supply voltage range and references to V<sub>IL</sub> and V<sub>IH</sub> with an input voltage swing from V<sub>SS</sub> and V<sub>DD</sub>.

Parameters	Min.	Typ.	Max.	Units	Conditions
SCL Clock Frequency (f <sub>SCL</sub> )			100	kHz	V <sub>DD</sub> ≥ 1.4V
			300		V <sub>DD</sub> ≥ 1.8V
			400		V <sub>DD</sub> ≥ 3.0V
Start Condition Set-up Time (t <sub>SU; STA</sub> )	50			μs	V <sub>DD</sub> ≥ 1.4V
	30				V <sub>DD</sub> ≥ 1.8V
	20				V <sub>DD</sub> ≥ 3.0V
Start Condition Hold Time (t <sub>HD; STA</sub> )	0.2			μs	V <sub>DD</sub> ≥ 1.4V
					V <sub>DD</sub> ≥ 1.8V
					V <sub>DD</sub> ≥ 3.0V
Data Set-up Time (t <sub>SU; DAT</sub> )	100			ns	V <sub>DD</sub> ≥ 1.4V
	80				V <sub>DD</sub> ≥ 1.8V
	50				V <sub>DD</sub> ≥ 3.0V
Data Hold Time (t <sub>HD; DAT</sub> )	50			ns	V <sub>DD</sub> ≥ 1.4V
	30				V <sub>DD</sub> ≥ 1.8V
	20				V <sub>DD</sub> ≥ 3.0V
Data Valid Time (t <sub>VD; DAT</sub> )	4.0			μs	V <sub>DD</sub> ≥ 1.4V
	1.5				V <sub>DD</sub> ≥ 1.8V
	1.2				V <sub>DD</sub> ≥ 3.0V
Data Valid Acknowledge Time (t <sub>VD; ACK</sub> )	3.5			μs	V <sub>DD</sub> ≥ 1.4V
	1.1				V <sub>DD</sub> ≥ 1.8V
	0.9				V <sub>DD</sub> ≥ 3.0V

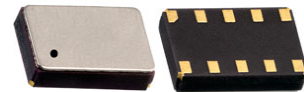

(Continued)

Parameters	Min.	Typ.	Max.	Units	Conditions
Stop Condition Set-up Time ( $t_{SU; STO}$ )	50			ns	$V_{DD} \geq 1.4V$
	30				$V_{DD} \geq 1.8V$
	20				$V_{DD} \geq 3.0V$
Bus Free Time between STOP and START Condition ( $t_{BUF}$ )	1.0			$\mu s$	$V_{DD} \geq 1.4V$
	0.5				$V_{DD} \geq 1.8V$
	0.4				$V_{DD} \geq 3.0V$
SCL "LOW time" ( $t_{LOW}$ )	4.5			$\mu s$	$V_{DD} \geq 1.4V$
	1.7				$V_{DD} \geq 1.8V$
	1.3				$V_{DD} \geq 3.0V$
SCL "High time" ( $t_{HIGH}$ )	0.6			$\mu s$	$V_{DD} \geq 1.4V$
	0.5				$V_{DD} \geq 1.8V$
	0.4				$V_{DD} \geq 3.0V$
SCL and SDA Rise Time ( $t_r$ )			1.0	$\mu s$	$V_{DD} \geq 1.4V$
			0.3		$V_{DD} \geq 1.8V$
			0.2		$V_{DD} \geq 3.0V$
SCL and SDA Fall Time ( $t_f$ )			0.4	$\mu s$	$V_{DD} \geq 1.4V$
			0.3		$V_{DD} \geq 1.8V$
			0.2		$V_{DD} \geq 3.0V$
Tolerance Spike Time on Bus ( $t_{SP}$ )			50	ns	
SCL and SDA I/O Capacitance ( $C_{I/O}$ )			10	pF	
Capacitive Load Bus Lines ( $C_B$ )			200	pF	

## I<sup>2</sup>C Interface Timing Characteristics

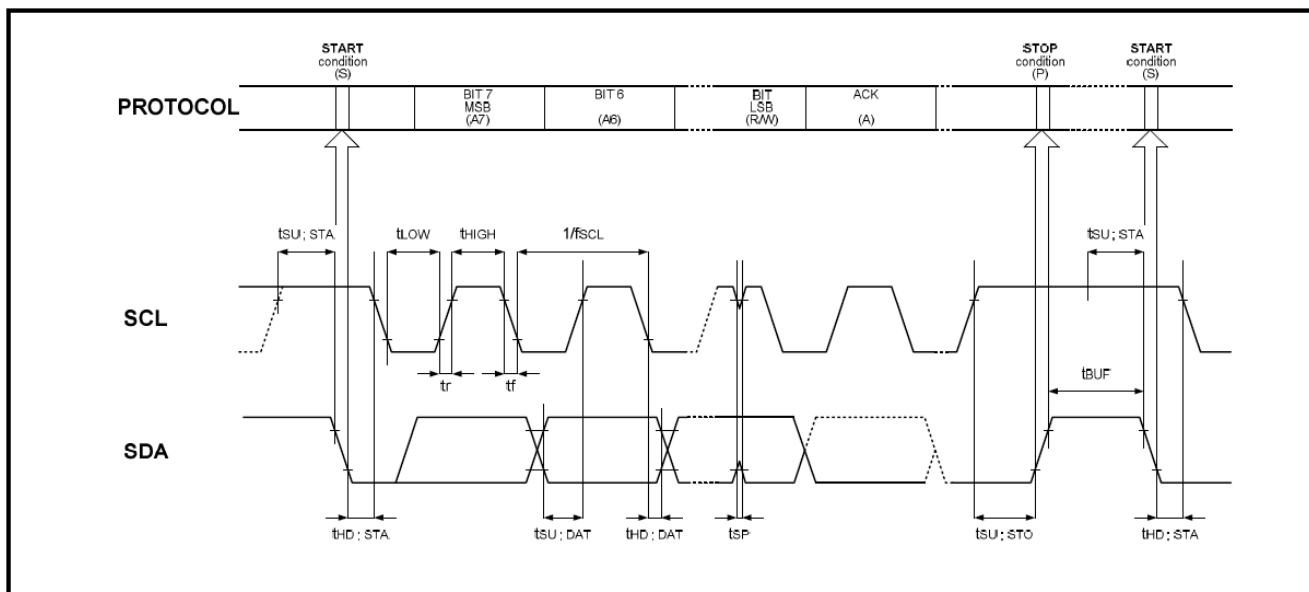

# DTCXO Temperature Compensated Real Time Clock Module with I<sup>2</sup>C Bus

AB-RTCMC-32.768kHz-EOZ9-S3



RoHS/RoHS II compliant

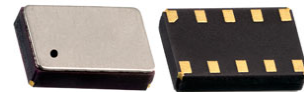

3.7 x 2.5 x 0.9 mm

## PART IDENTIFICATIONS:

AB-RTCMC-32.768 kHz-EOZ9-S3-

Operating Temp. Range
D: -40 ~ +85°C
H: -40 ~ +125°C

Timing Accuracy
A: see Table 1 below
B: see Table 1 below

Packaging
Blank: Bulk
T: 1000pcs/reel

Table 1. Time accuracy, DTCXO Digitally Temperature Compensated

Parameters		Min.	Typ.	Max.	Units
Time Accuracy Option: A	T <sub>AMB</sub> =+25°C		±1	±3	ppm
	T <sub>AMB</sub> =0 ~ +50°C		±2	±4	
	T <sub>AMB</sub> =-10 ~ +65°C		±3	±5	
	T <sub>AMB</sub> =-40 ~ +85°C		±4	±6	
	T <sub>AMB</sub> =-40 ~ +125°C		±5	±8	
Time Accuracy Option: B	T <sub>AMB</sub> =+25°C		±1	±3	ppm
	T <sub>AMB</sub> =0 ~ +50°C		±3	±5	
	T <sub>AMB</sub> =-10 ~ +65°C		±5	±10	
	T <sub>AMB</sub> =-40 ~ +85°C		±10	±25	
	T <sub>AMB</sub> =-40 ~ +125°C		±15	±30	

## OUTLINE DIMENSIONS:

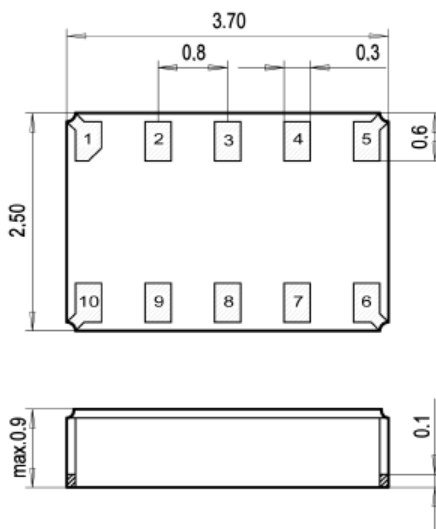

### Recommended Land Pattern

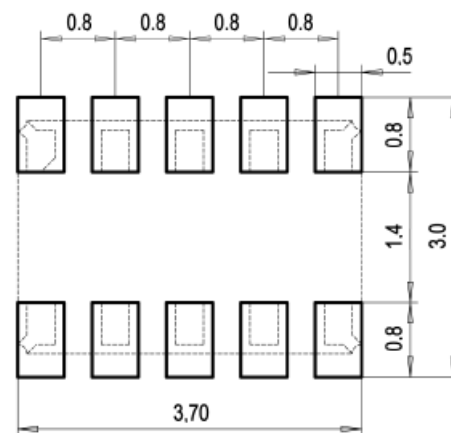

Dimensions: mm

# DTCXO Temperature Compensated Real Time Clock Module with I<sup>2</sup>C Bus

AB-RTCMC-32.768kHz-EOZ9-S3



RoHS/RoHS II compliant

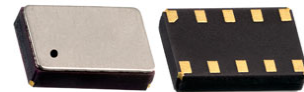

3.7 x 2.5 x 0.9 mm

## PIN DESCRIPTIONS:

Pin No.	Pin Name	Function
1	CLKOE	CLKOUT enable/disable pin; enable is active HIGH; tie to GND when not using CLKOUT
2	V <sub>DD</sub>	Positive supply voltage; positive or negative steps in supply voltage may affect oscillator performance, recommend 10 nF decoupling capacitor close to device
3	CLKOUT	Clock Output pin; CLKOUT or $\overline{\text{INT}}$ function can be selected.(Control_1; bit7; Clk/Int) CLKOUT output push-pull / $\overline{\text{INT}}$ function open-drain requiring pull-up resistor
4	SCL	Serial Clock Input pin; requires pull-up resistor
5	SDA	Serial Data Input-Output pin; open-drain; requires pull-up resistor
6	V <sub>SS</sub>	Ground
7	$\overline{\text{INT}}$	Interrupt output pin; open-drain; active LOW
8	N.C.	Not connected; internally used for test. do not connect other signals than ground
9	V <sub>BACKUP</sub>	Backup Supply Voltage; tie to GND when not using backup supply voltage
10	N.C.	Not connected; internally used for test. do not connect other signals than ground

## BLOCK DIAGRAM:

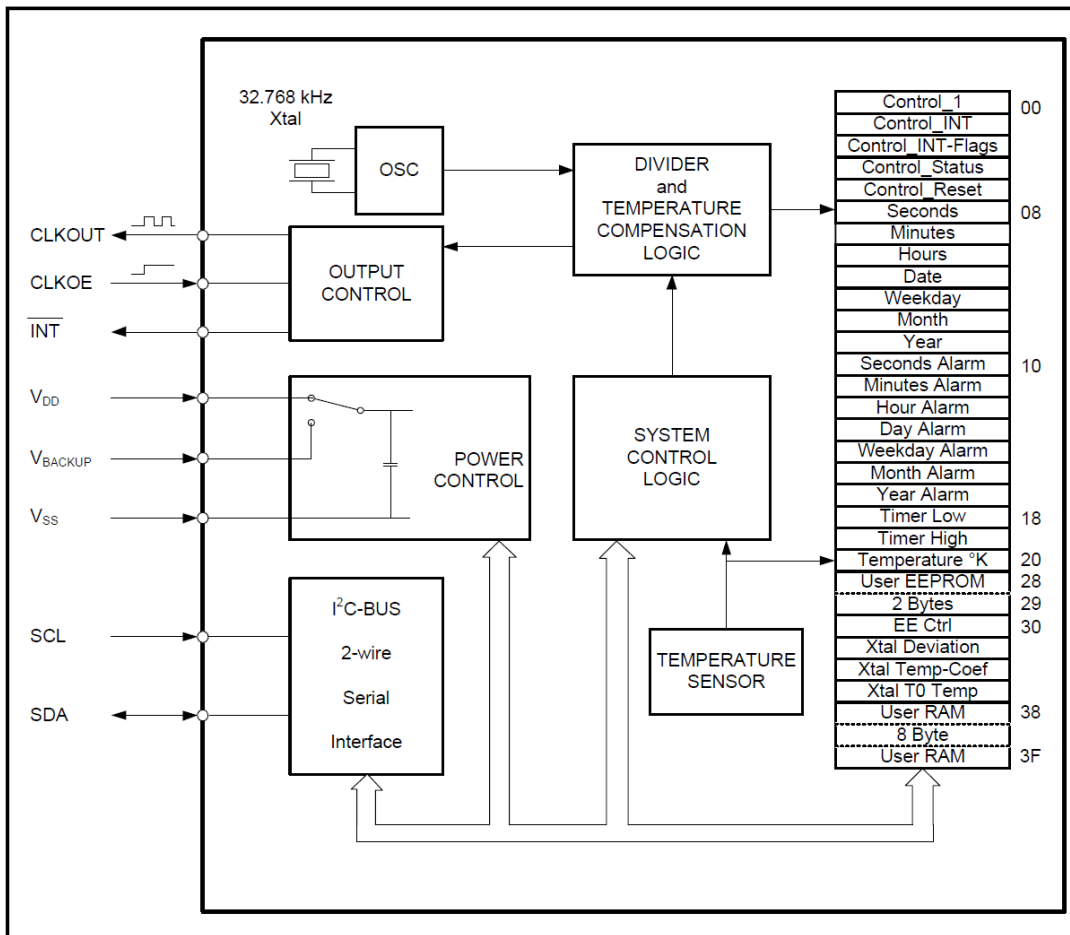



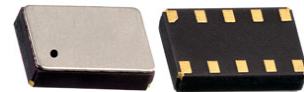

## RECOMMENDED REFLOW PROFILE:

Maximum Reflow Conditions in accordance with IPC/JEDEC J-STD-020C “Pb-free”

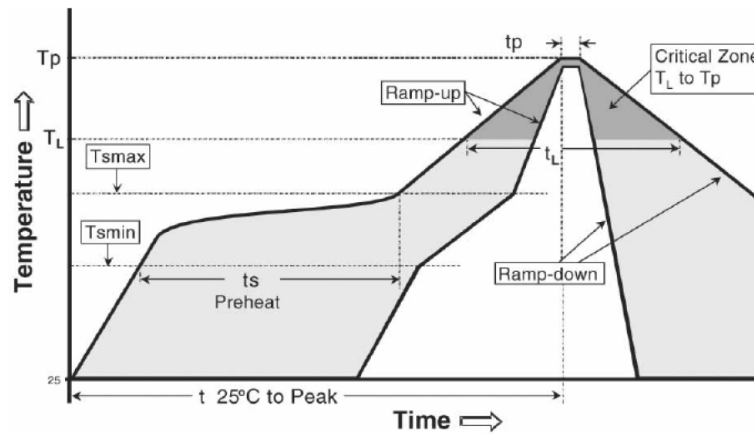

Temperature	Conditions	Units
Average Ramp-up Rate ( $T_{Smax}$ to $T_p$ )	3°C/second max	°C/s
Ramp Down Rate ( $T_{cool}$ )	6°C/second max	°C/s
Time 25°C to Peak Temperature ( $T_{to-peak}$ )	8 minutes max	m
<b>Preheat</b>		
Temperature Min ( $T_{Smin}$ )	150	°C
Temperature Max ( $T_{Smax}$ )	200	°C
Time $T_{Smin}$ to $T_{Smax}$ ( $t_s$ )	60 ~ 180	sec
<b>Time Above Liquidus</b>		
Temperature Liquidus ( $T_L$ )	217	°C
Time above Liquidus ( $t_l$ )	60 ~ 150	sec
<b>Peak Temperature</b>		
Peak Temperature ( $T_p$ )	260	°C
Time within 5°C of Peak Temperature ( $t_p$ )	20 ~ 40	sec

# DTCXO Temperature Compensated Real Time Clock Module with I<sup>2</sup>C Bus

AB-RTCMC-32.768kHz-EOZ9-S3



RoHS/RoHS II compliant



3.7 x 2.5 x 0.9 mm

## TAPE & REEL:

T = 1000pcs/reel

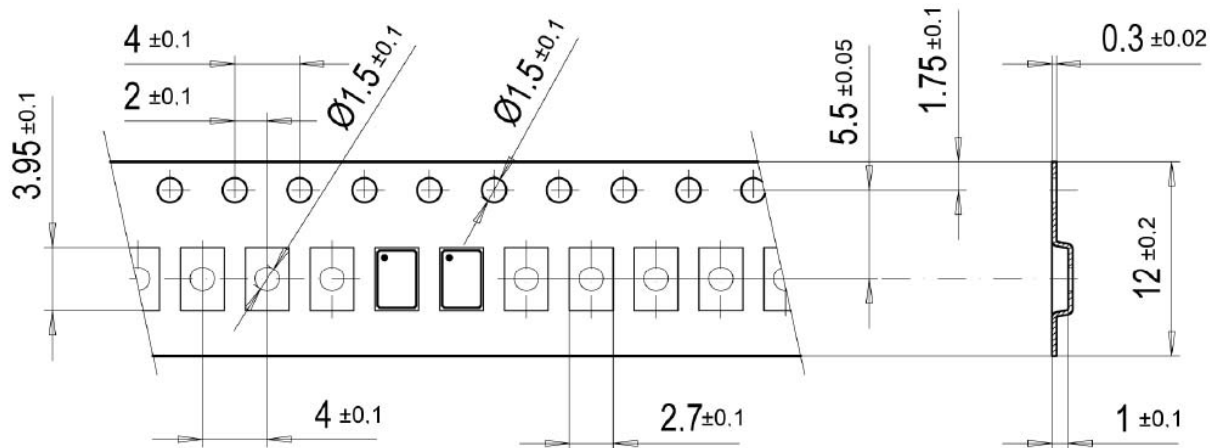

User Direction of Feed

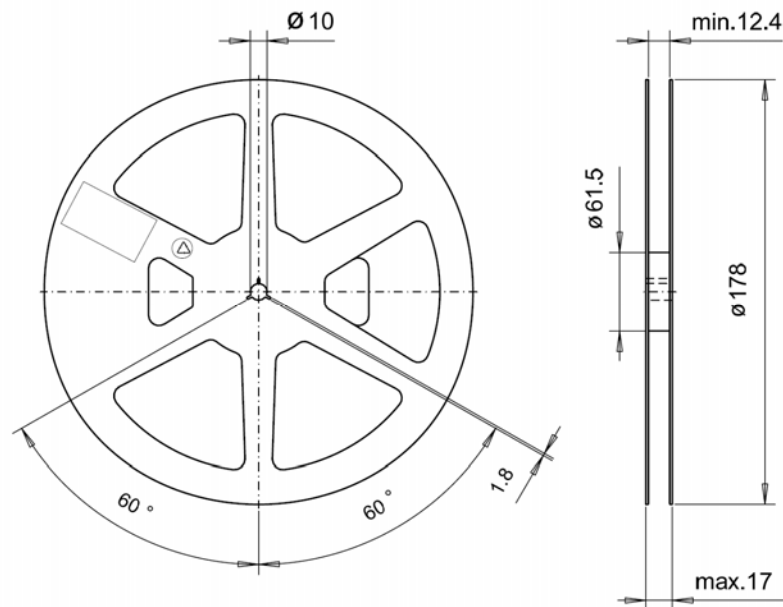

Dimension: mm

**ATTENTION:** Abracon LLC's products are COTS – Commercial-Off-The-Shelf products; suitable for Commercial, Industrial and, where designated, Automotive Applications. Abracon's products are not specifically designed for Military, Aviation, Aerospace, Life-dependant Medical applications or any application requiring high reliability where component failure could result in loss of life and/or property. For applications requiring high reliability and/or presenting an extreme operating environment, written consent and authorization from Abracon LLC is required. Please contact Abracon LLC for more information.