

LOW VOLTAGE DC MOTOR CONTROLLER

■ GENERAL DESCRIPTION

The **NJM2606/06A** are integrated circuits with wide operating supply voltage range for DC motor speed control. Especially, the **NJM2606A** is suited for the applications requiring low saturation output voltage.

■ PACKAGE OUTLINE

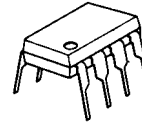

NJM2606D
NJM2606AD



NJM2606M
NJM2606AM

■ FEATURES

- Operating Voltage (1.8V to 8V)
- Internal Low Saturation Voltage Output Transistor
- Package Outline DIP8, DMP8
- Bipolar Technology

■ PIN CONFIGURATION

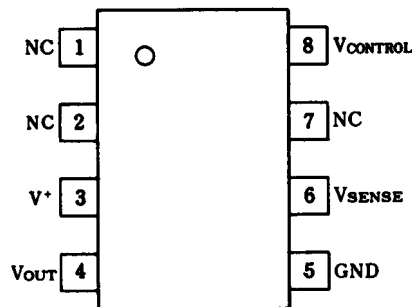

NJM2606D
NJM2606AD
NJM2606M
NJM2606AM

■ BLOCK DIAGRAM

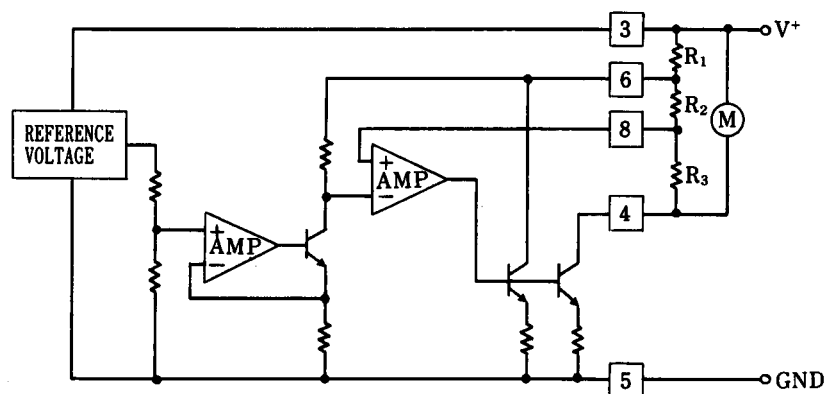

NJM2606 / 2606A

■ ABSOLUTE MAXIMUM RATINGS

($T_a=25^{\circ}\text{C}$)

PARAMETER	SYMBOL	RATINGS	UNIT
Supply Voltage	V^+	10	V
Peak-to-peak Output Current	I_{OP}	700	mA
Power Dissipation	P_D	(DIP) 500	mW
		(DMP8) 300	mW
Operating Temperature Range	T_{opr}	-20 to 75	$^{\circ}\text{C}$
Storage Temperature Range	T_{stg}	-40 to 125	$^{\circ}\text{C}$

(note)At SW ON. (3 sec. at motor locked or 100msec at duty factor less than 0.1%)

■ ELECTRICAL CHARACTERISTICS

($T_a=25^{\circ}\text{C}$, $V^+=3\text{V}$, $I_M=100\text{mA}$)

PARAMETER	SYMBOL	TEST CONDITION	MIN.	TYP.	MAX.	UNIT
Operating Current	I_{CC}		-	2.4	6.0	mA
Output Saturation Voltage						
NJM2606	V_{OSAT}		-	0.18	0.3	V
NJM2606A	V_{OSAT}		-	0.13	0.18	V
Reference Voltage	V_{REF}		0.18	0.20	0.22	V
vs. Operating Voltage	ΔV_{RSV}	$V^+=1.8\text{V to }8.0\text{V}$	-	0.7	8.0	mV
vs. Output Current	ΔV_{ROC}	$I_M=20\text{mA to }200\text{mA}$	-	2.7	9.0	mV
vs. Ambient Temperature	ΔV_{RT}	$T_a=-20^{\circ}\text{C to }+75^{\circ}\text{C}$	-	0.04	-	mV / $^{\circ}\text{C}$
Current Ratio	K	$I_M=50\text{mA to }150\text{mA}$	45	50	55	
vs. Operating Voltage	ΔK_{SV}	$V^+=1.8\text{V to }8.0\text{V}$ $I_M=50\text{mA to }150\text{mA}$	-	0.6	3.0	
vs. Output Current	ΔK_{OC}	$I_M=(20\text{ to }50)\text{mA to } (170\text{ to }200)\text{mA}$	-	1.0	4.0	
vs. Ambient Temperature	ΔK_{TC}	$T_a=-20^{\circ}\text{C to }+75^{\circ}\text{C}$ $I_M=50\text{mA to }150\text{mA}$	-	1.0	-	1 / $^{\circ}\text{C}$

■ TYPICAL CHARACTERISTICS

Reference Voltage vs. Operating Voltage

($I_M=100\text{mA}$, $T_a=25^\circ\text{C}$)

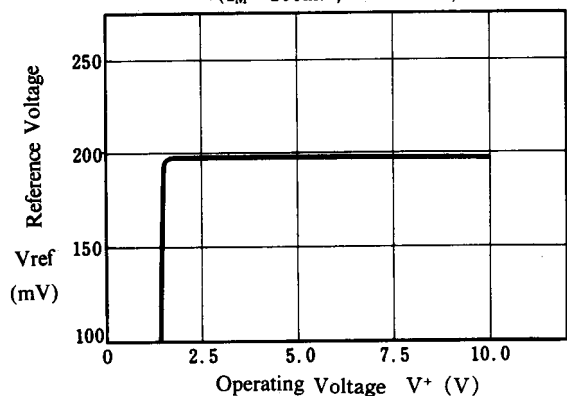

Reference Voltage vs. Motor Current

($V^+=3\text{V}$, $T_a=25^\circ\text{C}$)

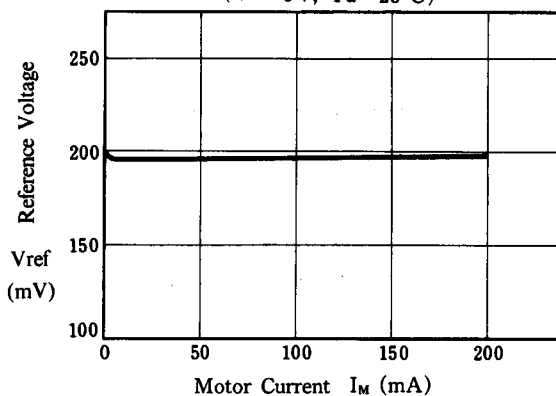

Reference Voltage vs. Temperature

($V^+=3\text{V}$)

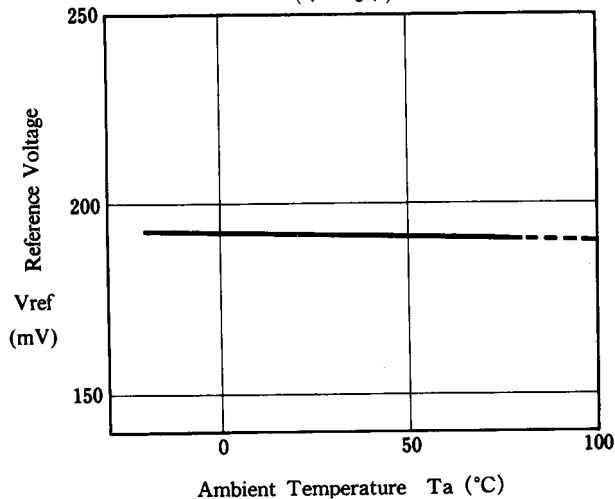

Operating Current vs. Operating Voltage

($T_a=25^\circ\text{C}$)

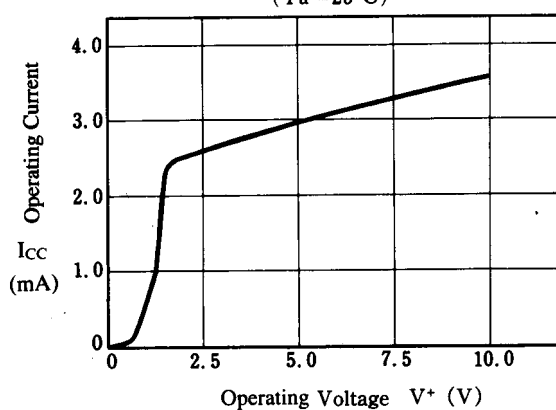

Output Saturation Voltage vs. Motor Current

($V^+=3\text{V}$, $T_a=25^\circ\text{C}$)

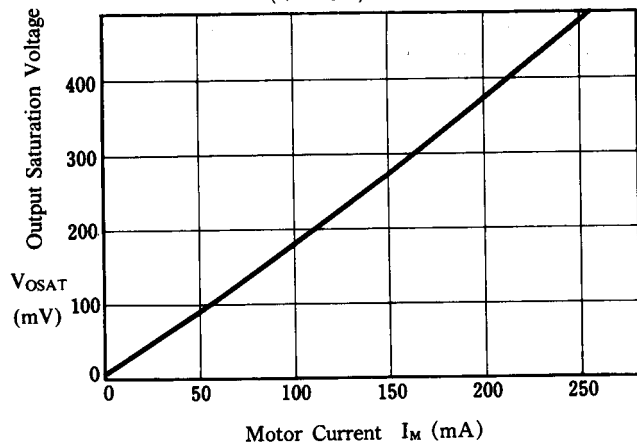

Current Ratio vs. Operating Voltage

($I_M=50-150\text{mA}$, $T_a=25^\circ\text{C}$)

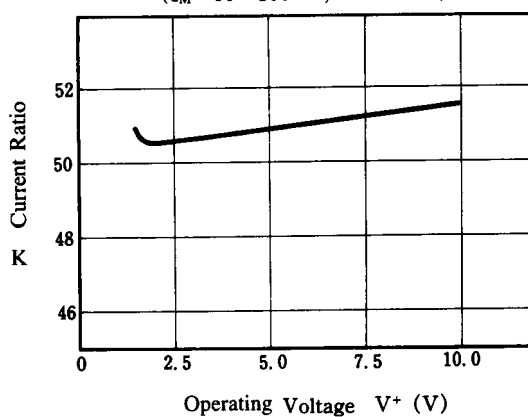

NJM2606 / 2606A

■ TYPICAL CHARACTERISTICS

Current Ratio vs. Motor Current

($V^+ = 3V$, $T_a = 25^\circ C$)

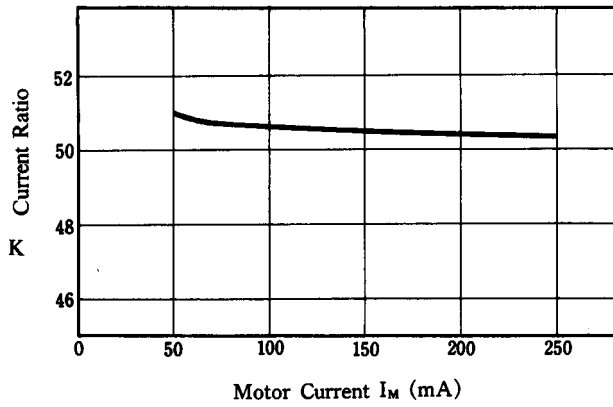

Current Ratio vs. Temperature

($V^+ = 3V$, $I_M = 50 \sim 150mA$)

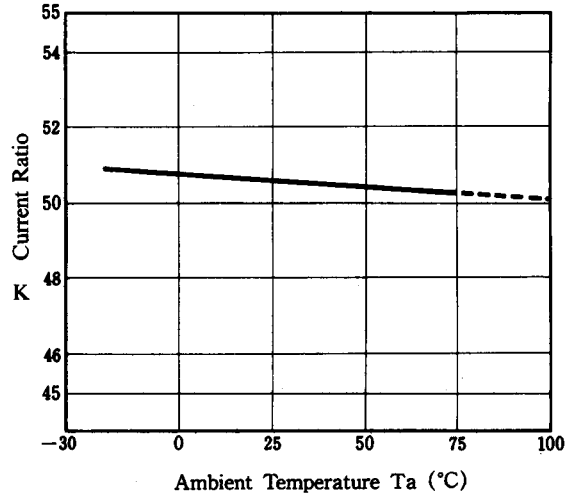

Rotation vs. Torque

($V^+ = 3V$, $T_a = 25^\circ C$)

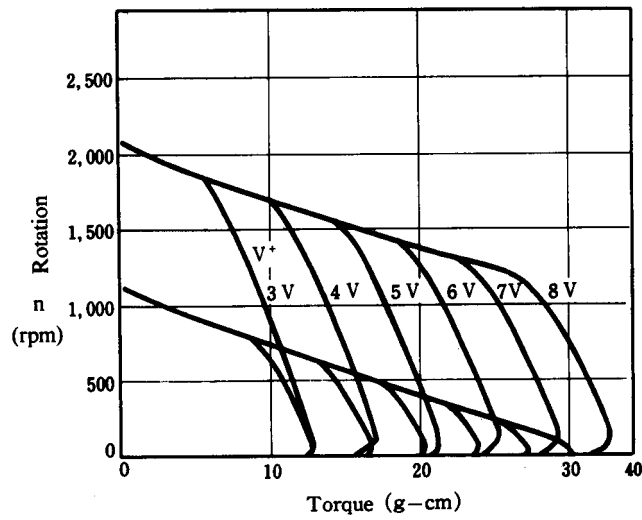

■ TYPICAL APPLICATION

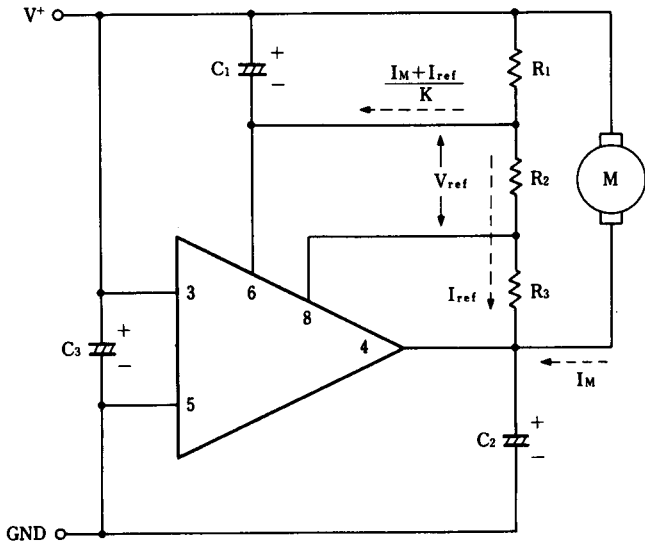

Select C₁, C₂, C₃ for each motor type.

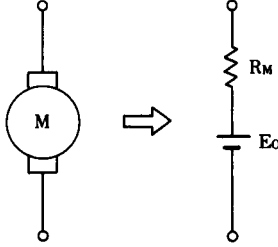

- V_{ref} : Reference Voltage
- K : Current Ratio
- I_M : Motor Current
- R_M : Internal Resistance of Motor
- E_O : Motor Counter Electromotive Voltage

The voltage applied at the motor is set as V_M, which brings the following formula.

$$V_M = (R_1 + R_2 + R_3) I_{ref} + R_1 \cdot \frac{I_M + I_{ref}}{K}$$

Now that, I_{ref} = V_{ref} / R₂ so that, (I_{ref} ≐ 100μA setting is appropriate)

$$V_M = \frac{V_{ref}}{R_2} (R_1 + \frac{R_1}{K} + R_2 + R_3) + \frac{R_1}{K} I_M \quad (1)$$

On the other hand, the voltage applied at the motor itself will be as in the following.

$$V_M = E_O + R_M \cdot I_M \quad (2)$$

Through (1), (2), and then leading to stabilize the control system.

$$R_M \cdot I_M > \frac{R_1}{K} \cdot I_M$$

$$\therefore R_1 < K \cdot R_M \quad (3)$$

Taking in consideration of deviations, R_{1(MAX)} < K_(MIN) · R_{M(MIN)} with the condition.

Items required checking in regard to the temperature coefficient

IC items

1. Reference voltage : Temperature coefficient of V_{ref}.
2. Current Ratio : Temperature coefficient of K
*1 External component items
3. Temperature coefficient of R₁, R₂ and R₃
The relation among these 3 parts takes the very important roll.
4. Temperature coefficient of motor internal resistance
5. Temperature coefficient of motor generative voltage
6. Temperature coefficient ratio of R₁ and R_M
Count up from 3.4.

[CAUTION]
The specifications on this databook are only given for information, without any guarantee as regards either mistakes or omissions. The application circuits in this databook are described only to show representative usages of the product and not intended for the guarantee or permission of any right including the industrial rights.