

GenX3™ 1200V IGBT

IXGH30N120B3D1 IXGT30N120B3D1

High speed Low V_{sat} PT
IGBTs 3-20 kHz switching



V_{CES} = 1200V
I_{C110} = 30A
V_{CE(sat)} ≤ 3.5V
t_{fi(typ)} = 204ns

Symbol	Test Conditions	Maximum Ratings	
V_{CES}	T _J = 25°C to 150°C	1200	V
V_{CGR}	T _J = 25°C to 150°C, R _{GE} = 1MΩ	1200	V
V_{GES}	Continuous	±20	V
V_{GEM}	Transient	±30	V
I_{C110}	T _C = 110°C	30	A
I_{F110}	T _C = 110°C	28	A
I_{CM}	T _C = 25°C, 1ms	150	A
SSOA (RBSOA)	V _{GE} = 15V, T _{VJ} = 125°C, R _G = 5Ω Clamped inductive load	I _{CM} = 60 @ 0.8 • V _{CE}	A
P_c	T _C = 25°C	300	W
T_J		-55 ... +150	°C
T_{JM}		150	°C
T_{stg}		-55 ... +150	°C
M_d	Mounting torque (TO-247)	1.13 / 10	Nm/lb.in.
T_L	Maximum lead temperature for soldering	300	°C
T_{SOLD}	1.6mm (0.062 in.) from case for 10s	260	°C
Weight	TO-247	6	g
	TO-268	4	g

TO-247 AD (IXGH)

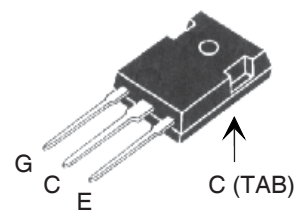

TO-268 (IXGT)

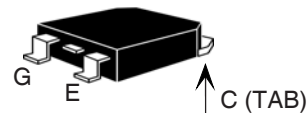

G = Gate C = Collector
E = Emitter TAB = Collector

Features

- Optimized for low conduction and switching losses
- Square RBSOA
- Anti-parallel ultra fast diode
- International standard packages

Advantages

- High power density
- Low gate drive requirement

Applications

- Power Inverters
- UPS
- Motor Drives
- SMPS
- PFC Circuits
- Welding Machines

Symbol	Test Conditions	Characteristic Values (T _J = 25°C, unless otherwise specified)		
		Min.	Typ.	Max.
V_{GE(th)}	I _C = 250μA, V _{CE} = V _{GE}	3.0		5.0 V
I_{CES}	V _{CE} = V _{CES} V _{GE} = 0V T _J = 125°C			300 μA 1.5 mA
I_{GES}	V _{CE} = 0V, V _{GE} = ±20V			±100 nA
V_{CE(sat)}	I _C = 30A, V _{GE} = 15V, Note 1 T _J = 125°C	2.96 2.95	3.5	V V

Symbol	Test Conditions	Characteristic Values		
		Min.	Typ.	Max.
g_{fs}	$I_C = 30A, V_{CE} = 10V, \text{Note 1}$	11	19	S
C_{ies} C_{oes} C_{res}	$V_{CE} = 25V, V_{GE} = 0V, f = 1MHz$		1750	pF
			120	pF
			46	pF
Q_g Q_{ge} Q_{gc}	$I_C = 30A, V_{GE} = 15V, V_{CE} = 0.5 \cdot V_{CES}$		87	nC
			15	nC
			39	nC
$t_{d(on)}$ t_{ri} E_{on} $t_{d(off)}$ t_{fi} E_{off}	Inductive load, $T_J = 25^\circ C$ $I_C = 30A, V_{GE} = 15V, \text{Notes 2}$ $V_{CE} = 0.8 \cdot V_{CES}, R_G = 5\Omega$		16	ns
			37	ns
			3.47	mJ
			127	200 ns
			204	380 ns
			2.16	4.0 mJ
$t_{d(on)}$ t_{ri} E_{on} $t_{d(off)}$ t_{fi} E_{off}	Inductive load, $T_J = 125^\circ C$ $I_C = 30A, V_{GE} = 15V, \text{Notes 2}$ $V_{CE} = 0.8 \cdot V_{CES}, R_G = 5\Omega$		18	ns
			38	ns
			6.70	mJ
			216	ns
			255	ns
			5.10	mJ
R_{thJC} R_{thCS}		0.21	0.42 $^\circ C/W$ $^\circ C/W$	

Reverse Diode (FRED)

Symbol	Test Conditions	Characteristic Values		
		Min.	Typ.	Max.
V_F	$I_F = 30A, V_{GE} = 0V, \text{Note 1}$			2.8 V
	$T_J = 150^\circ C$		1.6	V
I_{RM} t_{rr}	$I_F = 30A, V_{GE} = 0V, -di_F/dt = 100A/\mu s, V_R = 300V$			4 A
		$T_J = 100^\circ C$	100	
R_{thJC}				0.9 $^\circ C/W$

Note 1: Pulse test, $t \leq 300\mu s$, duty cycle, $d \leq 2\%$.

2. Switching times may increase for V_{CE} (Clamp) $> 0.8 V_{CES}$, higher T_J or increased R_G .

TO-247 AD Outline

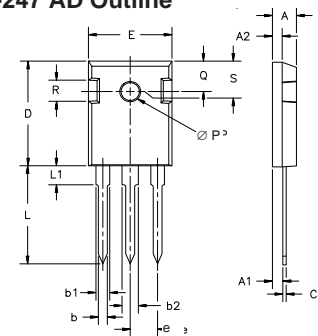

Dim.	Millimeter		Inches	
	Min.	Max.	Min.	Max.
A	4.7	5.3	.185	.209
A ₁	2.2	2.54	.087	.102
A ₂	2.2	2.6	.059	.098
b	1.0	1.4	.040	.055
b ₁	1.65	2.13	.065	.084
b ₂	2.87	3.12	.113	.123
C	.4	.8	.016	.031
D	20.80	21.46	.819	.845
E	15.75	16.26	.610	.640
e	5.20	5.72	0.205	0.225
L	19.81	20.32	.780	.800
L ₁		4.50		.177
∅P	3.55	3.65	.140	.144
Q	5.89	6.40	0.232	0.252
R	4.32	5.49	.170	.216

TO-268 Outline

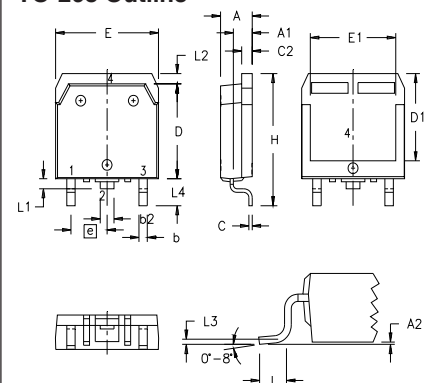

SYM	INCHES		MILLIMETERS	
	MIN	MAX	MIN	MAX
A	.193	.201	4.90	5.10
A1	.106	.114	2.70	2.90
A2	.001	.010	0.02	0.25
b	.045	.057	1.15	1.45
b2	.075	.083	1.90	2.10
C	.016	.026	0.40	0.65
C2	.057	.063	1.45	1.60
D	.543	.551	13.80	14.00
D1	.488	.500	12.40	12.70
E	.624	.632	15.85	16.05
E1	.524	.535	13.30	13.60
e	.215 BSC		5.45 BSC	
H	.736	.752	18.70	19.10
L	.094	.106	2.40	2.70
L1	.047	.055	1.20	1.40
L2	.039	.045	1.00	1.15
L3	.010 BSC		0.25 BSC	
L4	.150	.161	3.80	4.10

IXYS reserves the right to change limits, test conditions, and dimensions.

IXYS MOSFETs and IGBTs are covered by one or more of the following U.S. patents:	4,835,592	4,931,844	5,049,961	5,237,481	6,162,665	6,404,065 B1	6,683,344	6,727,585	7,005,734 B2	7,157,338B2
	4,850,072	5,017,508	5,063,307	5,381,025	6,259,123 B1	6,534,343	6,710,405 B2	6,759,692	7,063,975 B2	
	4,881,106	5,034,796	5,187,117	5,486,715	6,306,728 B1	6,583,505	6,710,463	6,771,478 B2	7,071,537	

Fig. 1. Output Characteristics @ 25°C

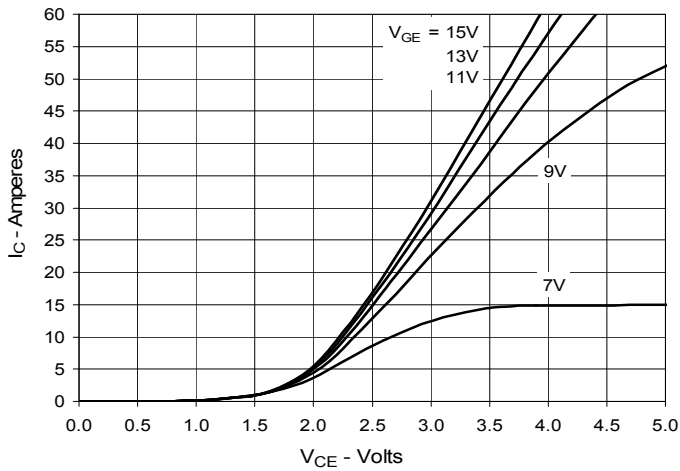

Fig. 2. Extended Output Characteristics @ 25°C

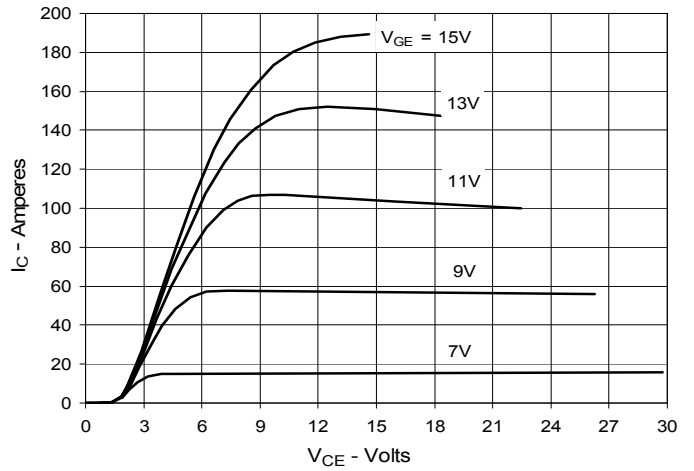

Fig. 3. Output Characteristics @ 125°C

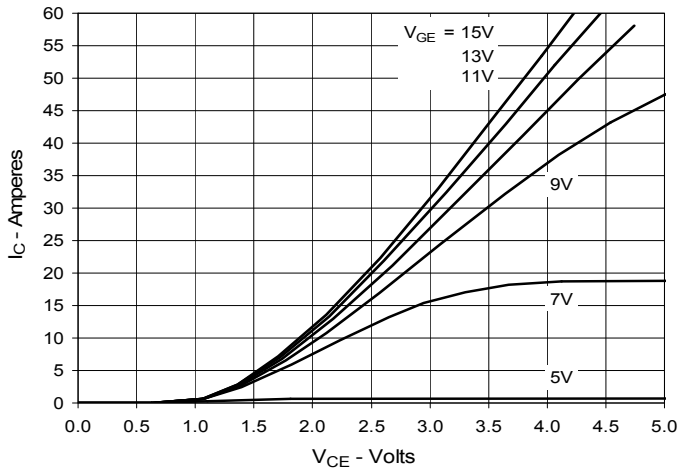

Fig. 4. Dependence of $V_{CE(sat)}$ on Junction Temperature

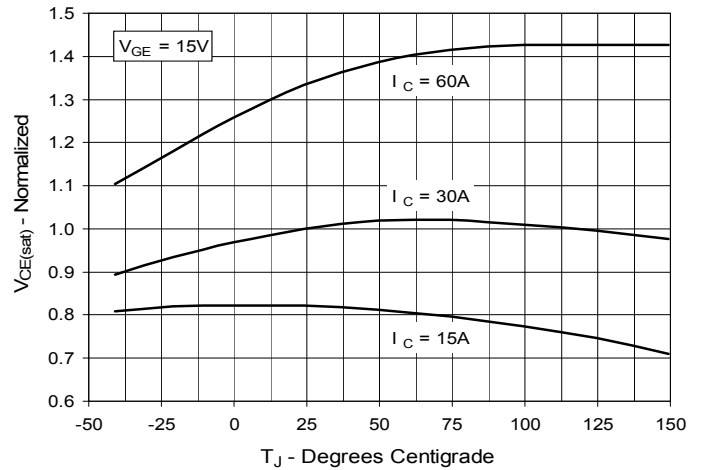

Fig. 5. Collector-to-Emitter Voltage vs. Gate-to-Emitter Voltage

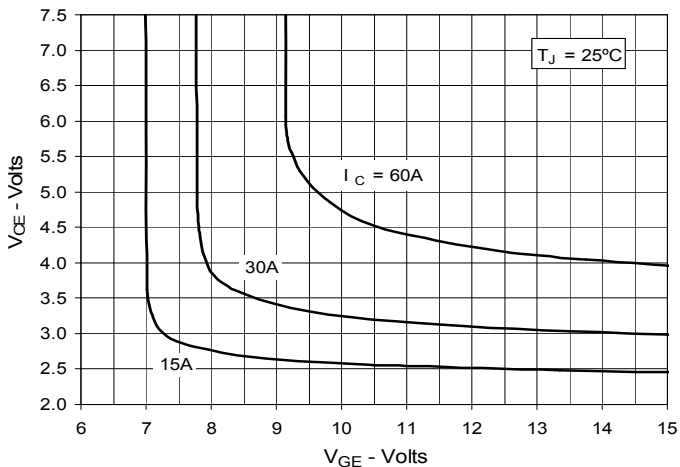

Fig. 6. Input Admittance

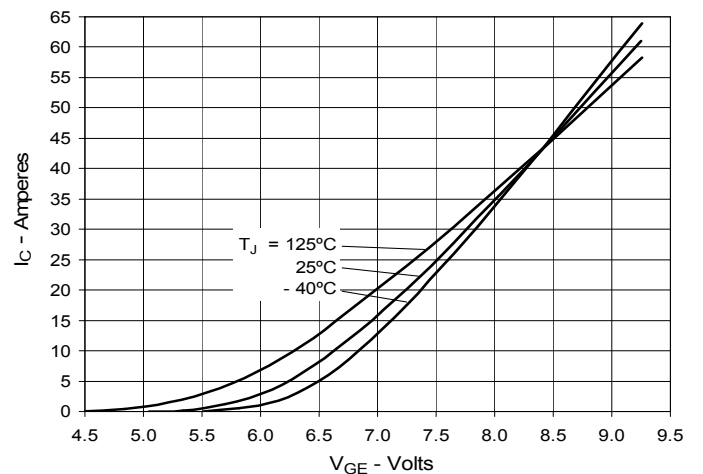

Fig. 7. Transconductance

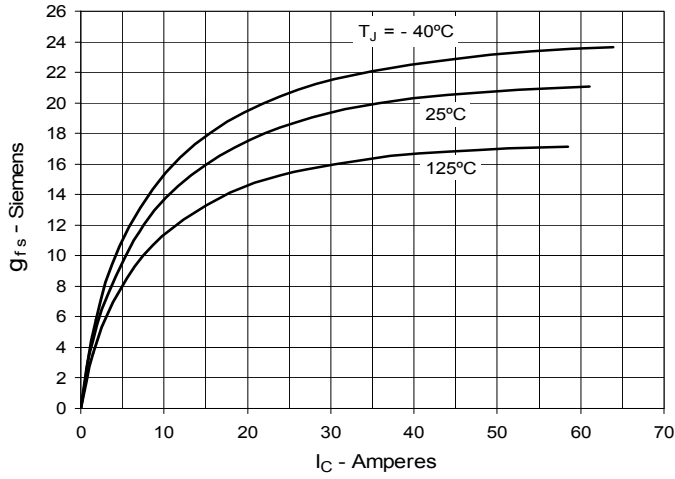

Fig. 8. Gate Charge

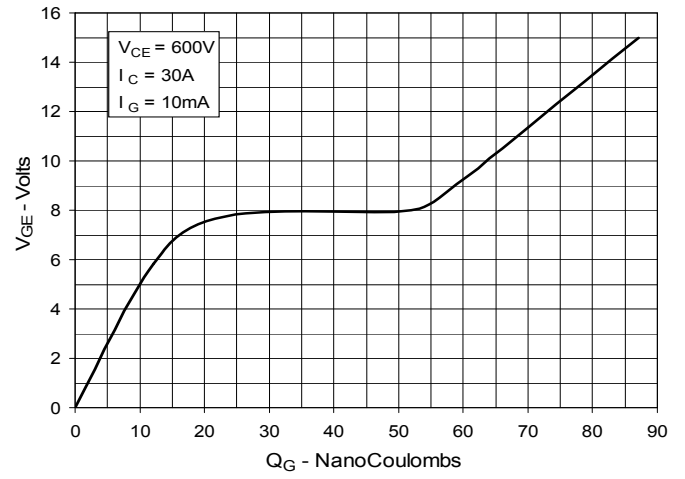

Fig. 9. Capacitance

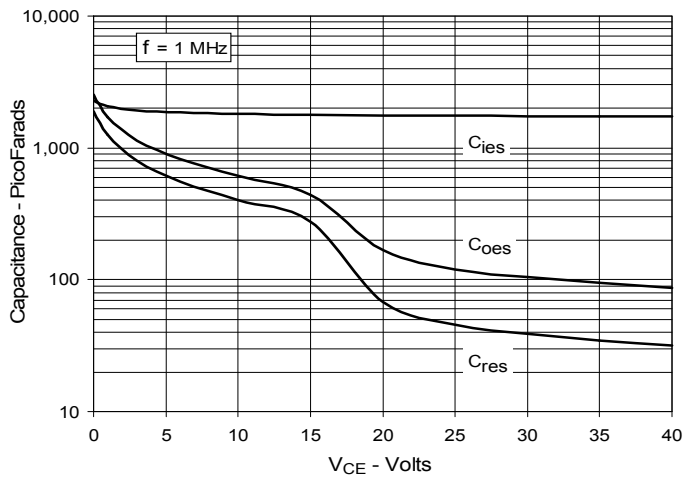

Fig. 10. Reverse-Bias Safe Operating Area

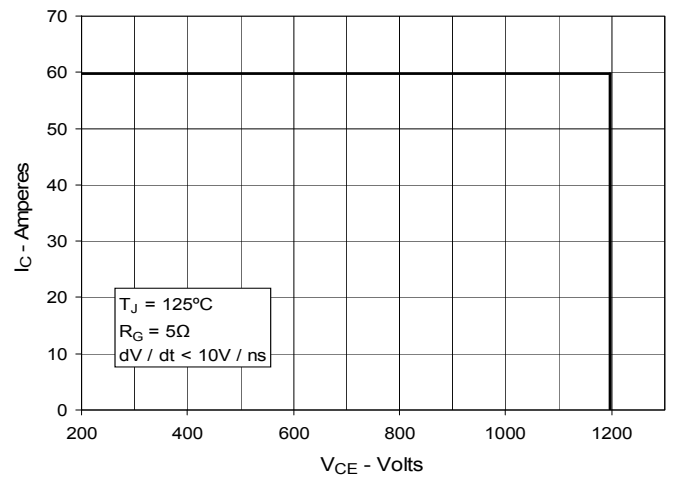

Fig. 11. Maximum Transient Thermal Impedance

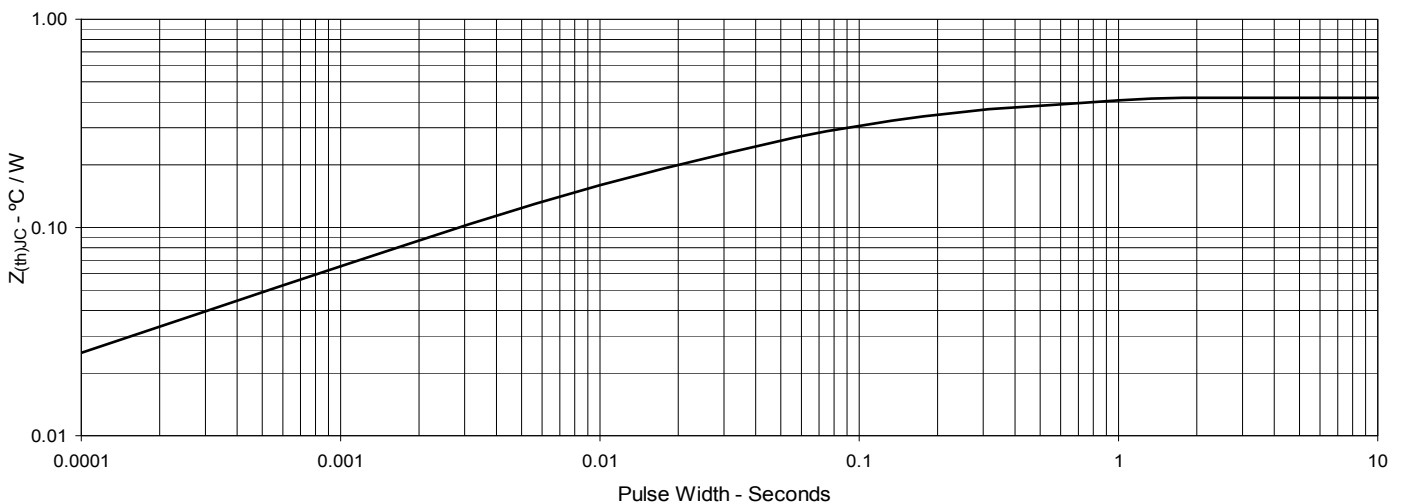

Fig. 12. Inductive Switching Energy Loss vs. Gate Resistance

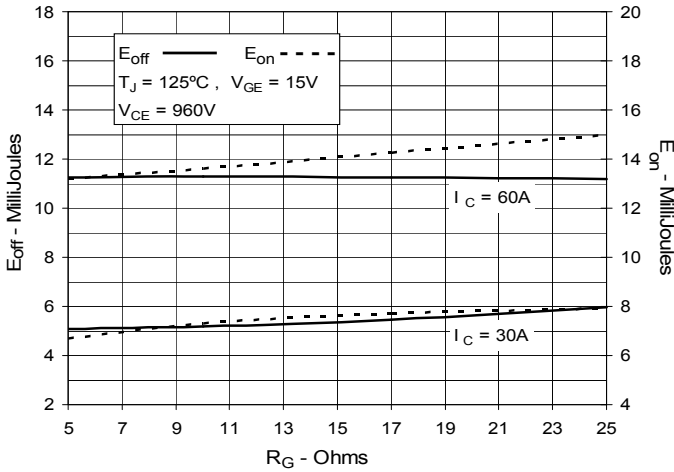

Fig. 13. Inductive Switching Energy Loss vs. Collector Current

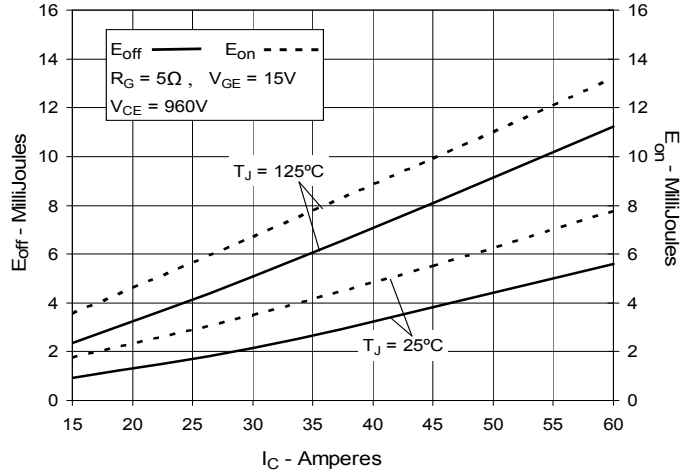

Fig. 14. Inductive Switching Energy Loss vs. Junction Temperature

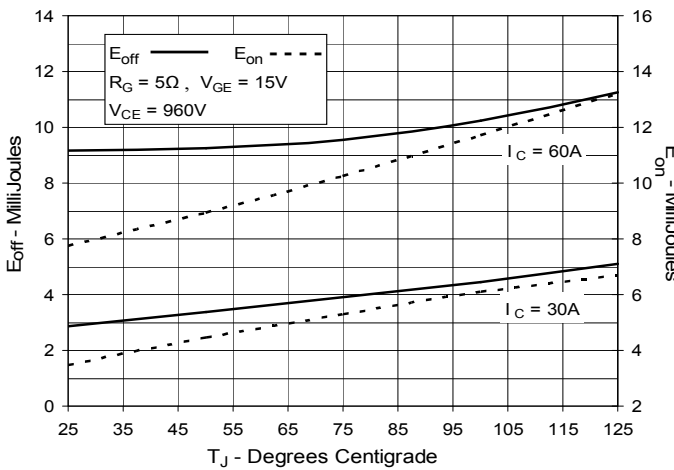

Fig. 15. Inductive Turn-off Switching Times vs. Gate Resistance

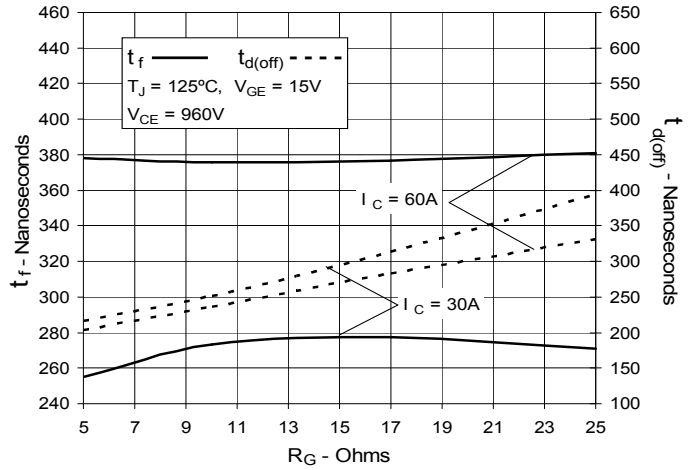

Fig. 16. Inductive Turn-off Switching Times vs. Collector Current

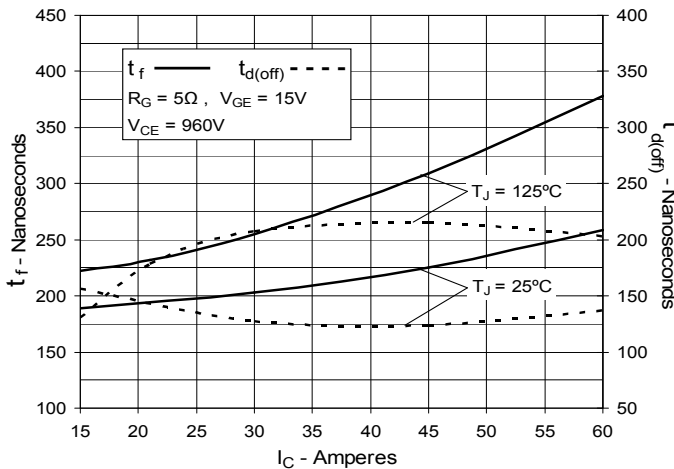
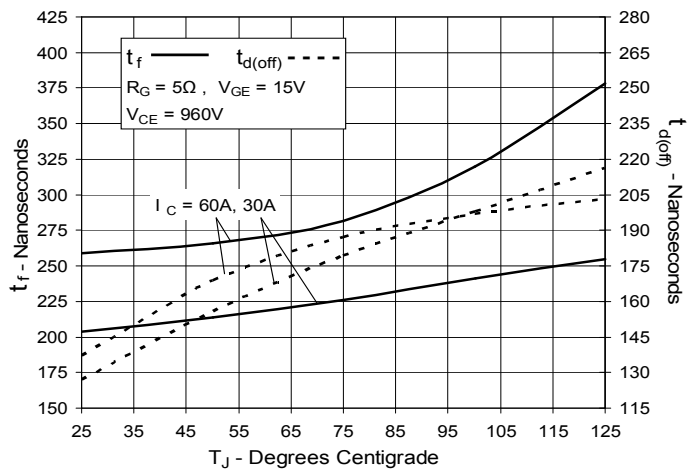
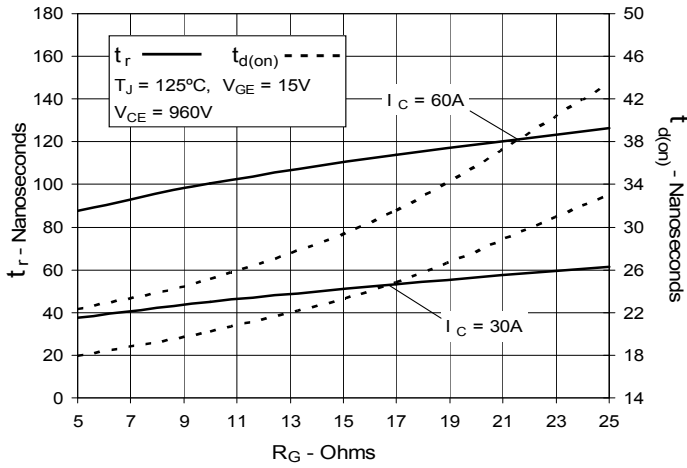

Fig. 17. Inductive Turn-off Switching Times vs. Junction Temperature



**Fig. 18. Inductive Turn-on
Switching Times vs. Gate Resistance**



**Fig. 19. Inductive Turn-on
Switching Times vs. Collector Current**

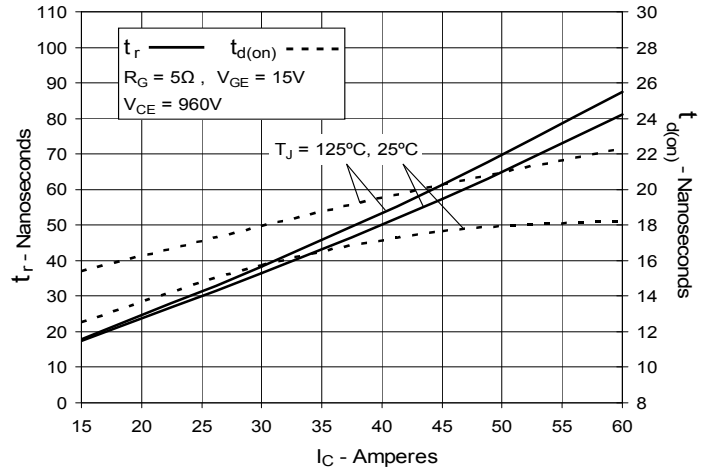

**Fig. 20. Inductive Turn-on
Switching Times vs. Junction Temperature**

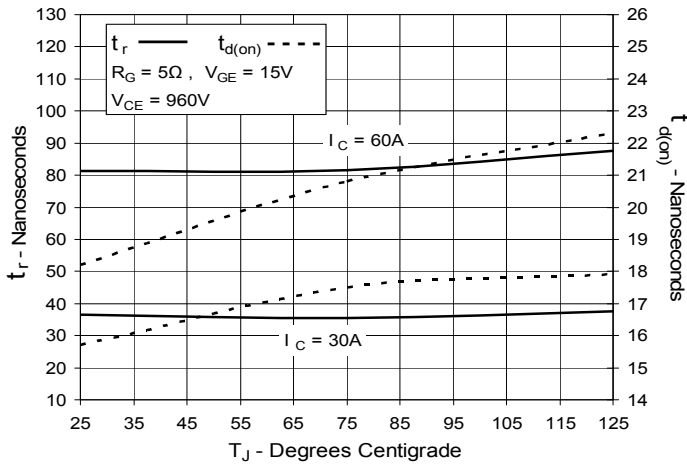

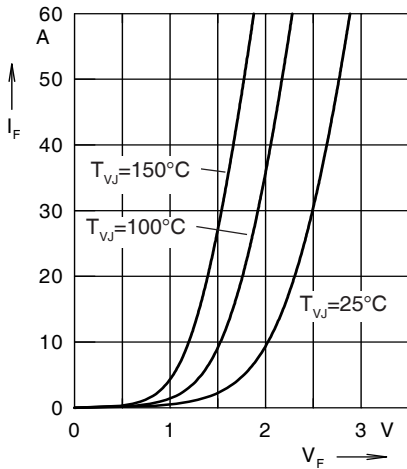

Fig. 21. Forward current I_F versus V_F

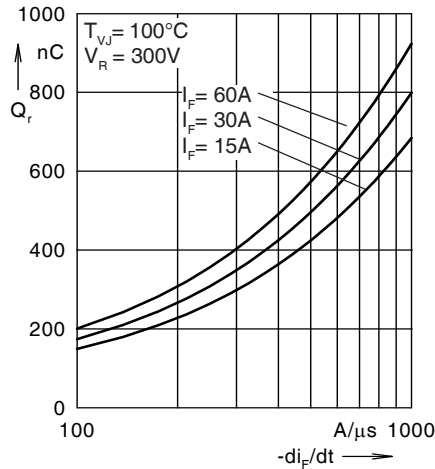

Fig. 22. Reverse recovery charge Q_r versus $-di_F/dt$

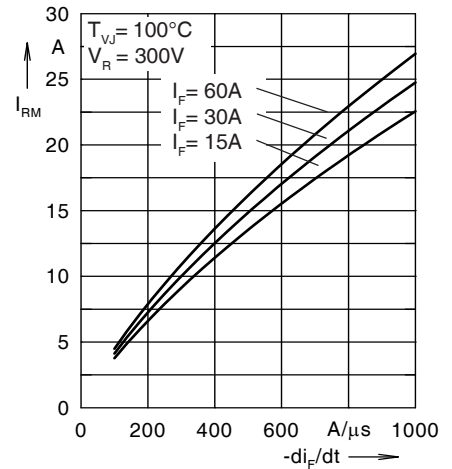

Fig. 23. Peak reverse current I_{RM} versus $-di_F/dt$

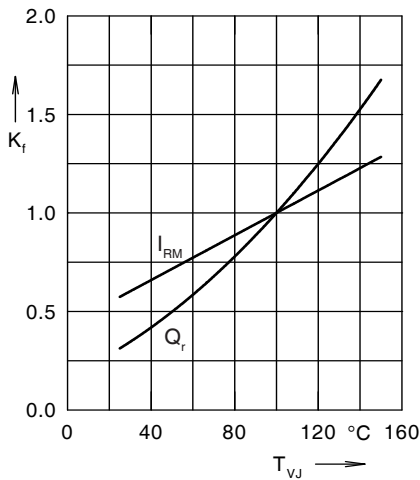

Fig. 24. Dynamic parameters Q_r , I_{RM} versus T_{VJ}

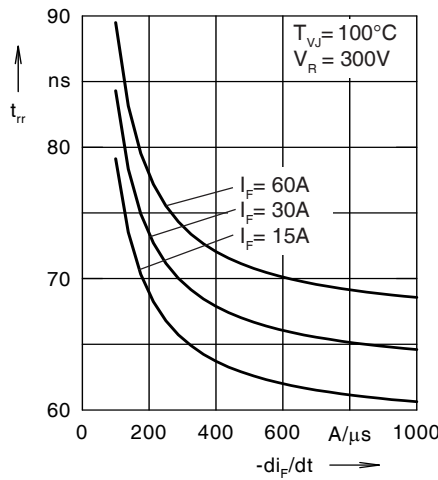

Fig. 25. Recovery time t_{rr} versus $-di_F/dt$

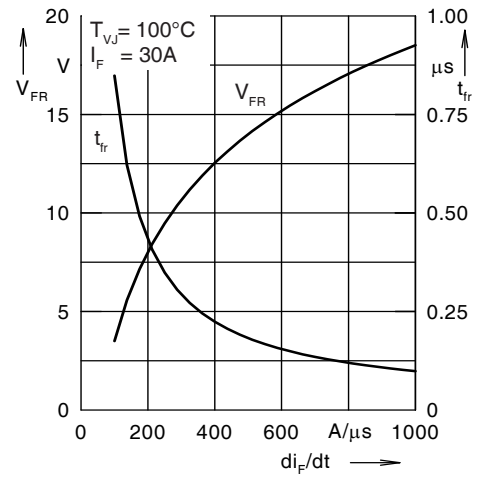

Fig. 26. Peak forward voltage V_{FR} and t_{fr} versus di_F/dt

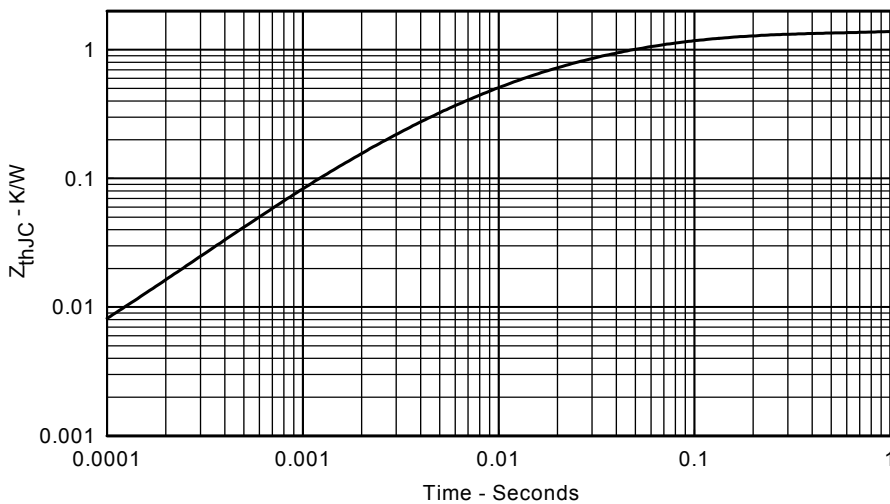

Fig. 27. Transient thermal resistance junction to case