

B45196H, Tantalum, MnO2 Tantalum, 1.5 uF, 20%, 20 V, SMD, Molded, 3216, Height Max = 1.8mm

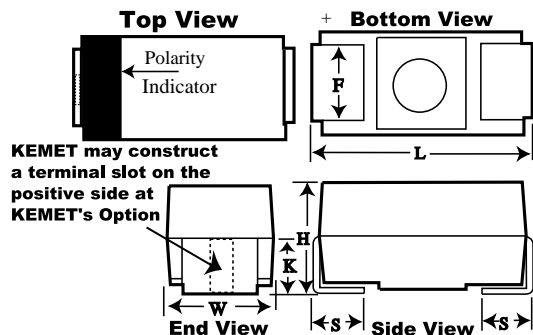

General Information	
Supplier:	KEMET
Series:	B45196H
Dielectric:	MnO2 Tantalum
Style:	SMD Chip
Description:	SMD, Molded
RoHS:	Yes
Termination:	Tin
Notes:	Obsolete. Old Part Number [Obsolete] Was B45196H4155M106

Dimensions	
Footprint	3216
L	3.2mm +/-0.2mm
W	1.6mm +/-0.2mm
H	1.6mm +/-0.2mm
S	0.8mm +/-0.3mm
F	1.2mm +/-0.1mm
K	1.3mm TYP

Specifications	
Capacitance:	1.5 uF
Capacitance Tolerance:	20%
Voltage DC:	20 VDC (85C), 13.4 VDC (125C)
Temperature Range:	-55/+125C
Rated Temperature:	85C
Dissipation Factor:	6%
Failure Rate:	N/A
Leakage Current:	0.5 uA

Packaging Specifications	
Packaging:	T&R, 330mm
Packaging Quantity:	9000