

## LTC3722, LTC4440, LTC3901, and LT1431 Isolated Full Bridge Converter

### DESCRIPTION

Demonstration circuit 607A is an isolated full bridge converter featuring the [LTC3722](#), [LTC4440](#), [LTC3901](#), and [LT1431](#). This circuit was designed to demonstrate the phase-shifted full bridge power supply to generate 12V at 35A from a typical telecom input voltage range of 36V to 72V. Isolation voltage is 1500VDC. Fixed zero-voltage transition timing was chosen because of the relatively fast

bridge leg transition times with a 48V input. The DC607A PCB layout includes options to implement adaptive timing.

**Design files for this circuit board are available at <http://www.linear.com/demo/DC607A>**

LT, LT, LTC, LTM, Linear Technology and the Linear logo are registered trademarks of Analog Devices, Inc. All other trademarks are the property of their respective owners.

### PERFORMANCE SUMMARY Specifications are at $T_A = 25^\circ\text{C}$

SYMBOL	PARAMETER	CONDITIONS	MIN	TYP	MAX	UNITS
$V_{IN}$	Input Supply Range		36		72	V
$V_{OUT}$	Output Voltage			12.0		V
$I_{OUT}$	Output Current Range	$V_{IN} = 48\text{V}$ , 200LFM	0		35	A
$f_{SW}$	Switching (Clock) Frequency			200		kHz
$V_{OUT(P-P)}$	Output Ripple	$V_{IN} = 48\text{V}$ , $I_{OUT} = 35\text{A}$ (20MHz BW)		140		mV <sub>P-P</sub>
$I_{REG}$	Output Regulation	Line and Load (36V to 72V, 0A to 35A)		$\pm 0.08$		%
$P_{OUT}/P_{IN}$	Efficiency	$V_{IN} = 48\text{V}$ , $I_{OUT} = 35\text{A}$		$>93.9$		%
$P_{OUT}/P_{IN}$	Efficiency	$V_{IN} = 48\text{V}$ , $I_{OUT} = 25\text{A}$		$>94.6$		%
	Isolation	Basic		1500		VDC
	Approximate Size	Component Area $\times$ Top Component Height		$4.3 \times 2.9 \times 0.4$		Inches

### OPERATING PRINCIPLES

The LTC3722 synchronous dual mode phase modulated full bridge controller is used on the primary and works together with the LTC3901 secondary side synchronous driver to provide a synchronous rectified output. When an input voltage is applied, the LTC3722 begins a controlled soft-start of the output voltage. As this voltage begins to rise, the LT1431 programmable reference is quickly powered up via the output voltage. The LT1431 provides feedback via opto-coupler ISO1 to set the output voltage at 12V. The LTC4440 high voltage gate driver is used to level shift the high side primary MOSFETs gate signals.

The LTC3722 provides precise control of gate signals to primary MOSFETs and secondary MOSFETs via T3 and U1 (LTC3901). The LTC3901 includes a timer and current sense to limit reverse inductor current.

For large values of input inductance, a 100V, 47 $\mu\text{F}$  electrolytic capacitor can be added across the input terminals to damp the input filter and provide adequate stability. See Linear Technology Application Note 19 for a discussion on input filter stability analysis. A recommended part is the SUNCON 100ME47AX.

## QUICK START PROCEDURE

Demonstration circuit 607A is easy to set up to evaluate the performance of the LTC3722, LTC4440, LTC3901, and LT1431. Refer to Figure 1 for proper measurement equipment setup and follow the procedure below:

NOTE. When measuring the input or output voltage ripple, care must be taken to avoid a long ground lead on the oscilloscope probe. Measure the output (or input) voltage ripple by touching the probe tip and probe ground directly across the +Vout and –Vout (or +Vin and –Vin) terminals or input/output capacitors. See Figure 2 for proper scope probe technique.

1. Set an input power supply that is capable of 36V to 72V to a voltage of 36V. Then turn off the supply.
2. With power off, connect the supply to the input terminals +Vin and –Vin.
  - a. Input voltages lower than 36V can keep the converter from turning on due to the undervoltage lockout feature of the LTC3722.
  - b. If efficiency measurements are desired, an ammeter capable of measuring 15A<sub>dc</sub> or a resistor shunt can be put in series with the input supply in order to measure the DC607A's input current.
  - c. A voltmeter with a capability of measuring at least 72V can be placed across the input terminals in order to get an accurate input voltage measurement.
3. Turn on the power at the input.

NOTE. Make sure that the input voltage never exceeds 72V.
4. Check for the proper output voltage of 12V ±1%. Turn off the power at the input.
5. Once the proper output voltage is established, connect a variable load capable of sinking 35A at 12V to the output terminals +Vout and –Vout. Set the current for 0A.
  - a. If efficiency measurements are desired, an ammeter or a resistor shunt that is capable of handling 35A<sub>dc</sub> can be put in series with the output load in order to measure the DC607A's output current.
  - b. A voltmeter with a capability of measuring at least 12V can be placed across the output terminals in order to get an accurate output voltage measurement.
6. Turn on the power at the input.

NOTE. If there is no output, temporarily disconnect the load to make sure that the load is not set too high.
7. Once the proper output voltage is again established, adjust the load within the operating range and observe the output voltage regulation, ripple voltage, efficiency and other desired parameters.

**QUICK START PROCEDURE**

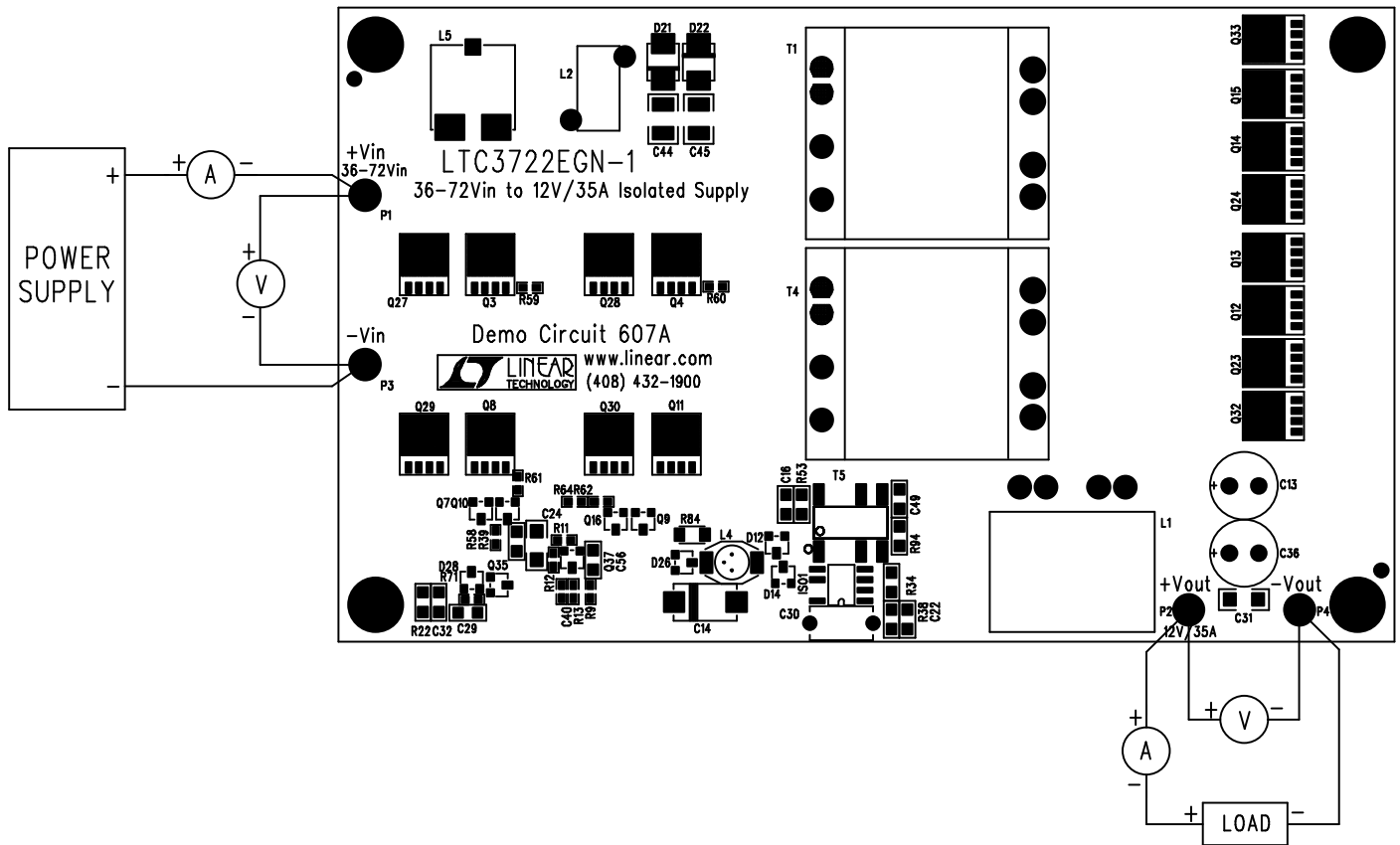

Figure 1. Proper Measurement Equipment Setup

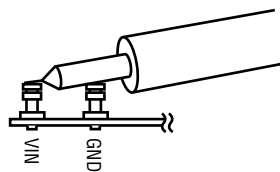

Figure 2. Measuring Input or Output Ripple

## QUICK START PROCEDURE

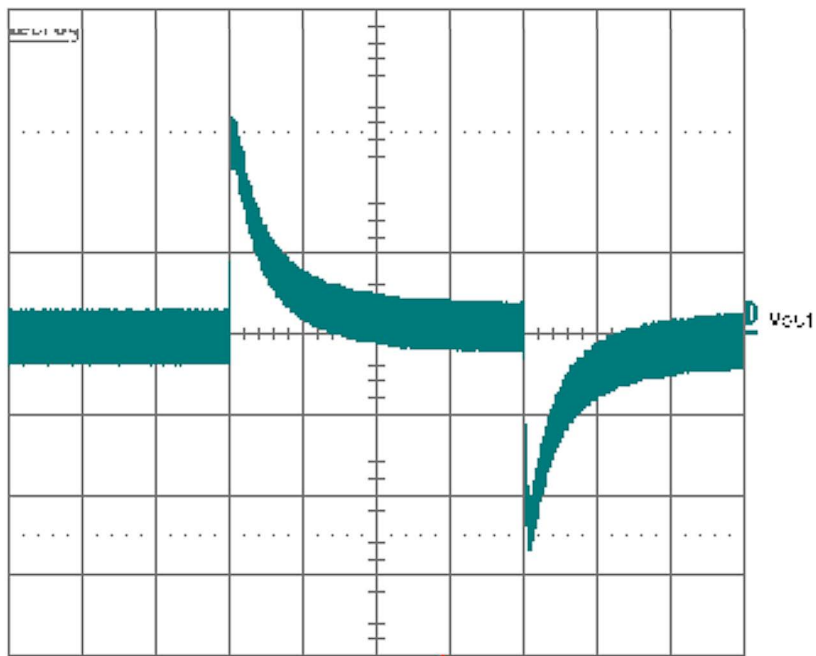

Figure 3. Transient Response, 0A to 35A, 48V<sub>IN</sub> (200mV and 0.5ms/Div)

**QUICK START PROCEDURE**

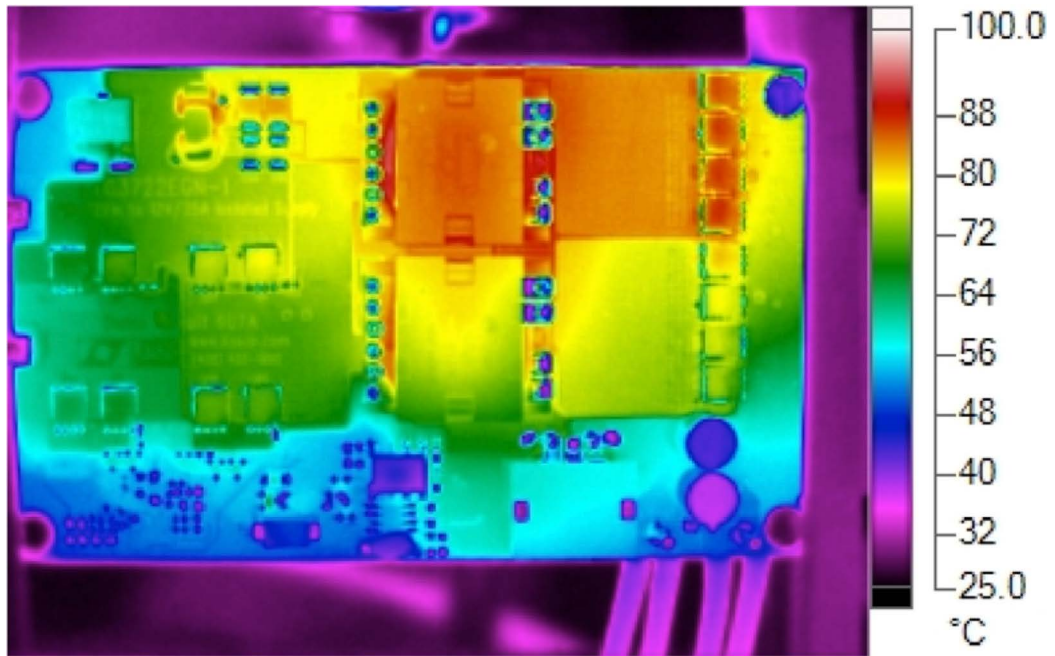

Figure 4. Thermal Map, 48V<sub>IN</sub>, 12V at 35A<sub>OUT</sub>, 200LFM, Frontside

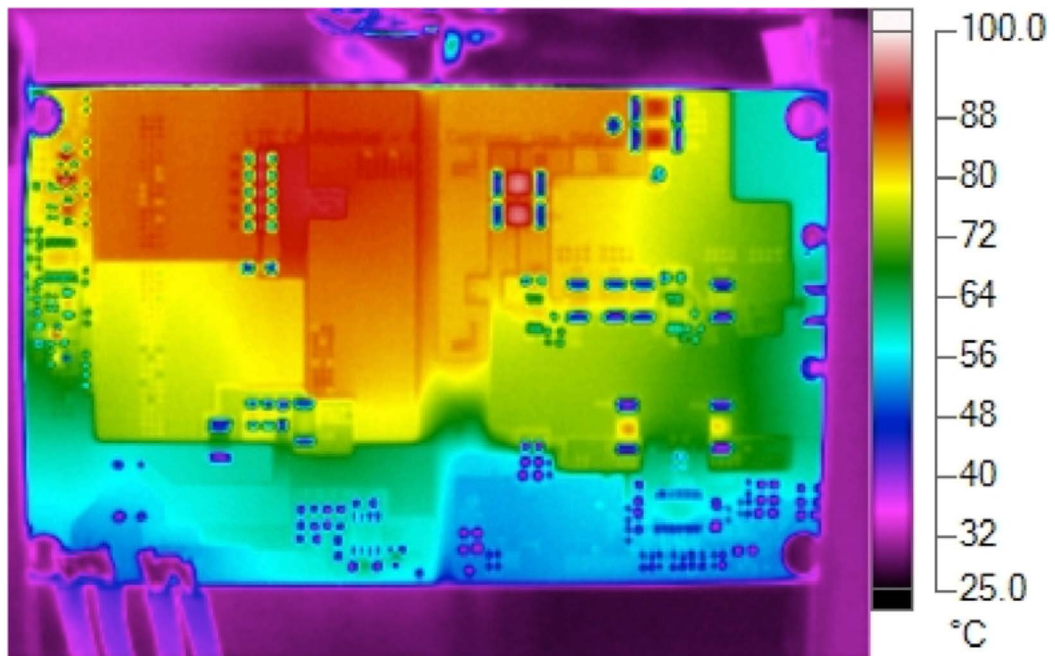

Figure 5. Thermal Map, 48V<sub>IN</sub>, 12V at 35A<sub>OUT</sub>, 200LFM, Backside

**QUICK START PROCEDURE**

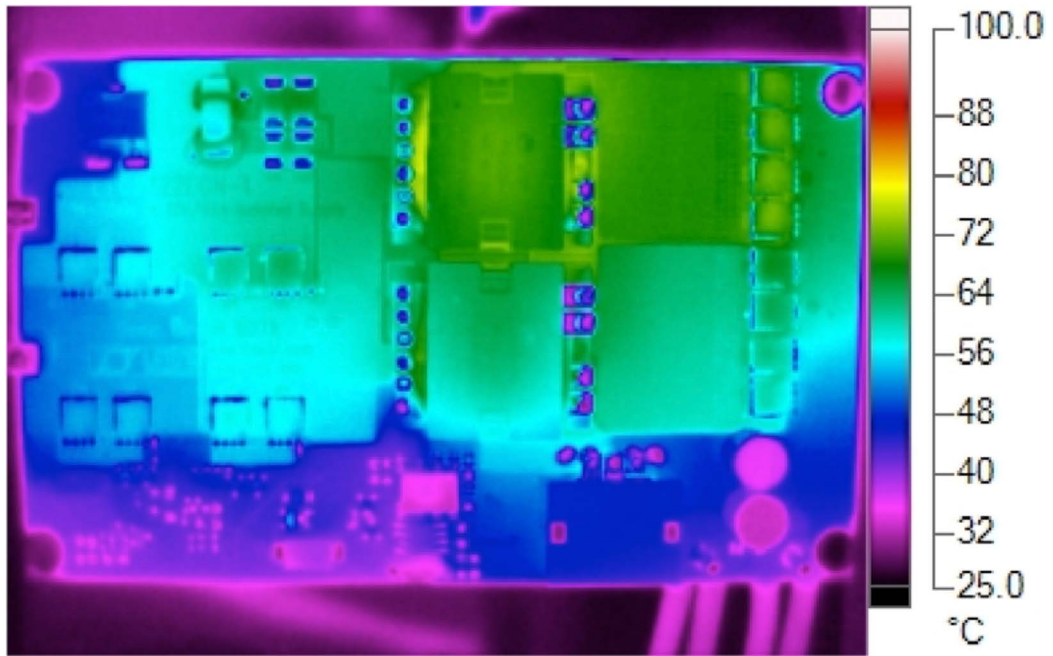

Figure 6. Thermal Map, 48V<sub>IN</sub>, 12V at 35A<sub>OUT</sub>, 400LFM, Frontside

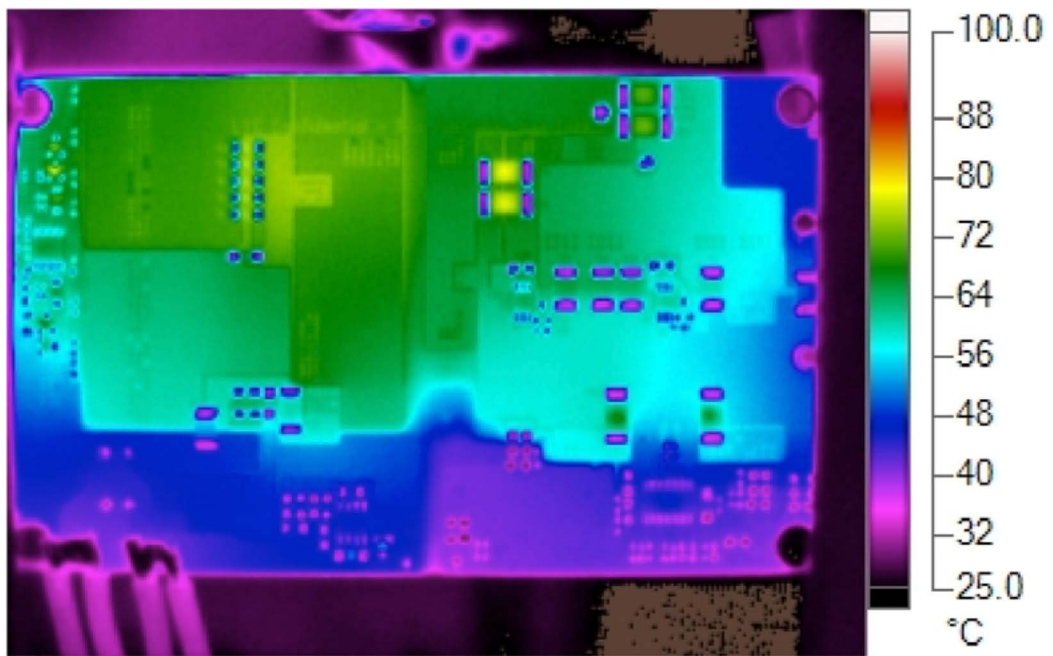

Figure 7. Thermal Map, 48V<sub>IN</sub>, 12V at 35A<sub>OUT</sub>, 400LFM, Backside

## PARTS LIST

ITEM	QTY	REFERENCE	PART DESCRIPTION	MANUFACTURER/PART NUMBER
<b>Required Circuit Components</b>				
1	6	C1, C2, C3, C4, C5, C46	CAP, X7R, 0.82µF, 100V, 10%, 1812	VISHAY, VJ1812Y824KXBAT
2	2	C24, C31	CAP, X7R, 1µF, 25V, 10%, 1206	AVX, 12063C105KAT2A
3	1	C7	CAP, NPO, 470pF, 200V, 10%, 1206	AVX, 12062A471KAT2A
4	1	C16	CAP, X7R, 0.1µF, 25V, 10%, 0805	AVX, 08053C104KAT2A
5	2	C13, C36	CAP, OSCON, 180µF, 16V, 20%,	PANASONIC, 16SEP180M+TSS
6	1	C14	CAP, TANT, 68µF, 20V, 20%, 7343	AVX, TPSE686M020R0150
7	1	C21	CAP, X7R, 0.047µF, 25V, 10%, 0805	AVX, 08053C473KAT2A
8	1	C23	CAP, X7R, 0.022µF, 25V, 10%, 0805	AVX, 08053C223KAT2A
9	1	C26	CAP, X7R, 0.47µF, 25V, 10%, 1206	AVX, 12063C474KAT2A
10	1	C27	CAP, NPO, 330pF, 25V, 10%, 0805	AVX, 08053A331KAT2A
11	1	C28	CAP, NPO, 180pF, 25V, 10%, 0805	AVX, 08053A181KAT2A
12	2	C32, C49	CAP, NPO, 220pF, 25V, 5%, 0805	AVX, 08053A221JAT2A
13	1	C29	CAP, X7R, 0.068µF, 25V, 10%, 0805	AVX, 08053C683KAT2A
14	1	C30	CAP, CER, 2.2nF, 250V, +20,-55%	MURATA, DE2E3KH222MB3BM02F
15	2	C34, C35	CAP, X7R, 0.22µF, 25V, 10% 0805	AVX, 08053C224KAT2A
16	1	C40	CAP, X7R, 2.2nF, 25V, 10%, 0603	AVX, 06033C222KAT2A
17	1	C41	CAP, NPO, 220pF, 25V, 5%, 0603	AVX, 06033A221JAT2A
18	2	C42, C43	CAP, NPO, 22pF, 25V, 10%, 0603	AVX, 06033A220KAT2A
19	2	C44, C45	CAP, X7R, 0.47µF, 100V, 10% 1210	TDK CGA6M2X7R2A474K200AA
20	2	C47, C48	CAP, X5R, 1µF, 25V, 10% 0603	AVX, 06033D105KAT2A
21	1	C50	CAP, NPO 330pF, 25V, 10% 0603	AVX, 06033A331KAT2A
22	2	C58, C59	CAP, X7R 0.1µF, 16V, 10%, 0603	AVX, 0603YC104KAT2A
23	3	D21, D22, D25	SUPER-FAST RECTIFIER, MURS120	DIODES INC, MURS120-13-F
24	4	D12, D14, D23, D24	DIODE, FAST SWITCHING DIODE, SOT23	DIODES INC, BAS21-7-F
25	1	D16	DIODE, 10V, SOT23,	DIODES INC, MMBZ5240B-7-F
26	1	D20	DIODE, 5.1V, SOT23	DIODES INC, MMBZ5231B-7-F
27	1	D26	DIODE, 3.3V, SOT23	DIODES INC, MMBZ5226B-7-F
28	1	D28	DIODE, SCHOTTKY, SOT23	DIODES INC, BAT54-7-F
29	1	ISO1	IC, OPTOISOLATORS, SO8	FAIRCHILD SEMI, MOC207M
30	1	L1	INDUCTOR, 0.85µH,	PULSE, PA1294.910NL
31	1	L2	INDUCTOR, 150nH,	PULSE, PA0651NL
32	1	L4	INDUCTOR, 1mH, DO1608C	COILCRAFT, DO1608C-105MLB
33	1	L5	INDUCTOR, 1.3µH, CDEP105	SUMIDA, CDEP105-1R3MC-50
34	4	Q7, Q9, Q25, Q26	XSTR, NPN, SOT23	DIODE INC, FMMT619TA
35	16	Q3, Q4, Q8, Q11 TO Q15, Q23, Q24, Q27 TO Q30, Q32, Q33	N-MOSFET, 80V, PowerPak-SO-8	INFINEON, BSC072N08NS5ATMA1
36	4	Q10, Q16 TO Q18	XSTR, PNP, SOT23	DIODE INC., FMMT718TA
37	2	Q34, Q35	XSTR, NPN, SOT23	DIODE INC., MMBT3904-7-F
38	2	R2, R5	RES, 3.9k, 1/4W, 5%, 1206	VISHAY, CRCW12063K90JNEA
39	5	R1, R4, R6, R8, R10	RES, 240, 1/4W, 5%, 1206	YAGEO, RC1206JR-07240RL

# DEMO MANUAL DC607A

## PARTS LIST

ITEM	QTY	REFERENCE	PART DESCRIPTION	MANUFACTURER/PART NUMBER
40	2	R3, R91	RES, 1k, 1/16W, 5%, 0603	VISHAY, CRCW06031K00JNEA
41	1	R18	RES, 182k, 1/8W, 1%, 0805	VISHAY, CRCW0805182KFKEA
42	1	R22	RES, 30.1k, 1/8W, 1%, 0805	VISHAY, CRCW080530K1FKEA
43	1	R30	RES, 20k, 1/8W, 5%, 0805	VISHAY, CRCW080520K0JNEA
44	2	R32, R33	RES, 4.99k, 1/16W, 1%, 0603	VISHAY, CRCW06034K99FKEA
45	1	R37	RES, 470, 1/8W, 5%, 1206	VISHAY, CRCW1206470RJNEA
46	1	R38	RES, 330, 1/8W, 5%, 0805	VISHAY, CRCW0805330RJNEA
47	1	R39	RES, 150, 1/16W, 5%, 0805	VISHAY, CRCW0805150RJNEA
48	1	R40	RES, 2.7k, 1/16W, 5%, 0805	VISHAY, CRCW08052K70JNEA
49	1	R41	RES, 10k, 1/8W, 5%, 0805	VISHAY, CRCW080510K0JNEA
50	1	R42	RES, 9.53k, 1/8W, 1%, 0805	VISHAY, CRCW08059K53FKEA
51	1	R43	RES, 750, 1/8W, 5%, 0603	VISHAY, CRCW0603750RJNEA
52	1	R44	RES, 5.1k, 1/16W, 5%, 0603	VISHAY, CRCW06035K10JNEA
53	1	R46	RES, 2.49k, 1/8W, 1%, 0805	VISHAY, CRCW08052K49FKEA
54	1	R47	RES, 33k, 1/16W, 5%, 0603	VISHAY, CRCW060333K0JNEA
55	2	R48, R49	RES, 0.020, 2W, 1%, 2512	STACKPOLE ELE. CSRN2512FK20L0
56	1	R53	RES, 22, 1/8W, 5%, 0805	VISHAY, CRCW080522R0JNEA
57	1	R58	RES, 10k, 1/16W, 5%, 0603	VISHAY, CRCW060310K0JNEA
58	2	R54, R55	RES, 80.6k, 1/16W, 1%, 0603	VISHAY, CRCW060380K6FKEA
59	1	R56	RES, 20k, 1/16W, 1%, 0603	VISHAY, CRCW060320K0FKEA
60	1	R71	RES, 8.25k, 1/16W, 1%, 0603	VISHAY, CRCW06038K25FKEA
61	4	R72 TO R75	RES, 100, 1W, 5%, 2512	VISHAY, CRCW2512100RJNEA
62	1	R84	RES, 100, 1/4W, 5%, 1206	VISHAY, CRCW1206100RJNEG
63	2	R85, R88	RES, 4.87k, 1/4W, 1%, 1206	VISHAY, CRCW12064K87FKEA
64	2	R86, R89	RES, 9.09k, 1/16W, 1%, 0603	VISHAY, CRCW06039K09FKEA
65	2	R87, R90	RES, 3.16k, 1/16W, 1%, 0603	VISHAY, CRCW06033K16FKEA
66	1	R92	RES, 39.2k, 1/16W, 1%, 0603	VISHAY, CRCW060339K2FKEA
67	2	R65, R66	RES, 18.2k 1/16W, 1%, 0603	VISHAY, CRCW060318K2FKEA
68	1	R15	RES, 1M, 1/16W, 5%, 0603	VISHAY, CRCW06031M00JNEA
69	1	R93	RES, 100Ω 1/16W, 5%, 0603	VISHAY, CRCW0603100RJNEA
70	1	R94	RES, 100Ω 1/16W, 1%, 0805	VISHAY, CRCW0805100RFKEA
71	1	R95	RES, 200k, 1/16W, 5%, 0603	VISHAY, CRCW0603200KJNEA
72	2	T1, T4	TRANSFORMER	PULSE, PA0526NL
73	1	T5	TRANSFORMER	PULSE, PA0297NL
74	1	U1	IC, LTC3901EGN SSOP-16	LINEAR, LTC3901EGN#PBF
75	1	U2	IC, LTC3722EGN-1, SSOP-24GN	LINEAR, LTC3722EGN-1#PBF
76	1	U3	IC, LT1431CS8, SO8	LINEAR, LT1431CS8#PBF
77	2	U5, U6	IC, LTC4440EMS8E,MSOP-8/Exposed	LINEAR, LTC4440EMS8E#PBF



## PARTS LIST

ITEM	QTY	REFERENCE	PART DESCRIPTION	MANUFACTURER/PART NUMBER
<b>Additional Demo Board Circuit Components</b>				
1	0	C19, C20, C22, C53, C56, C57	CAP, OPT, 0805	OPT
2	0	Q37 (OPT)	XSTR, PNP, SOT23	OPT
3	0	R7 (OPT)	RES, OPT, 1206	OPT
4	0	R9, R11, R12, R14, R31, R61, R62	RES, OPT, 0603	OPT
5	15	R13, R57, R59, R60, R63, R64, R76 TO R83, R98	RES, 0 JUMPER, 0603	VISHAY, CRCW06030000Z0EA
6	0	R23 TO R28, R34 (OPT)	RES, OPT, 0805	OPT
7	1	R45	RES, 0 JUMPER, 0805	VISHAY, CRCW08050000Z0EA
8	2	R50, R51	RES, 33, 1/8W, 5%, 0805	VISHAY, CRCW080533R0JNEA
<b>Hardware: For Demo Board Only</b>				
1	4	P1, P2, P3, P4	MICRO PINS, 0.08 PIN-SWAGE MOUNT	KEYSTONE, 1455-2
2	4	STANDOFF	STANDOFF, NYLON 0.50" TALL.HOLE 0.125	WURTH ELEKTRONIK, 702935000
3	1		PRINTED CIRCUIT BOARD	DEMO CIRCUIT #607A

## SCHEMATIC DIAGRAM

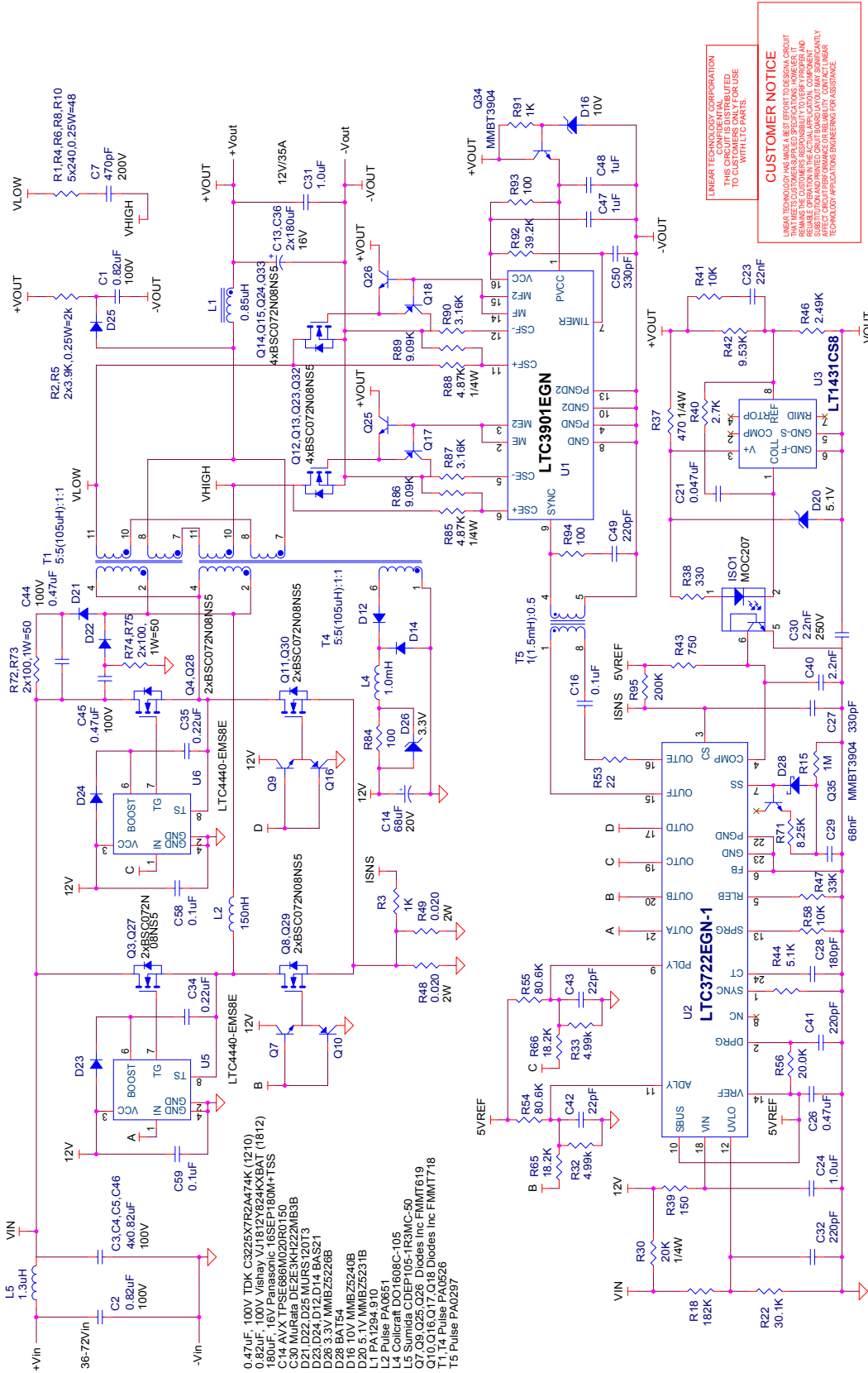

Figure 8. Schematic without Optional Components



# DEMO MANUAL DC607A

---

## DEMONSTRATION BOARD IMPORTANT NOTICE

Linear Technology Corporation (LTC) provides the enclosed product(s) under the following **AS IS** conditions:

This demonstration board (DEMO BOARD) kit being sold or provided by Linear Technology is intended for use for **ENGINEERING DEVELOPMENT OR EVALUATION PURPOSES ONLY** and is not provided by LTC for commercial use. As such, the DEMO BOARD herein may not be complete in terms of required design-, marketing-, and/or manufacturing-related protective considerations, including but not limited to product safety measures typically found in finished commercial goods. As a prototype, this product does not fall within the scope of the European Union directive on electromagnetic compatibility and therefore may or may not meet the technical requirements of the directive, or other regulations.

If this evaluation kit does not meet the specifications recited in the DEMO BOARD manual the kit may be returned within 30 days from the date of delivery for a full refund. **THE FOREGOING WARRANTY IS THE EXCLUSIVE WARRANTY MADE BY THE SELLER TO BUYER AND IS IN LIEU OF ALL OTHER WARRANTIES, EXPRESSED, IMPLIED, OR STATUTORY, INCLUDING ANY WARRANTY OF MERCHANTABILITY OR FITNESS FOR ANY PARTICULAR PURPOSE. EXCEPT TO THE EXTENT OF THIS INDEMNITY, NEITHER PARTY SHALL BE LIABLE TO THE OTHER FOR ANY INDIRECT, SPECIAL, INCIDENTAL, OR CONSEQUENTIAL DAMAGES.**

The user assumes all responsibility and liability for proper and safe handling of the goods. Further, the user releases LTC from all claims arising from the handling or use of the goods. Due to the open construction of the product, it is the user's responsibility to take any and all appropriate precautions with regard to electrostatic discharge. Also be aware that the products herein may not be regulatory compliant or agency certified (FCC, UL, CE, etc.).

No License is granted under any patent right or other intellectual property whatsoever. **LTC assumes no liability for applications assistance, customer product design, software performance, or infringement of patents or any other intellectual property rights of any kind.**

LTC currently services a variety of customers for products around the world, and therefore this transaction **is not exclusive**.

**Please read the DEMO BOARD manual prior to handling the product.** Persons handling this product must have electronics training and observe good laboratory practice standards. **Common sense is encouraged.**

This notice contains important safety information about temperatures and voltages. For further safety concerns, please contact a LTC application engineer.

Mailing Address:

Linear Technology  
1630 McCarthy Blvd.  
Milpitas, CA 95035

Copyright © 2004, Linear Technology Corporation