

4

3

2

1

THIS DRAWING IS UNPUBLISHED. RELEASED FOR PUBLICATION 20
© COPYRIGHT 20 ALL RIGHTS RESERVED.

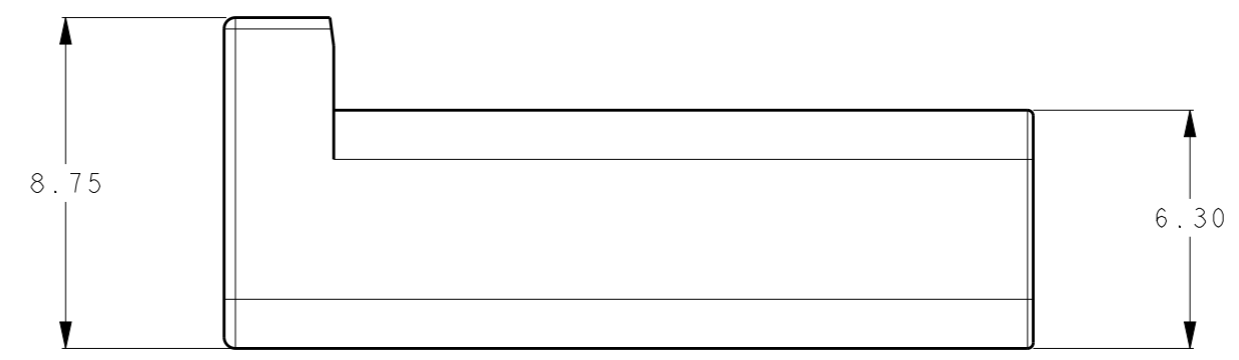
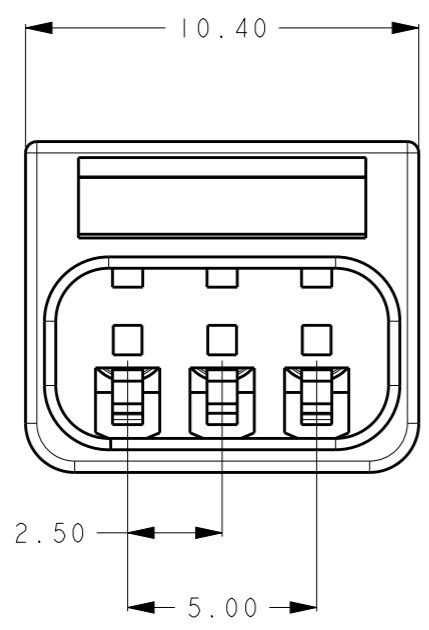
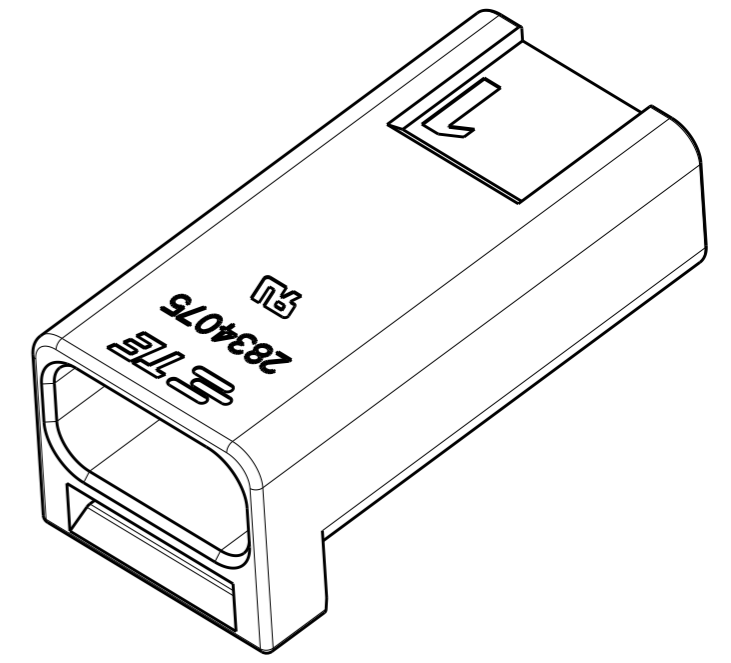
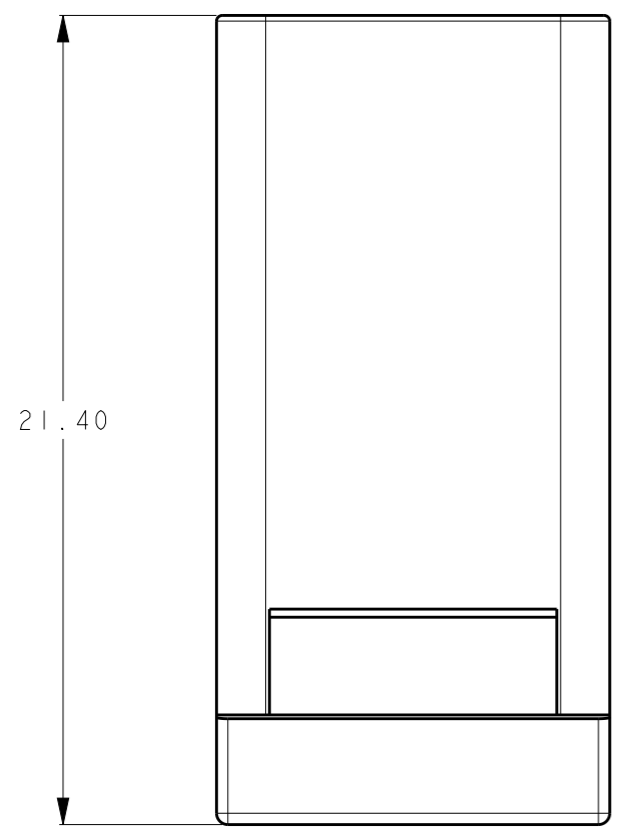

ES

REVISIONS					
P	LTR	DESCRIPTION	DATE	DWN	APVD
	A	INITIAL RELEASE	25JUL2016	Z.W	X.X



GRAY	3	4-2834075-3
RED	3	3-2834075-3
BLACK	3	2-2834075-3
WHITE	3	1-2834075-3
GRAY	2	4-2834075-2
RED	2	3-2834075-2
BLACK	2	2-2834075-2
WHITE	2	1-2834075-2
COLOR	NO OF POSN	PART NUMBER

NOTES:
 1. MATERIAL:
 HOUSING: PBT, FI PER UL746C
 SEAL: SILICONE RUBBER.
 2. PN: SEE TABLE
 3. PACKAGING: TRAY.
 4. PACKAGING SPEC: 107-137093.

THIS DRAWING IS A CONTROLLED DOCUMENT.		DWN 15JULY2016 ZHANG WEI	 TE Connectivity	
DIMENSIONS: mm		CHK 15JULY2016 SHI MING		
TOLERANCES UNLESS OTHERWISE SPECIFIED: ± 0.5		APVD 15JULY2016 XU XIANG	NAME RECEPTACLE MINIATURE WATERPROOF CONN.	
0 PLC ± 1 PLC ± 2 PLC ± 3 PLC ± 4 PLC ± ANGLES ±5°		PRODUCT SPEC 108-137093	SIZE CAGE CODE DRAWING NO RESTRICTED TO	
MATERIAL		APPLICATION SPEC 114-137093	A300779C-2834075	
FINISH		WEIGHT -	SCALE 5:1 SHEET 1 OF 2 REV A	
		CUSTOMER DRAWING		

REVISIONS

P	LTR	DESCRIPTION	DATE	DWN	APVD
		SEE SHEET 1			

- NOTE:
 1.PUT PARTS IN THE TRAY.
 2.PUT PACKED TRAYS INTO CARTON.
 3.SEAL THE CARTON
 4.PACKAGING QUANTITY: SEE TABLE.
 5.PACKAGING SPEC : 107-137093.

PART NUMBER	PARTS PER TRAY	TRAYS PER CARTON	PARTS PER CARTON
1-2834075-2	270 PCS	22	5760 PCS
2-2834075-2	270 PCS	22	5760 PCS
3-2834075-2	270 PCS	22	5760 PCS
4-2834075-2	270 PCS	22	5760 PCS
1-2834075-3	270 PCS	22	5760 PCS
2-2834075-3	270 PCS	22	5760 PCS
3-2834075-3	270 PCS	22	5760 PCS
4-2834075-3	270 PCS	22	5760 PCS

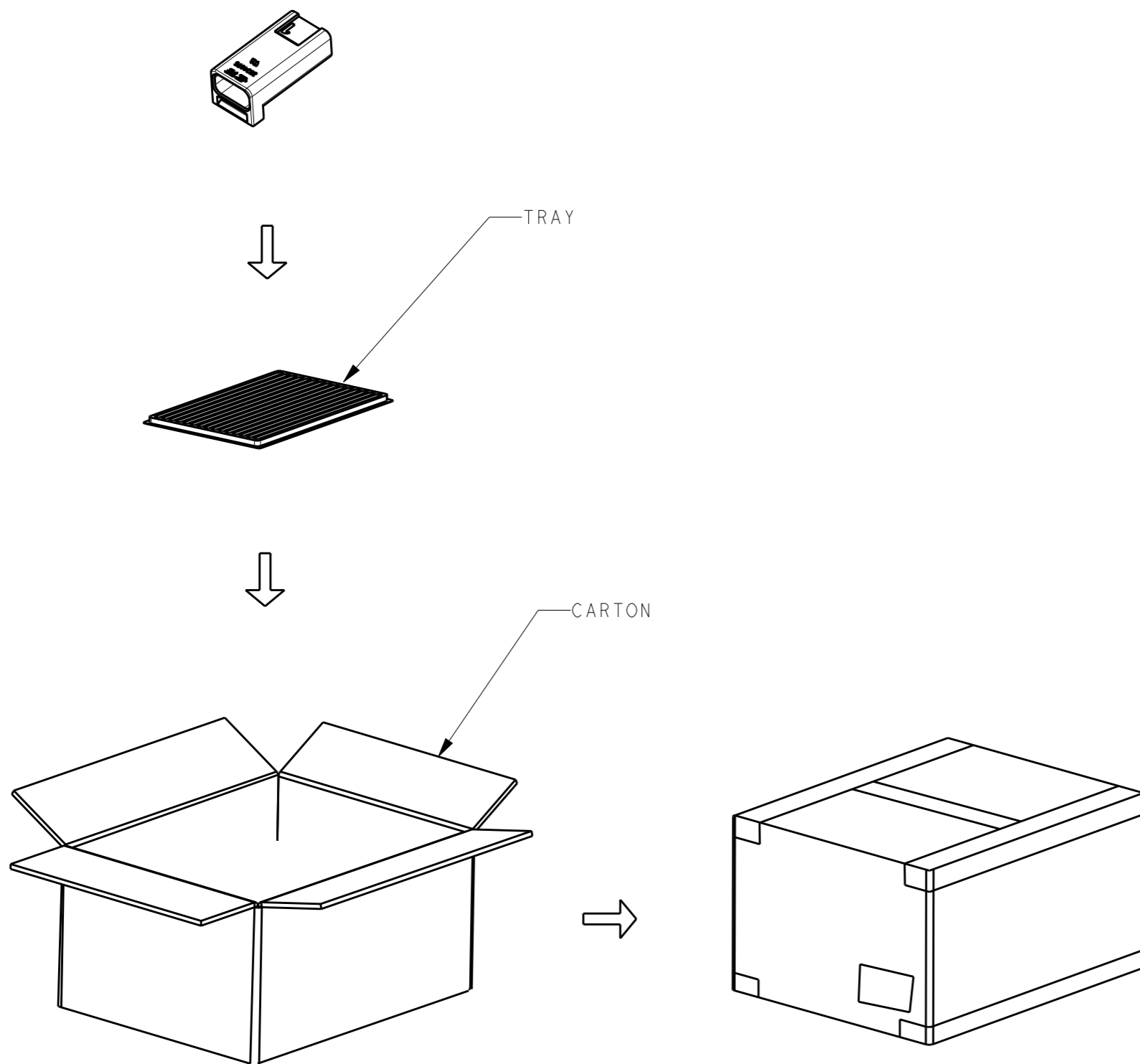

THIS DRAWING IS A CONTROLLED DOCUMENT.		DWN	15 JULY 2016	STE TE Connectivity
		CHK	15 JULY 2016	
		APVD	15 JULY 2016	
DIMENSIONS: mm		TOLERANCES UNLESS OTHERWISE SPECIFIED: ± 0.5		NAME
		0 PLC ±		RECEPTACLE MINIATURE WATERPROOF CONNECTOR
		1 PLC ±		SIZE
		2 PLC ±		CAGE CODE
		3 PLC ±		DRAWING NO
		4 PLC ±		RESTRICTED TO
		ANGLES ± 5°		A300779
MATERIAL		FINISH		©-2834074
				SCALE 5:1
		WEIGHT		SHEET 2 OF 2
		CUSTOMER DRAWING		REV A