

### Application

- Brushed Motor drive applications
- BLDC Motor drive applications
- Battery powered circuits
- Half-bridge and full-bridge topologies
- Synchronous rectifier applications
- Resonant mode power supplies
- OR-ing and redundant power switches
- DC/DC and AC/DC converters
- DC/AC Inverters

### Benefits

- Improved Gate, Avalanche and Dynamic dV/dt Ruggedness
- Fully Characterized Capacitance and Avalanche SOA
- Enhanced body diode dV/dt and dI/dt Capability
- Lead-Free, RoHS Compliant

HEXFET® Power MOSFET

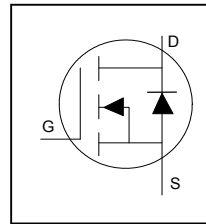

<b>V<sub>DSS</sub></b>	<b>60V</b>
<b>R<sub>DS(on)</sub> typ.</b>	<b>2.75mΩ</b>
	<b>3.30mΩ</b>
<b>I<sub>D</sub></b>	<b>173A</b>

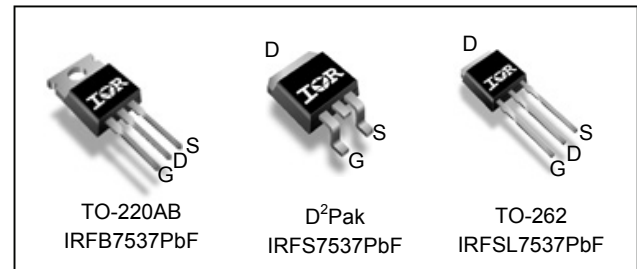

<b>G</b>	<b>D</b>	<b>S</b>
Gate	Drain	Source

Base part number	Package Type	Standard Pack		Orderable Part Number
		Form	Quantity	
IRFB7537PbF	TO-220	Tube	50	IRFB7537PbF
IRFSL7537PbF	TO-262	Tube	50	IRFSL7537PbF
IRFS7537PbF	D²-Pak	Tube	50	IRFS7537PbF
		Tape and Reel Left	800	IRFS7537TRLpBF

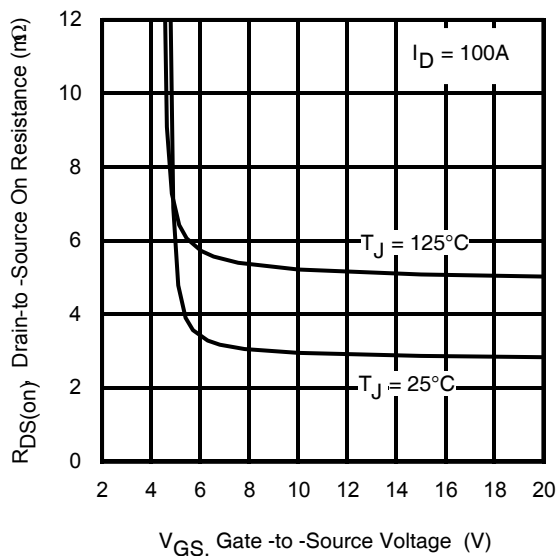

**Fig 1.** Typical On-Resistance vs. Gate Voltage

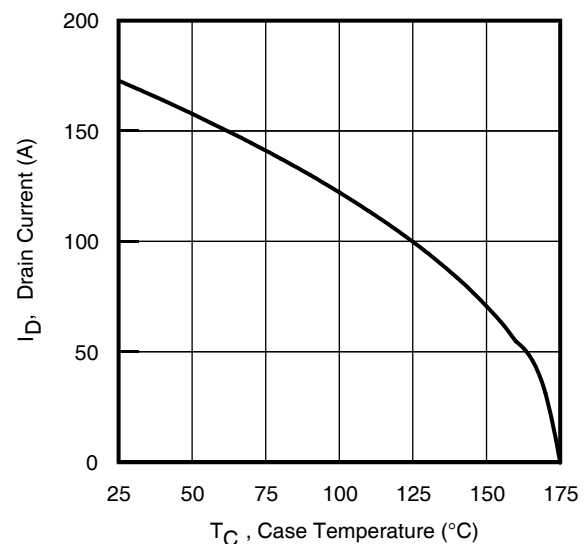

**Fig 2.** Maximum Drain Current vs. Case Temperature

**Absolute Maximum Rating**

Symbol	Parameter	Max.	Units
$I_D @ T_C = 25^\circ\text{C}$	Continuous Drain Current, $V_{GS} @ 10\text{V}$	173	A
$I_D @ T_C = 100^\circ\text{C}$	Continuous Drain Current, $V_{GS} @ 10\text{V}$	122	
$I_{DM}$	Pulsed Drain Current ①	700	
$P_D @ T_C = 25^\circ\text{C}$	Maximum Power Dissipation	230	W
	Linear Derating Factor	1.5	W/°C
$V_{GS}$	Gate-to-Source Voltage	$\pm 20$	V
$T_J$ $T_{STG}$	Operating Junction and Storage Temperature Range	-55 to + 175	°C
	Soldering Temperature, for 10 seconds (1.6mm from case)	300	
	Mounting Torque, 6-32 or M3 Screw	10 lbf-in (1.1 N-m)	

**Avalanche Characteristics**

$E_{AS}$	Single Pulse Avalanche Energy ②	270	mJ
$E_{AS(L=1mH)}$	Single Pulse Avalanche Energy ③	554	
$I_{AR}$	Avalanche Current ①	See Fig 15, 16, 23a, 23b	A
$E_{AR}$	Repetitive Avalanche Energy ①		mJ

**Thermal Resistance**

Symbol	Parameter	Typ.	Max.	Units
$R_{\theta JC}$	Junction-to-Case ⑦	—	0.65	°C/W
$R_{\theta CS}$	Case-to-Sink, Flat Greased Surface	0.50	—	
$R_{\theta JA}$	Junction-to-Ambient (TO-220)	—	62	
$R_{\theta JA}$	Junction-to-Ambient (PCB Mount) (D <sup>2</sup> -Pak)⑧	—	40	

**Static @  $T_J = 25^\circ\text{C}$  (unless otherwise specified)**

Symbol	Parameter	Min.	Typ.	Max.	Units	Conditions
$V_{(BR)DSS}$	Drain-to-Source Breakdown Voltage	60	—	—	V	$V_{GS} = 0\text{V}, I_D = 250\mu\text{A}$
$\Delta V_{(BR)DSS}/\Delta T_J$	Breakdown Voltage Temp. Coefficient	—	40	—	mV/°C	Reference to 25°C, $I_D = 1\text{mA}$ ①
$R_{DS(on)}$	Static Drain-to-Source On-Resistance	—	2.75	3.30	mΩ	$V_{GS} = 10\text{V}, I_D = 100\text{A}$
		—	3.50	—		$V_{GS} = 6.0\text{V}, I_D = 50\text{A}$
$V_{GS(th)}$	Gate Threshold Voltage	2.1	—	3.7	V	$V_{DS} = V_{GS}, I_D = 150\mu\text{A}$
$I_{DSS}$	Drain-to-Source Leakage Current	—	—	1.0	μA	$V_{DS} = 60\text{V}, V_{GS} = 0\text{V}$
		—	—	150		$V_{DS} = 60\text{V}, V_{GS} = 0\text{V}, T_J = 125^\circ\text{C}$
$I_{GSS}$	Gate-to-Source Forward Leakage	—	—	100	nA	$V_{GS} = 20\text{V}$
	Gate-to-Source Reverse Leakage	—	—	-100		$V_{GS} = -20\text{V}$
$R_G$	Gate Resistance	—	2.0	—	Ω	

**Notes:**

- ① Repetitive rating; pulse width limited by max. junction temperature.
- ② Limited by  $T_{Jmax}$ , starting  $T_J = 25^\circ\text{C}$ ,  $L = 54\mu\text{H}$ ,  $R_G = 50\Omega$ ,  $I_{AS} = 100\text{A}$ ,  $V_{GS} = 10\text{V}$ .
- ③  $I_{SD} \leq 100\text{A}$ ,  $di/dt \leq 1130\text{A}/\mu\text{s}$ ,  $V_{DD} \leq V_{(BR)DSS}$ ,  $T_J \leq 175^\circ\text{C}$ .
- ④ Pulse width  $\leq 400\mu\text{s}$ ; duty cycle  $\leq 2\%$ .
- ⑤  $C_{oss}$  eff. (TR) is a fixed capacitance that gives the same charging time as  $C_{oss}$  while  $V_{DS}$  is rising from 0 to 80%  $V_{DSS}$ .
- ⑥  $C_{oss}$  eff. (ER) is a fixed capacitance that gives the same energy as  $C_{oss}$  while  $V_{DS}$  is rising from 0 to 80%  $V_{DSS}$ .
- ⑦  $R_\theta$  is measured at  $T_J$  approximately 90°C.
- ⑧ When mounted on 1" square PCB (FR-4 or G-10 Material). For recommended footprint and soldering techniques refer to application note #AN-994.: <http://www.irf.com/technical-info/appnotes/an-994.pdf>
- ⑨ Limited by  $T_{Jmax}$ , starting  $T_J = 25^\circ\text{C}$ ,  $L = 1\text{mH}$ ,  $R_G = 50\Omega$ ,  $I_{AS} = 33\text{A}$ ,  $V_{GS} = 10\text{V}$ .

**Dynamic Electrical Characteristics @  $T_J = 25^\circ\text{C}$  (unless otherwise specified)**

Symbol	Parameter	Min.	Typ.	Max.	Units	Conditions
gfs	Forward Transconductance	190	—	—	S	$V_{DS} = 10\text{V}, I_D = 100\text{A}$
$Q_g$	Total Gate Charge	—	142	210	nC	$I_D = 100\text{A}$ $V_{DS} = 30\text{V}$ $V_{GS} = 10\text{V}$
$Q_{gs}$	Gate-to-Source Charge	—	36	—		
$Q_{gd}$	Gate-to-Drain Charge	—	43	—		
$Q_{sync}$	Total Gate Charge Sync. ( $Q_g - Q_{gd}$ )	—	99	—		
$t_{d(on)}$	Turn-On Delay Time	—	15	—	ns	$V_{DD} = 30\text{V}$ $I_D = 100\text{A}$ $R_G = 2.7\Omega$ $V_{GS} = 10\text{V}^{(4)}$
$t_r$	Rise Time	—	105	—		
$t_{d(off)}$	Turn-Off Delay Time	—	82	—		
$t_f$	Fall Time	—	84	—		
$C_{iss}$	Input Capacitance	—	7020	—	pF	$V_{GS} = 0\text{V}$ $V_{DS} = 25\text{V}$ $f = 1.0\text{MHz}$ , See Fig.7
$C_{oss}$	Output Capacitance	—	640	—		
$C_{riss}$	Reverse Transfer Capacitance	—	395	—		
$C_{oss\ eff.(ER)}$	Effective Output Capacitance (Energy Related)	—	665	—		
$C_{oss\ eff.(TR)}$	Output Capacitance (Time Related)	—	880	—		

**Diode Characteristics**

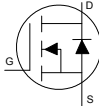
Symbol	Parameter	Min.	Typ.	Max.	Units	Conditions
$I_S$	Continuous Source Current (Body Diode)	—	—	173	A	MOSFET symbol showing the integral reverse p-n junction diode. 
$I_{SM}$	Pulsed Source Current (Body Diode) ①	—	—	700		
$V_{SD}$	Diode Forward Voltage	—	—	1.2	V	$T_J = 25^\circ\text{C}, I_S = 100\text{A}, V_{GS} = 0\text{V}$ ④
dv/dt	Peak Diode Recovery dv/dt ③	—	10	—	V/ns	$T_J = 175^\circ\text{C}, I_S = 100\text{A}, V_{DS} = 60\text{V}$
$t_{rr}$	Reverse Recovery Time	—	39	—	ns	$T_J = 25^\circ\text{C}$ $V_{DD} = 51\text{V}$ $T_J = 125^\circ\text{C}$ $I_F = 100\text{A}$ ,
		—	41	—		
$Q_{rr}$	Reverse Recovery Charge	—	46	—	nC	$T_J = 25^\circ\text{C}$ $di/dt = 100\text{A}/\mu\text{s}$ ④ $T_J = 125^\circ\text{C}$
		—	56	—		
$I_{RRM}$	Reverse Recovery Current	—	2.1	—	A	$T_J = 25^\circ\text{C}$

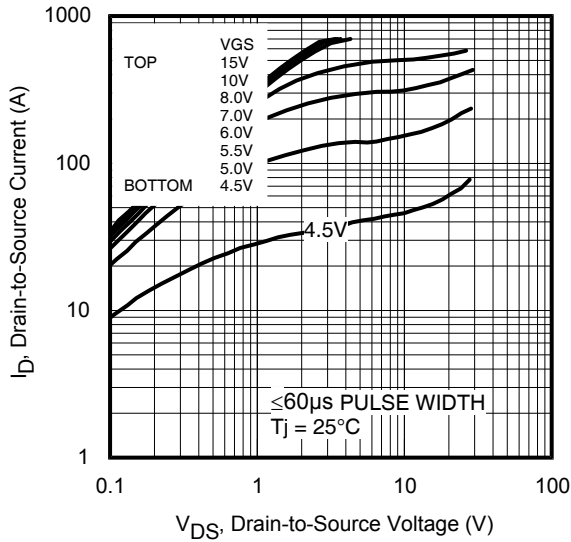
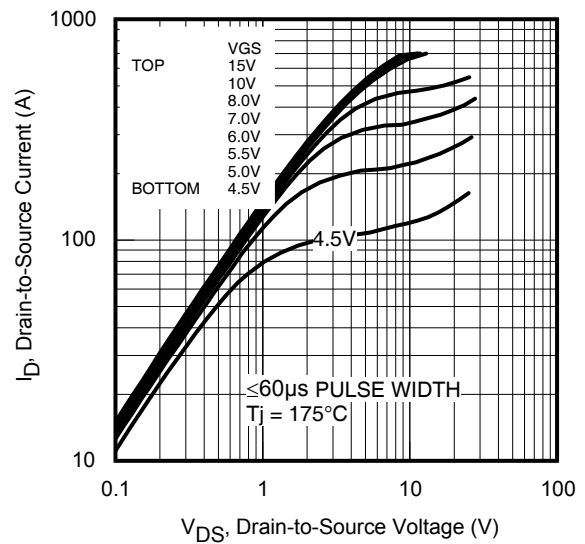
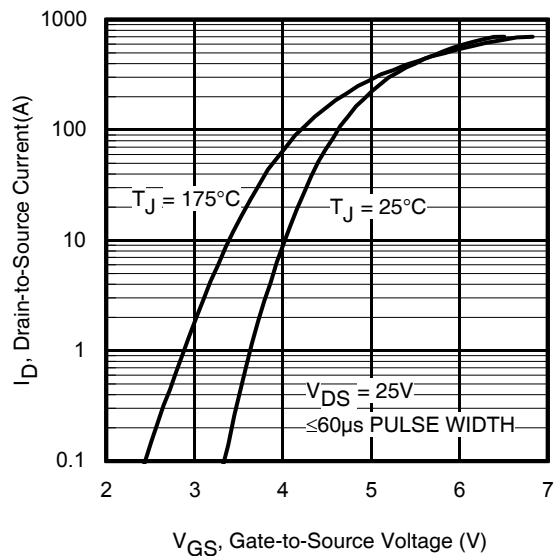
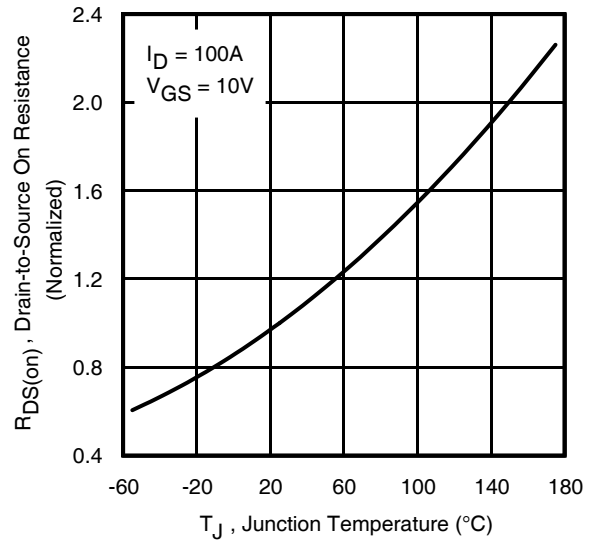
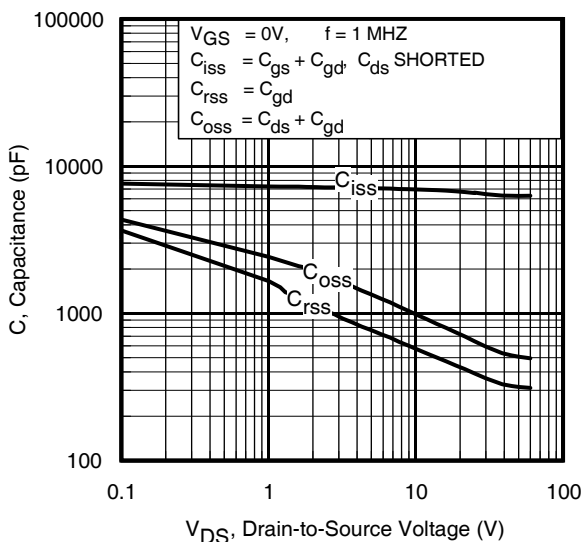
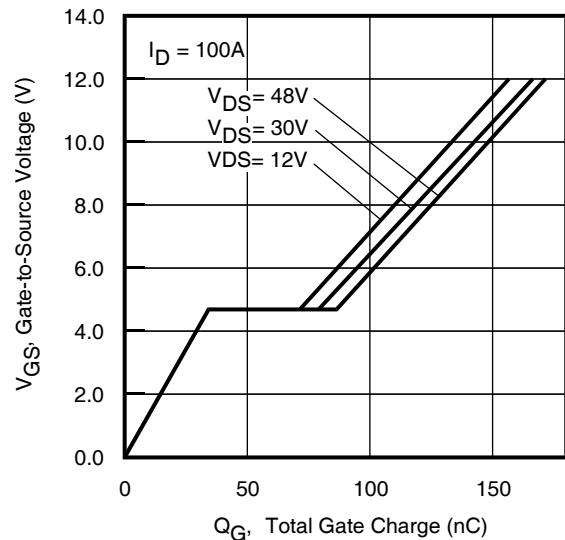
**Fig 3. Typical Output Characteristics**

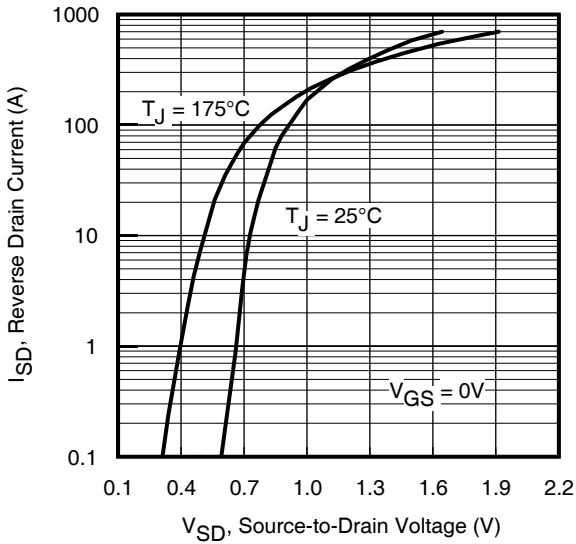
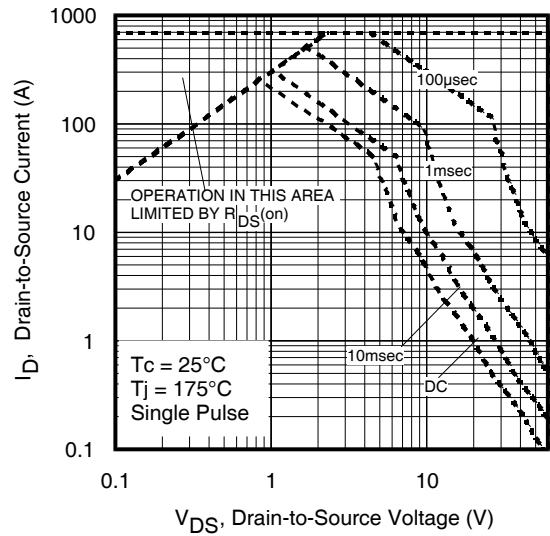
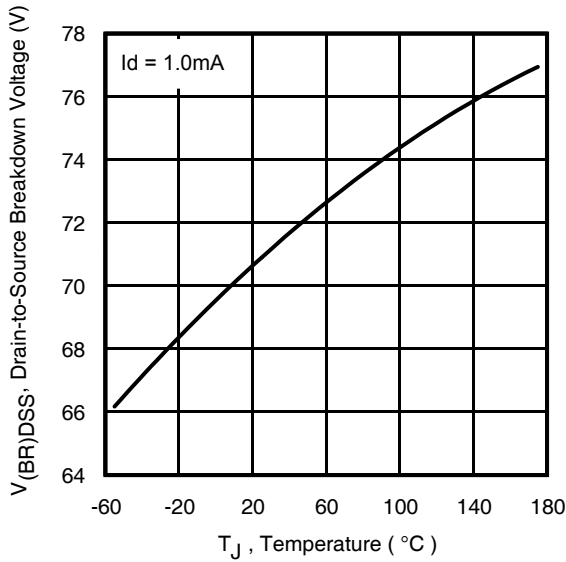
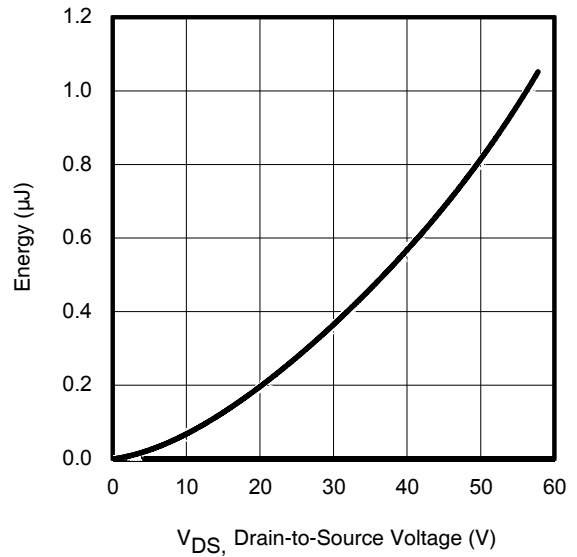
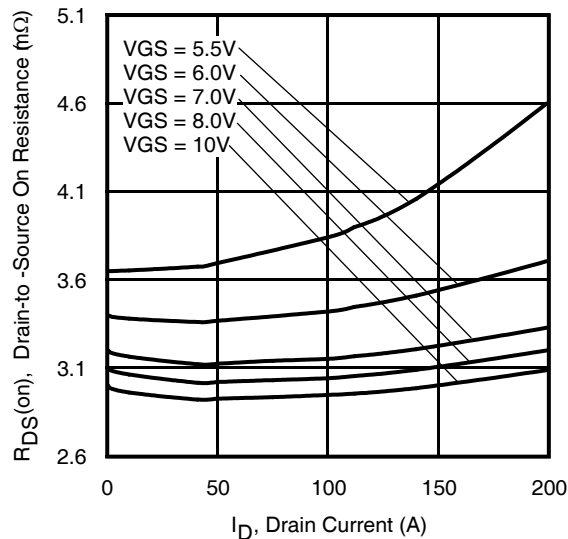
**Fig 4. Typical Output Characteristics**

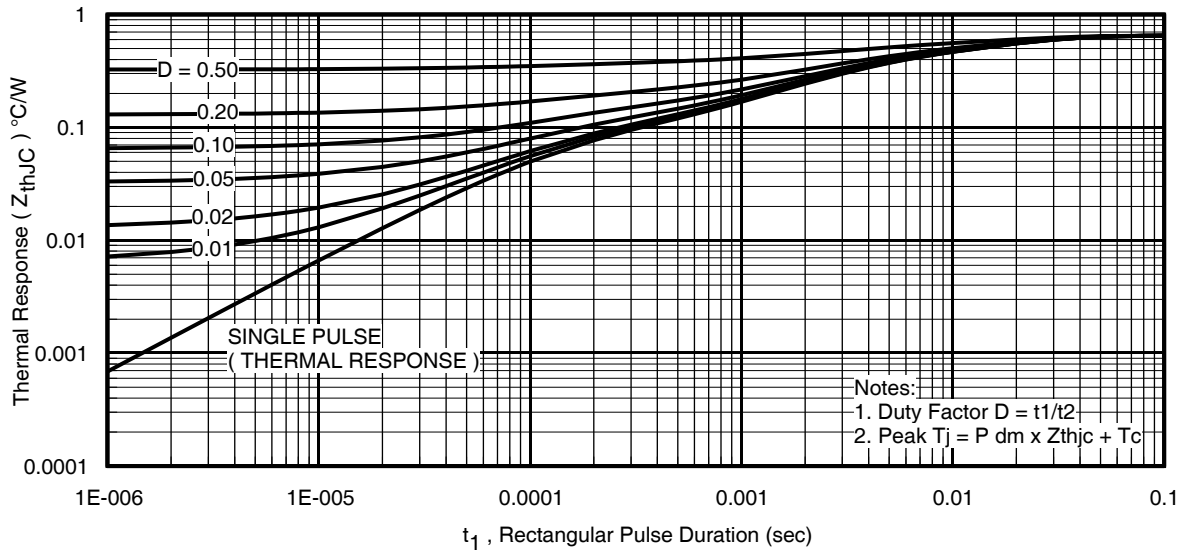
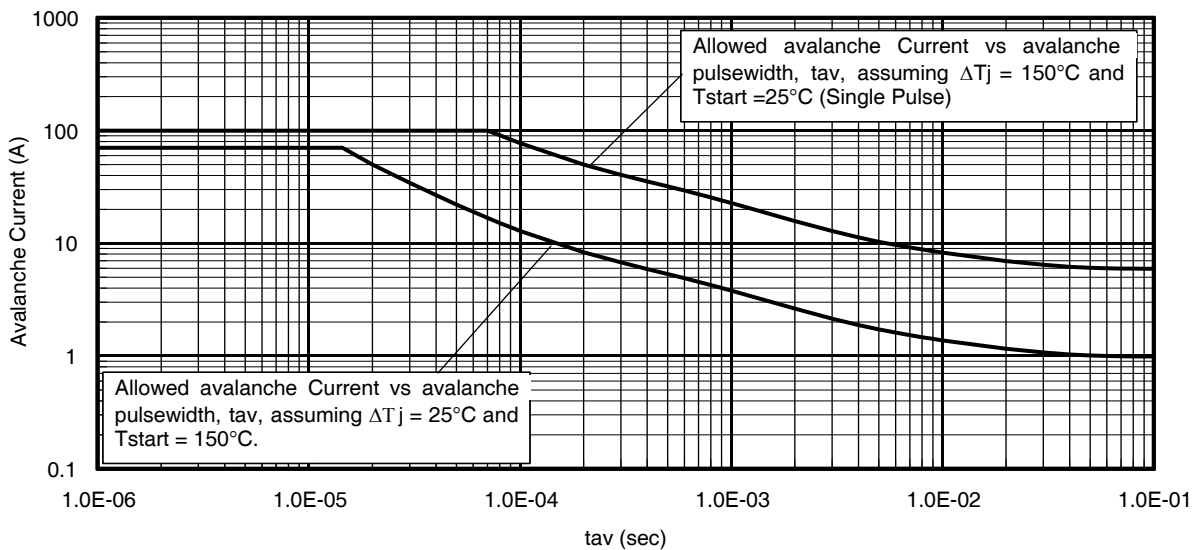
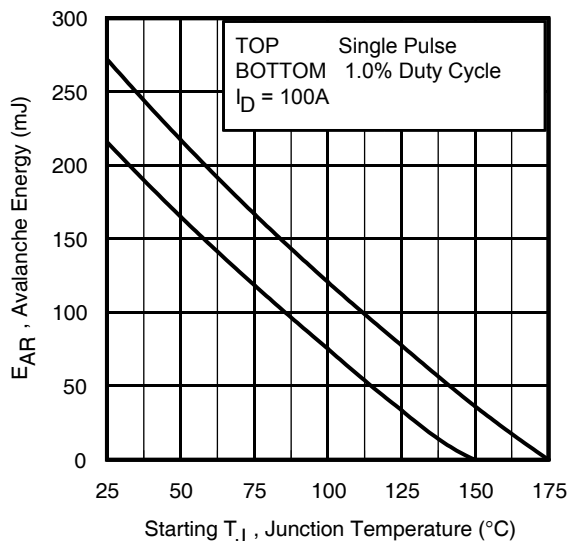
**Fig 5. Typical Transfer Characteristics**

**Fig 6. Normalized On-Resistance vs. Temperature**

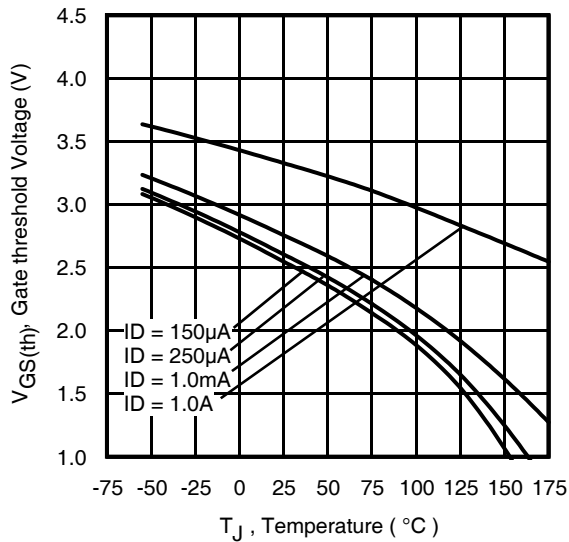
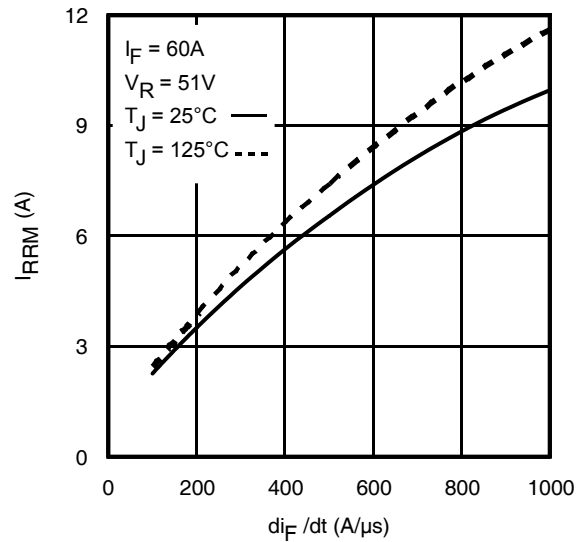
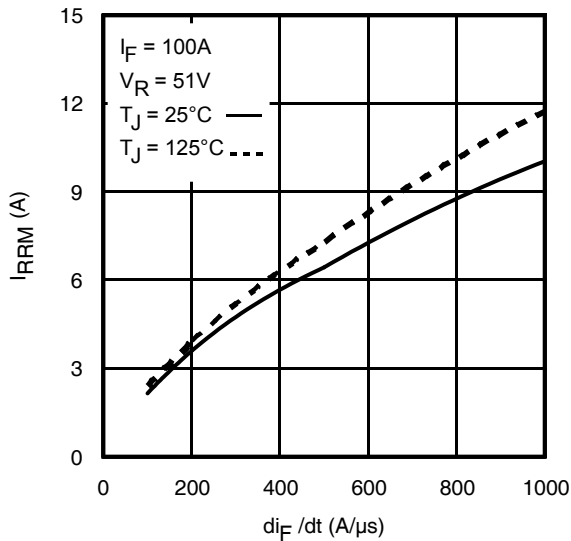
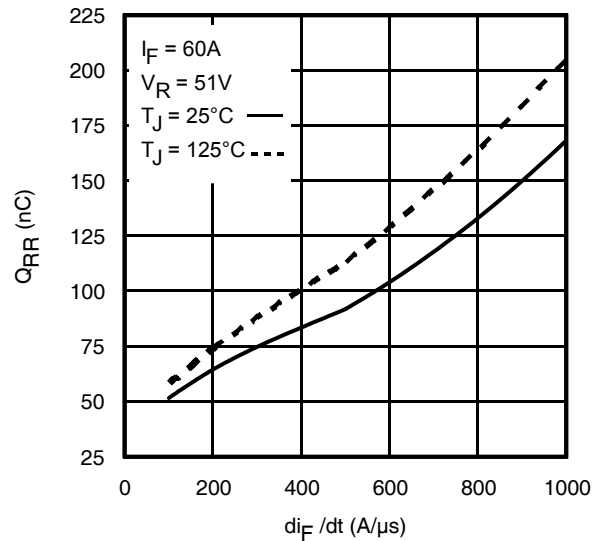
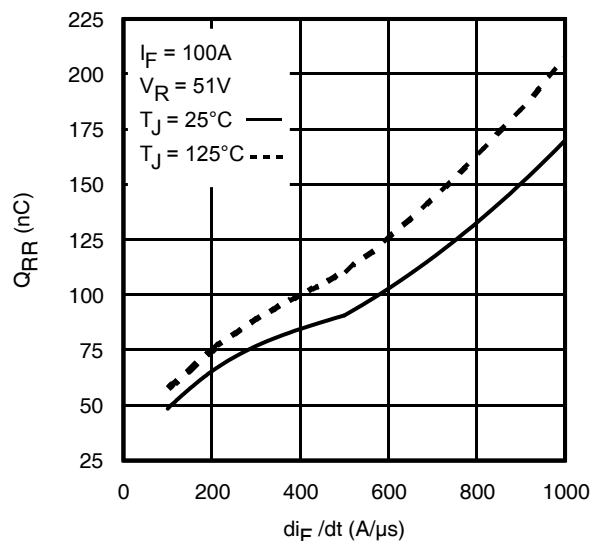
**Fig 7. Typical Capacitance vs. Drain-to-Source Voltage**

**Fig 8. Typical Gate Charge vs. Gate-to-Source Voltage**

**Fig 9.** Typical Source-Drain Diode Forward Voltage

**Fig 10.** Maximum Safe Operating Area

**Fig 11.** Drain-to-Source Breakdown Voltage

**Fig 12.** Typical  $C_{oss}$  Stored Energy

**Fig 13.** Typical On-Resistance vs. Drain Current

**Fig 14. Maximum Effective Transient Thermal Impedance, Junction-to-Case**

**Fig 15. Avalanche Current vs. Pulse Width**

**Fig 16. Maximum Avalanche Energy vs. Temperature**
**Notes on Repetitive Avalanche Curves , Figures 15, 16:  
(For further info, see AN-1005 at www.irf.com)**

1. Avalanche failures assumption:  
Purely a thermal phenomenon and failure occurs at a temperature far in excess of  $T_{jmax}$ . This is validated for every part type.
2. Safe operation in Avalanche is allowed as long as  $T_{jmax}$  is not exceeded.
3. Equation below based on circuit and waveforms shown in Figures 23a, 23b.
4.  $P_{D(ave)}$  = Average power dissipation per single avalanche pulse.
5. BV = Rated breakdown voltage (1.3 factor accounts for voltage increase during avalanche).
6.  $I_{av}$  = Allowable avalanche current.
7.  $\Delta T$  = Allowable rise in junction temperature, not to exceed  $T_{jmax}$  (assumed as 25°C in Figure 14, 15).  
 $t_{av}$  = Average time in avalanche.  
 $D$  = Duty cycle in avalanche =  $t_{av} \cdot f$   
 $Z_{thJC}(D, t_{av})$  = Transient thermal resistance, see Figures 14)  
 $P_{D(ave)} = 1/2 ( 1.3 \cdot BV \cdot I_{av} ) = \Delta T / Z_{thJC}$   
 $I_{av} = 2\Delta T / [1.3 \cdot BV \cdot Z_{th}]$   
 $E_{AS(AR)} = P_{D(ave)} \cdot t_{av}$

**Fig 17.** Threshold Voltage vs. Temperature

**Fig 18.** Typical Recovery Current vs. dif/dt

**Fig 19.** Typical Recovery Current vs. dif/dt

**Fig 20.** Typical Stored Charge vs. dif/dt

**Fig 21.** Typical Stored Charge vs. dif/dt

**Fig 22. Peak Diode Recovery dv/dt Test Circuit for N-Channel HEXFET® Power MOSFETs**

**Fig 23a. Unclamped Inductive Test Circuit**

**Fig 23b. Unclamped Inductive Waveforms**

**Fig 24a. Switching Time Test Circuit**

**Fig 24b. Switching Time Waveforms**

**Fig 25a. Gate Charge Test Circuit**

**Fig 25b. Gate Charge Waveform**



**TO-220AB Package Outline (Dimensions are shown in millimeters (inches))**

**NOTES:**

- 1.- DIMENSIONING AND TOLERANCING AS PER ASME Y14.5 M- 1994.
- 2.- DIMENSIONS ARE SHOWN IN INCHES [MILLIMETERS].
- 3.- LEAD DIMENSION AND FINISH UNCONTROLLED IN L1.
- 4.- DIMENSION D, D1 & E DO NOT INCLUDE MOLD FLASH. MOLD FLASH SHALL NOT EXCEED .005" (0.127) PER SIDE. THESE DIMENSIONS ARE MEASURED AT THE OUTERMOST EXTREMES OF THE PLASTIC BODY.
- 5.- DIMENSION b1, b3 & c1 APPLY TO BASE METAL ONLY.
- 6.- CONTROLLING DIMENSION : INCHES.
- 7.- THERMAL PAD CONTOUR OPTIONAL WITHIN DIMENSIONS E,H1,D2 & E1
- 8.- DIMENSION E2 X H1 DEFINE A ZONE WHERE STAMPING AND SINGULATION IRREGULARITIES ARE ALLOWED.
- 9.- OUTLINE CONFORMS TO JEDEC TO-220, EXCEPT A2 (max.) AND D2 (min.) WHERE DIMENSIONS ARE DERIVED FROM THE ACTUAL PACKAGE OUTLINE.

SYMBOL	DIMENSIONS				NOTES
	MILLIMETERS		INCHES		
	MIN.	MAX.	MIN.	MAX.	
A	3.56	4.83	.140	.190	
A1	1.14	1.40	.045	.055	
A2	2.03	2.92	.080	.115	
b	0.38	1.01	.015	.040	
b1	0.38	0.97	.015	.038	5
b2	1.14	1.78	.045	.070	
b3	1.14	1.73	.045	.068	5
c	0.36	0.61	.014	.024	
c1	0.36	0.56	.014	.022	5
D	14.22	16.51	.560	.650	4
D1	8.38	9.02	.330	.355	
D2	11.68	12.88	.460	.507	7
E	9.65	10.67	.380	.420	4,7
E1	6.86	8.89	.270	.350	7
E2	-	0.76	-	.030	8
e	2.54 BSC		.100 BSC		
e1	5.08 BSC		.200 BSC		
H1	5.84	6.86	.230	.270	7,8
L	12.70	14.73	.500	.580	
L1	3.56	4.06	.140	.160	3
øP	3.54	4.08	.139	.161	
Q	2.54	3.42	.100	.135	

**LEAD ASSIGNMENTS**
**HEXFET**

- 1.- GATE
- 2.- DRAIN
- 3.- SOURCE

**IGBTs, CoPACK**

- 1.- GATE
- 2.- COLLECTOR
- 3.- EMITTER

**DIODES**

- 1.- ANODE
- 2.- CATHODE
- 3.- ANODE

**TO-220AB Part Marking Information**

EXAMPLE: THIS IS AN IRF1010  
 LOT CODE 1789  
 ASSEMBLED ON WW 19, 2000  
 IN THE ASSEMBLY LINE "C"

Note: "P" in assembly line position  
 indicates "Lead - Free"



TO-220AB packages are not recommended for Surface Mount Application.

Note: For the most current drawing please refer to IR website at <http://www.irf.com/package/>

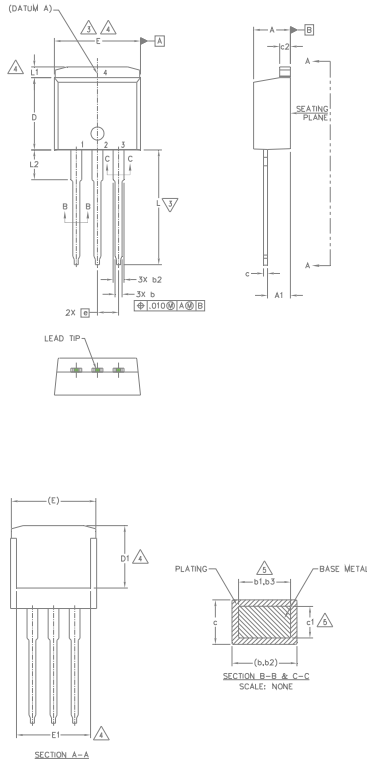
**TO-262 Package Outline (Dimensions are shown in millimeters (inches))**

SYMBOL	DIMENSIONS				NOTES
	MILLIMETERS		INCHES		
	MIN.	MAX.	MIN.	MAX.	
A	4.06	4.83	.160	.190	5
A1	2.03	3.02	.080	.119	
b	0.51	0.99	.020	.039	5
b1	0.51	0.89	.020	.035	
b2	1.14	1.78	.045	.070	5
b3	1.14	1.73	.045	.068	
c	0.38	0.74	.015	.029	5
c1	0.38	0.58	.015	.023	
c2	1.14	1.65	.045	.065	3
D	8.38	9.65	.330	.380	
D1	6.86	-	.270	-	4
E	9.65	10.67	.380	.420	3,4
E1	6.22	-	.245	-	4
e	2.54 BSC		.100 BSC		4
L	13.46	14.10	.530	.555	
L1	-	1.65	-	.065	
L2	3.56	3.71	.140	.146	

**NOTES:**

1. DIMENSIONING AND TOLERANCING PER ASME Y14.5M-1994
2. DIMENSIONS ARE SHOWN IN MILLIMETERS [INCHES]
3. DIMENSION D & E DO NOT INCLUDE MOLD FLASH. MOLD FLASH SHALL NOT EXCEED 0.127 [0.005"] PER SIDE. THESE DIMENSIONS ARE MEASURED AT THE OUTMOST EXTREMES OF THE PLASTIC BODY.
4. THERMAL PAD CONTOUR OPTIONAL WITHIN DIMENSION E, L1, D1 & E1.
5. DIMENSION b1 AND c1 APPLY TO BASE METAL ONLY.
6. CONTROLLING DIMENSION: INCH.
- 7.- OUTLINE CONFORM TO JEDEC TO-262 EXCEPT A1(max.), b(min.) AND D1(min.) WHERE DIMENSIONS DERIVED THE ACTUAL PACKAGE OUTLINE.

**LEAD ASSIGNMENTS**
**IGBTs, CoPACK**

- 1.- GATE
- 2.- COLLECTOR
- 3.- EMITTER
- 4.- COLLECTOR

**HEXFET**

- 1.- GATE
- 2.- DRAIN
- 3.- SOURCE
- 4.- DRAIN

**DIODES**

- 1.- ANODE (TWO DIE) / OPEN (ONE DIE)
- 2, 4.- CATHODE
- 3.- ANODE

**TO-262 Part Marking Information**

**EXAMPLE:** THIS IS AN IRL3103L  
 LOT CODE 1789  
 ASSEMBLED ON VWV19, 1997  
 IN THE ASSEMBLY LINE "C"

Note: "P" in assembly line position indicates "Lead - Free"

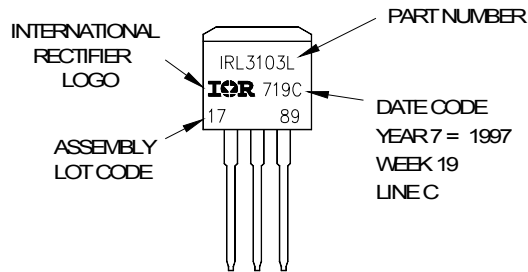

OR

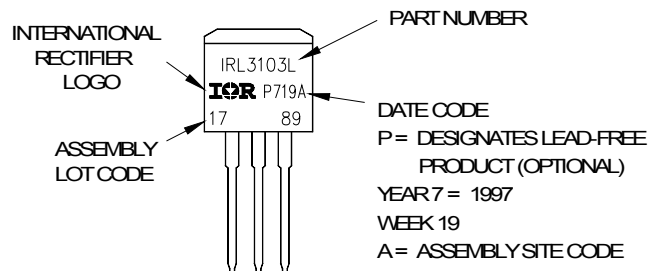

Note: For the most current drawing please refer to IR website at <http://www.irf.com/package/>

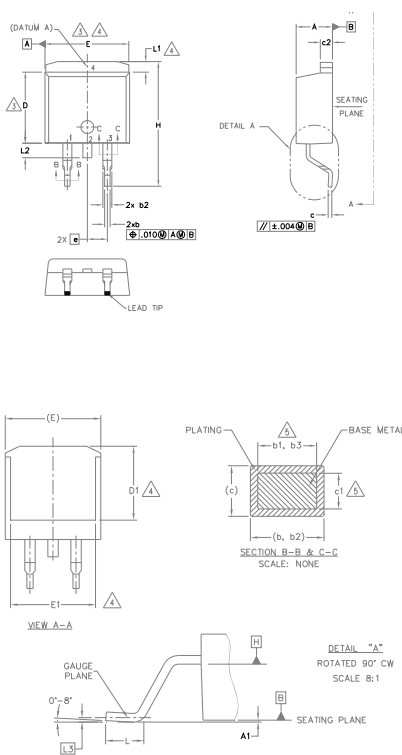
**D<sup>2</sup>Pak (TO-263AB) Package Outline (Dimensions are shown in millimeters (inches))**

SYMBOL	DIMENSIONS				NOTES
	MILLIMETERS		INCHES		
	MIN.	MAX.	MIN.	MAX.	
A	4.06	4.83	.160	.190	5
A1	0.00	0.254	.000	.010	
b	0.51	0.99	.020	.039	5
b1	0.51	0.89	.020	.035	
b2	1.14	1.78	.045	.070	5
b3	1.14	1.73	.045	.068	
c	0.38	0.74	.015	.029	5
c1	0.38	0.58	.015	.023	
c2	1.14	1.65	.045	.065	3
D	8.38	9.65	.330	.380	
D1	6.86	-	.270	-	4
E	9.65	10.67	.380	.420	
E1	6.22	-	.245	-	4
e	2.54 BSC	-	.100 BSC	-	
H	14.61	15.88	.575	.625	4
L	1.78	2.79	.070	.110	
L1	-	1.68	-	.066	4
L2	-	1.78	-	.070	
L3	0.25 BSC	-	.010 BSC	-	

**NOTES:**

- DIMENSIONING AND TOLERANCING PER ASME Y14.5M-1994
- DIMENSIONS ARE SHOWN IN MILLIMETERS [INCHES].
- DIMENSION D & E DO NOT INCLUDE MOLD FLASH. MOLD FLASH SHALL NOT EXCEED 0.127 [".005"] PER SIDE. THESE DIMENSIONS ARE MEASURED AT THE OUTMOST EXTREMES OF THE PLASTIC BODY AT DATUM H.
- THERMAL PAD CONTOUR OPTIONAL WITHIN DIMENSION E, L1, D1 & E1.
- DIMENSION b1, b3 AND c1 APPLY TO BASE METAL ONLY.
- DATUM A & B TO BE DETERMINED AT DATUM PLANE H.
- CONTROLLING DIMENSION: INCH.
- OUTLINE CONFORMS TO JEDEC OUTLINE TO-263AB.

**LEAD ASSIGNMENTS**
**DIODES**

- ANODE (TWO DIE) / OPEN (ONE DIE)
- CATHODE
- ANODE

**HEXFET**

- GATE
- DRAIN
- SOURCE

**IGBTs, CoPACK**

- GATE
- COLLECTOR
- EMITTER

**D<sup>2</sup>Pak (TO-263AB) Part Marking Information**

EXAMPLE: THIS IS AN IRF530S WITH  
LOT CODE 8024  
ASSEMBLED ON VWV 02, 2000  
IN THE ASSEMBLY LINE "L"

Note: "P" in assembly line position  
indicates "Lead - Free"

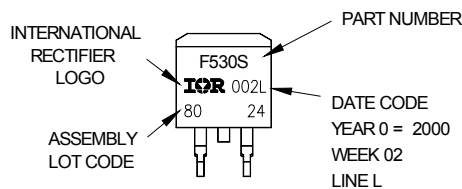

OR

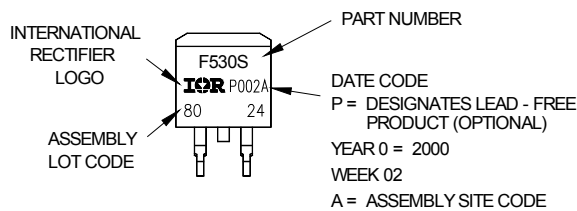

Note: For the most current drawing please refer to IR website at <http://www.irf.com/package/>

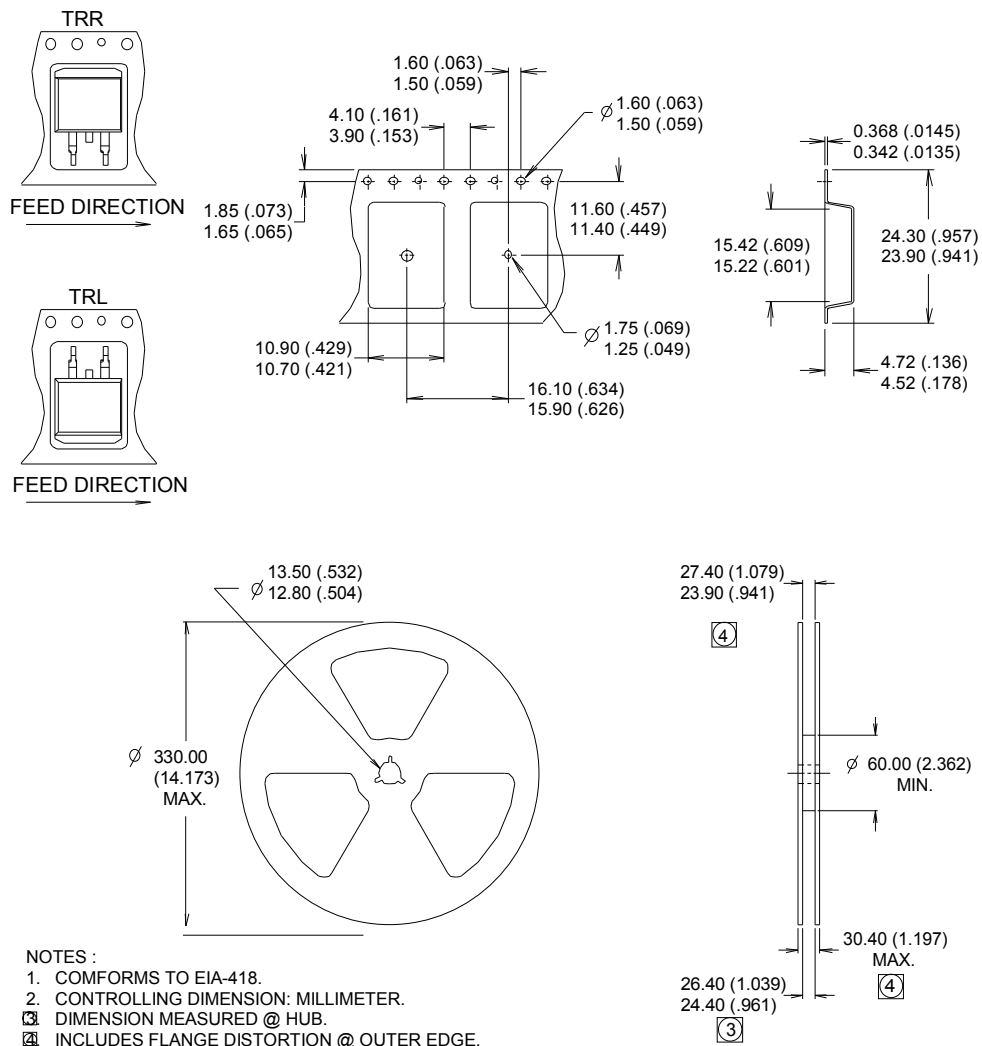
**D<sup>2</sup>Pak (TO-263AB) Tape & Reel Information** (Dimensions are shown in millimeters (inches))

Note: For the most current drawing please refer to IR website at <http://www.irf.com/package/>

**Qualification Information<sup>†</sup>**

<b>Qualification Level</b>	Industrial (per JEDEC JESD47F) <sup>††</sup>	
<b>Moisture Sensitivity Level</b>	TO-220	N/A
	D <sup>2</sup> Pak	MSL1
	TO-262	N/A
<b>RoHS Compliant</b>	Yes	

† Qualification standards can be found at International Rectifier's web site: <http://www.irf.com/product-info/reliability/>

†† Applicable version of JEDEC standard at the time of product release.

**Revision History**

<b>Date</b>	<b>Comments</b>
10/07/14	<ul style="list-style-type: none"> <li>Updated <math>E_{AS(L=1mH)} = 554mJ</math> on page 2</li> <li>Updated note 9 "Limited by <math>T_{Jmax}</math>, starting <math>T_J = 25^{\circ}C</math>, <math>L = 1mH</math>, <math>R_G = 50\Omega</math>, <math>I_{AS} = 33A</math>, <math>V_{GS} = 10V</math>". on page 2</li> <li>Updated package outline on page 9,10,11,12.</li> </ul>