

Receptacles

Features:

- DIN Rail, Panel Mount or Wall Mount
- Rating: 15A/125V AC
- Finger Protection: IP54
- Available in 3 colors.

PANEL MOUNT





WALL MOUNT



DIN RAIL MOUNT



External Dimension (HxWxL mm)	36.5 x 61.5 x 50	50 x 71 x 53.5	58.5 x 84 x 53.5
Stripping Length	10 mm	10 mm	10 mm
Insulation Material	Thermoplastic	Thermoplastic	Thermoplastic
Type of Connection	3 screw clamps	3 screw clamps	3 screw clamps
Approvals*	 E154664	 E154664	 E154664
Voltage Rating	125 V	125 V	125 V
Current Rating	15 A	15 A	15 A

Cat. No. Std. Pk.

Cat. No. Std. Pk.

Cat. No. Std. Pk.

Complete Kit:

Blue	PMRBU	1	WMRBU*	1	DMRBU*	1
Gray	PMRGR	1	WMRGR*	1	DMRGR*	1
Black	PMRBA	1	WMRBA	1	DMRBA	1

Optional Accessory Sealing Gasket for Panel Mount Receptacles

SEALGASK 1

Includes Sealing Gasket

Includes Sealing Gasket

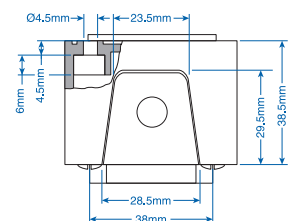
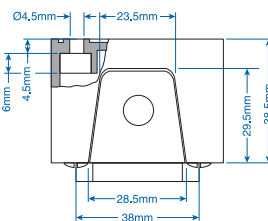
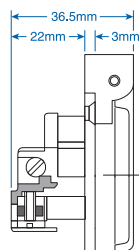
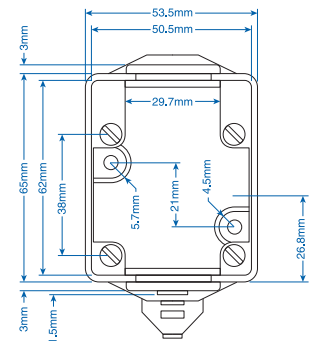
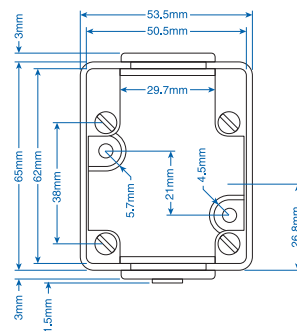
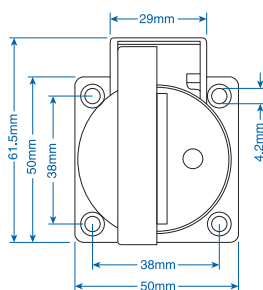

* Please Note:

Matching colored blue and gray assembly enclosures have been discontinued and are available while our stock supplies last.

Please check with customer service for availability.

The front socket and hinged protective cover are still available in blue and gray.

UL approval applies to outlet only, not enclosure or DIN rail clip.

PANEL MOUNT

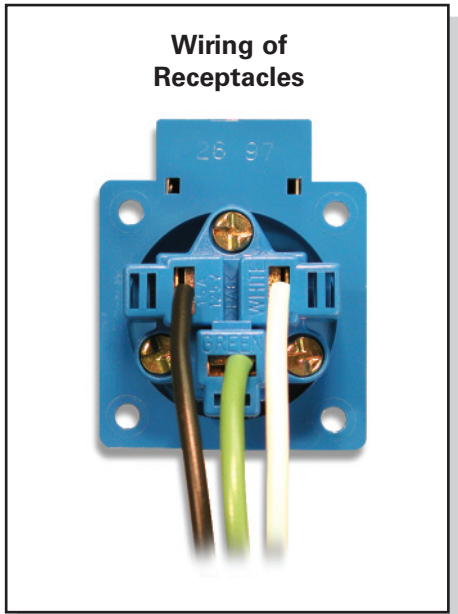
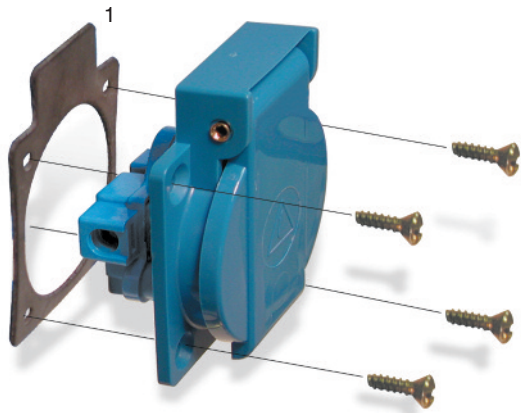

WALL MOUNT

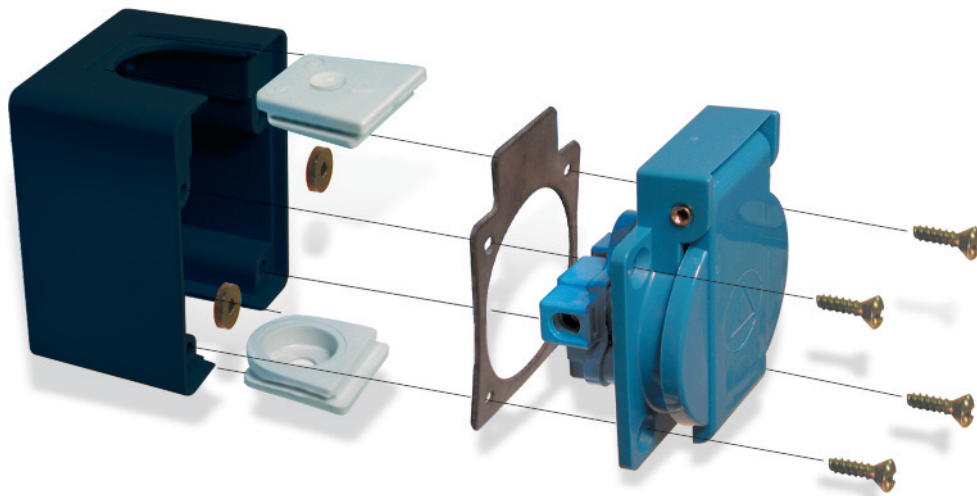

DIN RAIL MOUNT

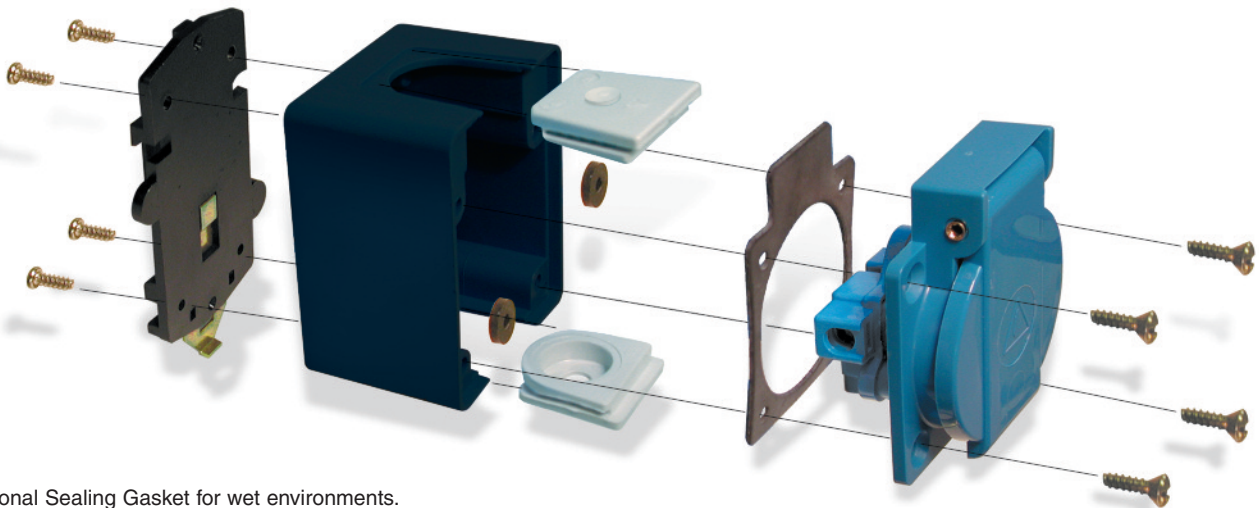

¹ Optional Sealing Gasket for wet environments.