

COPAL ELECTRONICS

DISPLAY TYPE
COMPOUND PRESSURE SWITCH

PS60

CE marking
(Compliance with EMC Standards)

INSTRUCTION MANUAL Ver.2.1

Thank you for purchasing a
NIDEC COPAL ELECTRONICS CORP. product.
For proper and optimal use of the product, please read this
manual thoroughly before using.
Keep this manual for future reference.

⚠ Important Information and Warnings

- ① Non-corrosive gases should be used as pressure media for PS60.
- ② The maximum applicable pressure for the PS60-102R/302R at the time of vacuum break is 500kPa.
- ③ Always carry out wiring work with the power off.
- ④ Press the  button more than 3 seconds in the Operation Mode, the panel lock function will be completed and disabled to the key operation. Please refer to the following “Panel lock function” and cancel the panel lock function.
- ⑤ For stability, use a regulated direct current power supply.
Surge absorbing devices (diodes, varistors, etc.) are necessary if inductive loads such as relays and solenoids are connected to the same power line as the PS60. Do not wire in parallel to high voltage cables or power lines, or use the same cable ducts which contain high voltage cables or power lines.
- ⑥ Check fluctuations in power voltage so that the power input cannot exceed the rating. Also please do not give a rapid voltage fluctuation like interrupting the energization immediately after starting and during setting operation. Memory data may disappear, and which results in a defect of operation/
- ⑦ Be careful not to apply force to the display area of the main body during piping.
- ⑧ Use pH neutral detergents to clean the body. Do not use lacquer thinner and other solvents for cleaning.
- ⑨ Do not use pointed objects such as pens to press the setting buttons on the display panel. Doing so may damage the setting buttons by piercing them.
- ⑩ Do not put a piece of wire or other long thin object from pressure port. Doing so may damage the internal diaphragm to cause malfunctioning.
- ⑪ Do not use the product in a place where much steam and/or dust exist or the product may be subjected to direct water or oil splash.
- ⑫ **【Recommended measures against noise interference】**
It is recommended to use noise absorbing components (line filter, surge absorber, etc.) in the power supply terminal of the PS60.

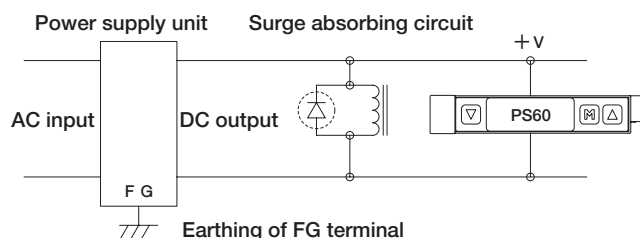

For more detailed information please ask for the nearest distributor or the following sales center.

COPAL ELECTRONICS

Nishi-Shinjuku Kimuraya Bldg., 7-5-25
Nishi-Shinjuku Shinjuku-ku Tokyo 160-0023, Japan Phone.: (03) 3364-7055

Specifications

Model	PS60		
	102R	302R	103R
Type (Pressure reference)	Gauge pressure		
Rated pressure range	-100~100kPa	-100~300kPa	-0.10~1.00MPa
Maximum pressure	200kPa	600kPa	1.5MPa
Break-down pressure	500kPa	1.0MPa	2.0MPa
Acceptable media	Non-corrosive gases		
Power supply	12V~24VDC±10%, ripple P-P 10% or less		
Current consumption	30mA maximum		
Switch outputs	NPN (Two outputs) ,PNP (Two outputs) Transistor, open collector Switch rating: 30VDC, 100mA maximum Residual voltage: 1.2V maximum (NPN) / 2.2V maximum (PNP) at 100mA		
	Hysteresis	0~30 count setting (adjustable)	
	Repeatability	±0.3%FS	
	Response	5ms maximum	
	Short circuit protection	Included	
Pressure indication	Signed 3 digits, 7-segment-LED indication (sampling cycle: approx. 4 times per second)		
	Accuracy	±1%FS±1 digit	
Switch status indication	Output 1 (P1) and output 2 (P2) , LED (red) light up when switch outputs are ON.		
Operating conditions	IP protection	Meets IP40 of IEC	
	Operating temperature	-10~50°C (storage-20~70°C)	
	Operating humidity	35~85 %RH	
	Vibration resistance	10~500Hz, amplitude 1.5mm/98.1 ^{m/s²} , three directions, two hours each	
	Shock resistance	490 ^{m/s²} , three directions, three times each	
	EMC	EMI: EN55011 Group1,ClassB:1998 EMS: EN61326-1:1997/A-1:1998/The permissible variations in display counts and set value of switch output not exceed±5%FS.	
Thermal error	±3%FS (0~50°C, reference temp. 25°C)		
Pressure port	M5 female screw		
Pressure receiving area material	Single crystal silicon		
Net weight	Approx. 50g (included 1.5m cable)		
Accessories	Connector with cable (1.5m) , DIN rail adapter		

Output Electrical Diagram (Wire colors correspond to I.E.C standards)

NPN (Two outputs type)

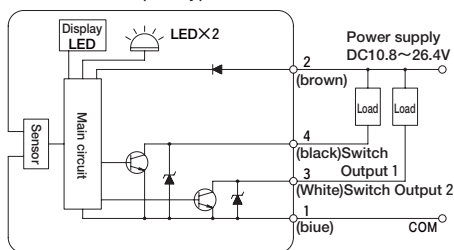

PNP (Two output type)

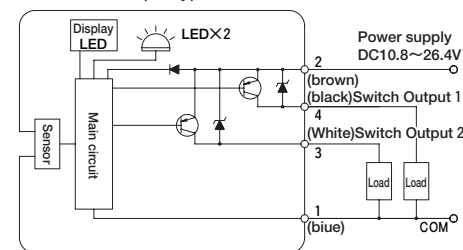

Details of the front panel

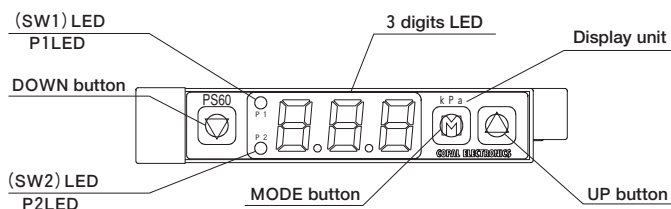

Error Messages

■ If the following error messages are displayed, follow the procedures in the table:

Error message	Problem	Solution
	Overload current. (Brinking of SW1 or SW2 indicates excessive current on SW1 or SW2.)	Disconnect the power, then check the load condition.
	Pressure detected when adjusting the zero point.	Press the button and reset the display. Release the applied pressure in the pressure port (opened to the atmosphere) and adjust the zero point again.
	Applied pressure is higher than the maximum value of the pressure display range.	Check the applied pressure.

Functions

Initial LED Display



Non-display mode (Low power mode)

● When you do not operate any buttons for about 10 seconds, the system will automatically select non-display mode and the LED indicator section will go off.

Pressing any key will cause the LED indicator section to come on back again.

(Note 1) The decimal point shown in the figure on the right blinks during non-display mode.

(Note 2) Switch outputs and switch LEDs are operable even during non-display mode.

(Note 3) Error messages will appear during non-display mode.

※ For how to select non-display mode, see the description of the initial setting mode.



Conversion factor

● You can select a conversion factor from the options shown in the table on the right.

(Note 1) Slashed box: No factors options are available due to inappropriate resolution and the number of digits for display.

※ For how to set the conversion factor, see the description of the initial setting mode.

Number selected	Pressure range		
	102R	302R	103R
1 (kPa)	-100~100	-100~300	—
2 (MPa)	—	—	-0.10~1.00
3	-75~75	-75~225	—
4	-1.00~1.00	-1.00~3.00	-1.0~10.0
5	-14.5~14.5	-14.5~43.5	-14~145
6	29.5~0.0 (*, " symbol does not display)	29.5~0.0 (*, " symbol does not display)	—

Switch working mode

● You can select switch working mode from the options shown in the table below.

(Note 1) In the Separate Mode, SW1 and SW2 work separately.

(Note 2) In the Window Comparator Mode, the minimum value for SW1 and SW2 corresponds to Setting 1 and the maximum value to Setting 2.

※ For how to set the switch output, see the description of the initial setting mode.

Number selected	Output Mode	SW1				SW2			
		Separate	Window Comparator			Separate	Window Comparator		
	Operation	H	L	A	B	H	L	A	B
1		○				○			
2		○				○			
3			○				○		
4			○				○		
5				○				○	
6				○				○	
7					○				○
8						○			○
		Setting 1	Minimum: Setting 1 Maximum: Setting 2			Setting 2	Minimum: Setting 1 Maximum: Setting 2		

There are four operation modes. There are shown in the diagrams below.

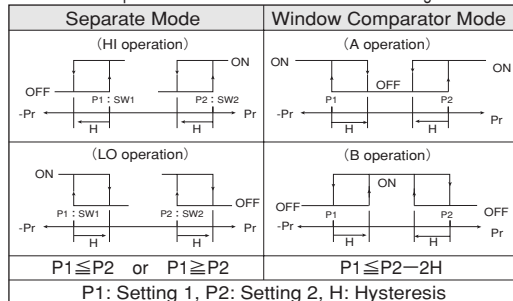

Digital filter

● Two different digital filters (25ms and 250ms) are available.

The digital filters are useful when it is hard to take readings due to too great fluctuations in pressure.

(Note 1) Any selected digital filter will be reflected on the pressure display and switch action.

※ For how to set the digital filter, see the description of the pressure setting mode.

Operational Procedures

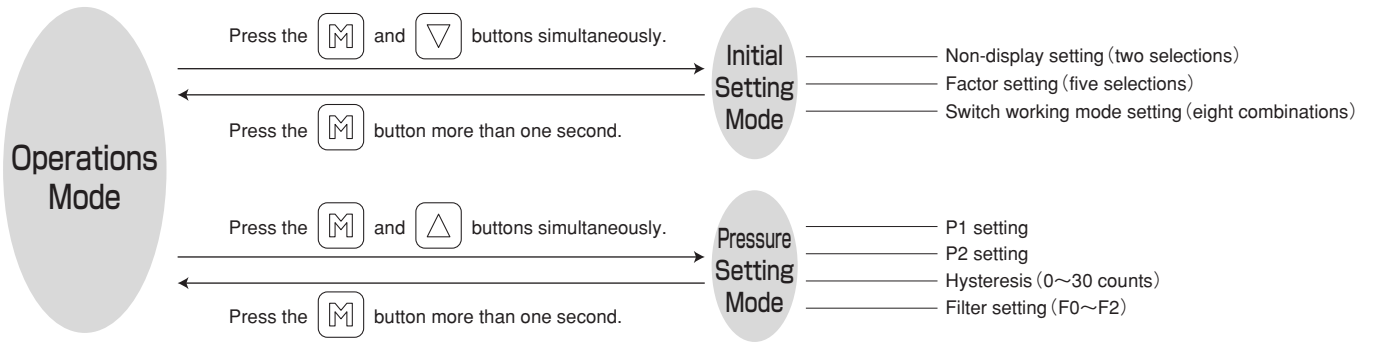

Initial Setting Mode

This mode is used to set non-display mode, magnification and switch outputs.

Entering Initial Setting Mode

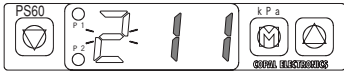

Press the **▽** and **M** buttons simultaneously in Operations Mode.

After switched to Initial Setting Mode, the third digit will blink.

(The values **2 1 1** for the 102R / 302R model and **2 2 1** for the 103R have been set in the factory.)

Making initial setting

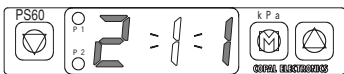

Press the **M** button to move to the next digit. The value of the digit may be set when the LED below the digit blinks.

The number will change every time the **▽** or **△** button is pressed.

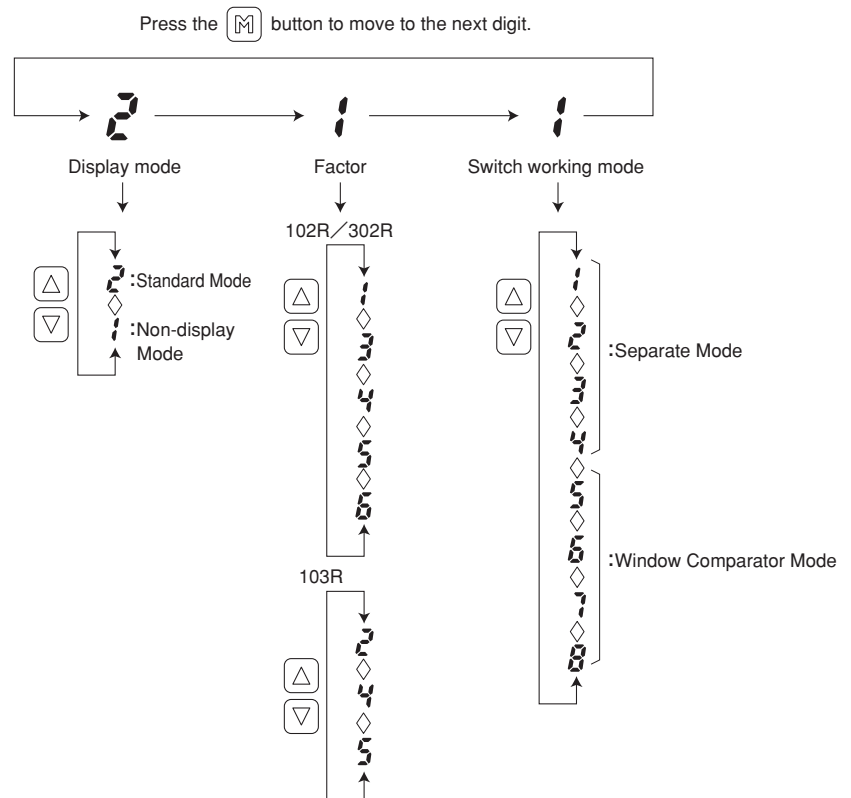

Pressure Setting Mode

This mode is used to make Setting 1, Setting 2, hysteresis and digital filter setting.

Entering Pressure Setting Mode



Press the **M** and **Δ** buttons simultaneously in Operations Mode.
After switched to Pressure Setting Mode, P1 LED should be blinking to indicate the value for Setting 1.

Setting pressure value

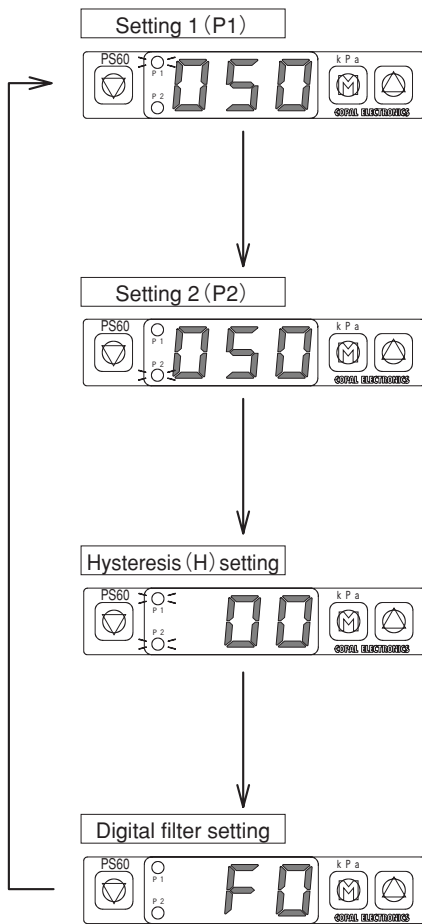

The P1 LED should be blinking.
Use the **▽** or **Δ** button to select a value for Setting 1 (P1).
(The values **050** for 102R and **050** for 103R have been set in the factory.)
(Note 1) The setting can only be made within the allowable display range.
(Note 2) The setting should meet $P1 \leq P2 - 2H$ when Window Comparator Mode is selected.

The P2 LED should be blinking.
Use the **▽** or **Δ** button to select a value for Setting 2 (P2).
(The values **050** for 102R and **050** for 103R have been set in the factory.)
(Note 1) The setting can only be made within the allowable display range.
(Note 2) The setting should meet $P1 \leq P2 - 2H$ when Window Comparator Mode is selected.

The P1 and P2 LEDs should be blinking.
Use the **▽** or **Δ** button to set the hysteresis (H).
(The values **00** for 102R / 302R and **00** for 103R have been set in the factory.)
(Note 1) The setting should be 30 counts or less.
(Note 2) The setting should meet $P1 \leq P2 - 2H$ when Window Comparator Mode is selected.

Use the **▽** or **Δ** button to set the digital filter.
F0: No filter, **F1**: 25ms filter, **F2**: 250ms filter
(The value **F0** has been set in the factory.)

Zero Point Adjustment

Adjust the pressure indication at the time of pressure release in the pressure port to "zero".

Zero-point adjustment

Adjust the pressure indication to "zero" when the pressure port is released.

- Open the pressure port to the atmospheric pressure first.
- Press **▽** and **Δ** buttons simultaneously in the Operation mode.
- When finger is released from each button, **00** blinks twice.

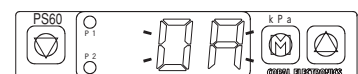

Zero-point adjustment is completed when **00** light goes out.
Zero-point adjustment value is not erased even if the power supply is turned off.

Panel Protection

Panel lock function

The panel lock function is used to lock the key operation in order to prevent preset values from being accidentally changed.

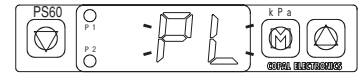

Panel lock function is not erased even if the power supply is turned off.

- To enable the panel lock function, press button more than 3 seconds.
 blinks twice and the buttons are locked.
- To disable the panel lock function, press button more than 3 seconds.
 blinks twice and the buttons are locked.

Piping and Installation

Piping

When connecting a available joint to the pressure port, hold the base section of the main body and make sure that the tightening torque is 1.0N·m (M5 female) or less.

Note) Please do not directly hold the case only when tightening. Also, do not use the wrench to any other part than the port section when tightening. Such handling may cause a breakage of the switch.

DIN rail attachment

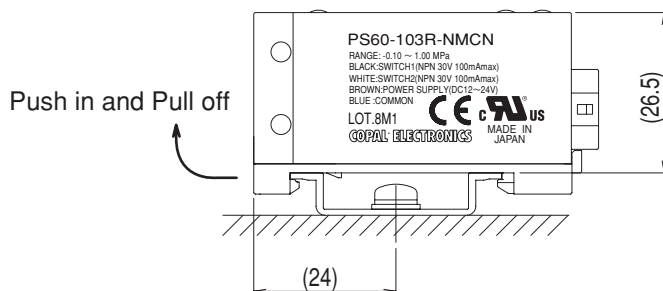
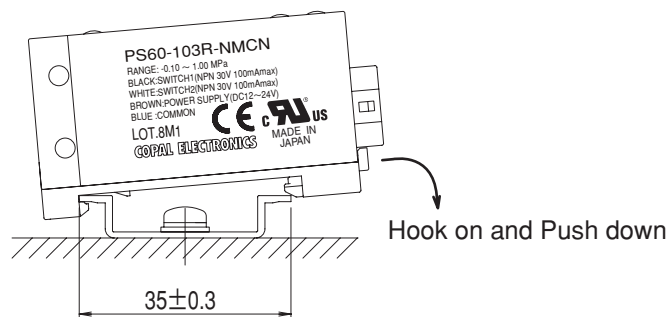
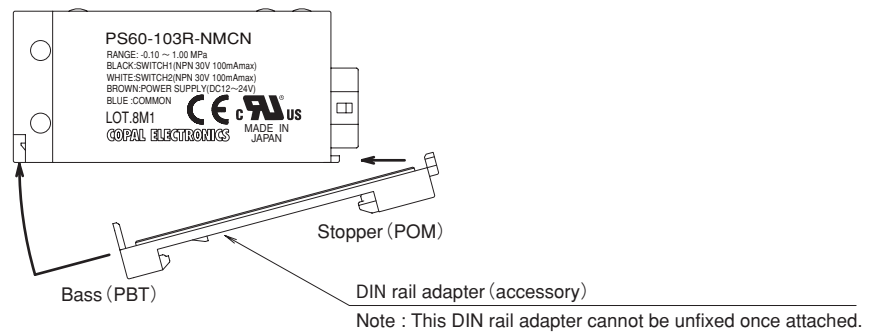

Outline Dimensions (Unit: mm)

PS60

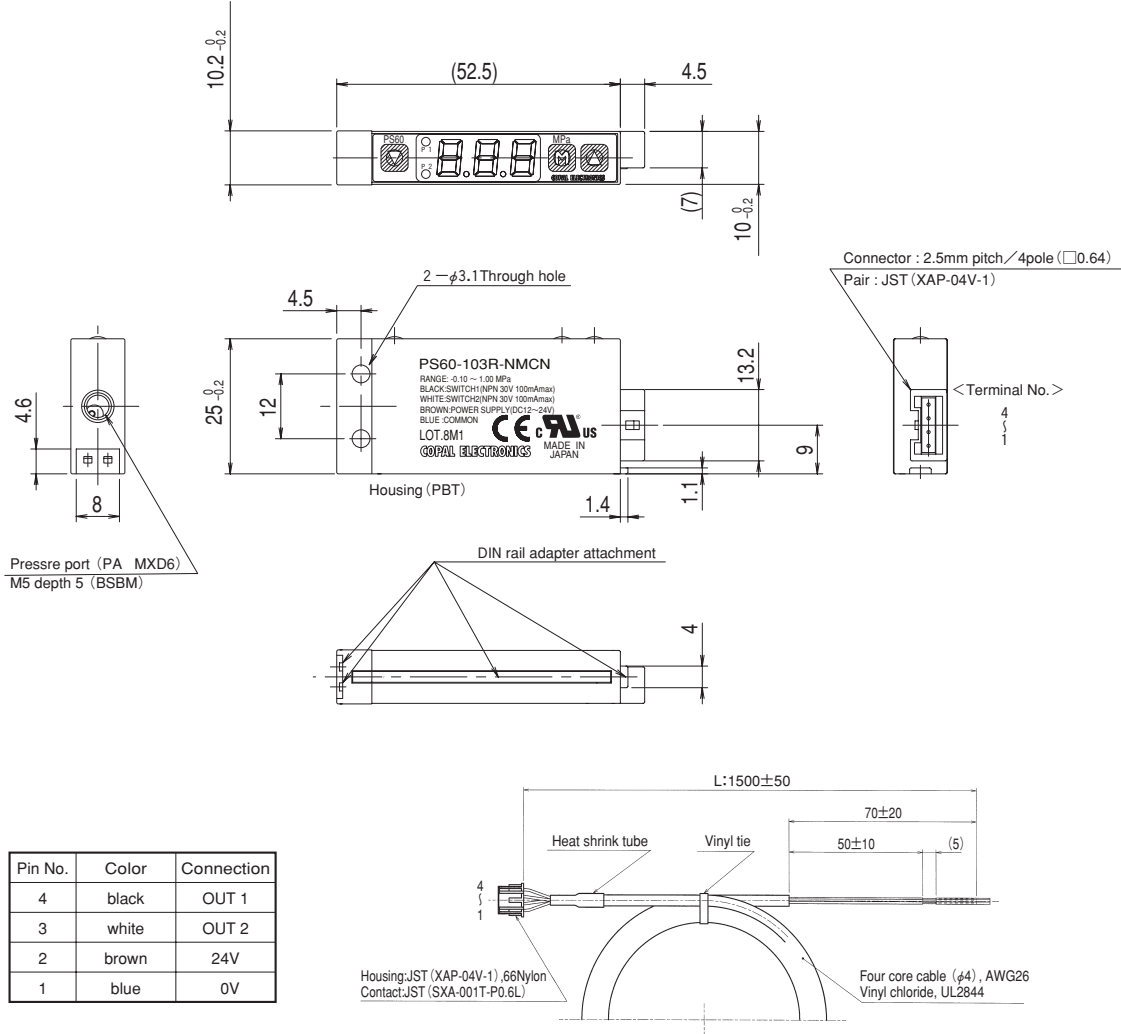

Pin No.	Color	Connection
4	black	OUT 1
3	white	OUT 2
2	brown	24V
1	blue	0V

Warranty

This product can be covered by one-year warranty. COPAL ELECTRONICS warrants that any part of the product which proves to be defective due to the design and/or manufacturing of COPAL ELECTRONICS within one year from the date of delivery will be repaired or replaced, free of charge. Note that the warranty will only be applied to the product alone, not to damages induced by any failure of the product.

The warranty will not be applied in any of the following cases:

- ① Failure and damage caused by improper use not conforming to the instruction manual or negligent handling.
- ② Failure and damage caused by inappropriate modification, adjustment or repair.
- ③ Failure and damage caused by natural disaster, fire or other act of God.

Model Numbers

