

Automotive P-Channel 60 V (D-S) MOSFET

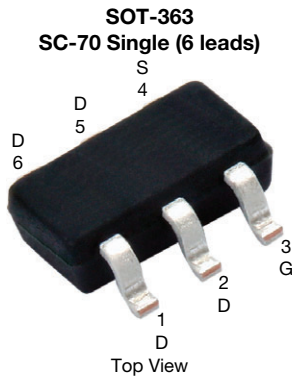

Marking Code: 9D

| PRODUCT SUMMARY | |
|--|--------|
| V_{DS} (V) | -60 |
| $R_{DS(on)}$ (Ω) at $V_{GS} = -10$ V | 0.290 |
| $R_{DS(on)}$ (Ω) at $V_{GS} = -4.5$ V | 0.395 |
| I_D (A) | -1.6 |
| Configuration | Single |
| Package | SC-70 |

FEATURES

- TrenchFET® power MOSFET
- AEC-Q101 qualified
- 100 % R_g and UIS tested
- Typical ESD protection: 800 V
- Material categorization:
for definitions of compliance please see www.vishay.com/doc?99912

 AUTOMOTIVE
GRADE

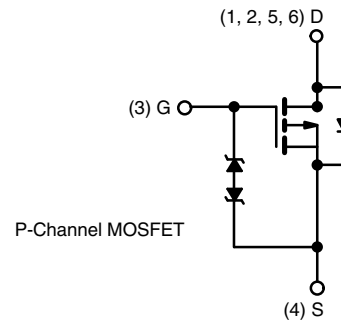
RoHS
COMPLIANT
HALOGEN
FREE

| ABSOLUTE MAXIMUM RATINGS ($T_C = 25$ °C, unless otherwise noted) | | | | |
|---|----------------------------|----------------|-------------|------|
| PARAMETER | | SYMBOL | LIMIT | UNIT |
| Drain-source voltage | | V_{DS} | -60 | V |
| Gate-source voltage | | V_{GS} | ± 20 | |
| Continuous drain current | $T_C = 25$ °C ^a | I_D | -1.6 | A |
| | $T_C = 125$ °C | | -1 | |
| Continuous source current (diode conduction) ^a | | I_S | -1.6 | |
| Pulsed drain current ^b | | I_{DM} | -6.7 | |
| Single pulse avalanche current | L = 0.1 mH | I_{AS} | -8 | |
| Single pulse avalanche energy | | E_{AS} | 3.2 | |
| Maximum power dissipation ^b | $T_C = 25$ °C | P_D | 2.7 | W |
| | $T_C = 125$ °C | | 0.5 | |
| Operating junction and storage temperature range | | T_J, T_{stg} | -55 to +150 | °C |

| THERMAL RESISTANCE RATINGS | | | | |
|----------------------------|------------------------|------------|-------|------|
| PARAMETER | | SYMBOL | LIMIT | UNIT |
| Junction-to-ambient | PCB mount ^c | R_{thJA} | 125 | °C/W |
| Junction-to-foot (drain) | | R_{thJF} | 45 | |

Notes

- Package limited
- Pulse test; pulse width ≤ 300 μ s, duty cycle ≤ 2 %
- When mounted on 1" square PCB (FR4 material)



| SPECIFICATIONS (T _C = 25 °C, unless otherwise noted) | | | | | | | |
|--|---------------------|--|--|------|-------|-------|------|
| PARAMETER | SYMBOL | TEST CONDITIONS | | MIN. | TYP. | MAX. | UNIT |
| Static | | | | | | | |
| Drain-source breakdown voltage | V _{DS} | V _{GS} = 0 V, I _D = -250 μA | | -60 | - | - | V |
| Gate-source threshold voltage | V _{GS(th)} | V _{DS} = V _{GS} , I _D = -250 μA | | -1.5 | -2.0 | -2.5 | |
| Gate-source leakage | I _{GSS} | V _{DS} = 0 V, V _{GS} = ± 12 V | | - | - | ± 5 | μA |
| | | V _{DS} = 0 V, V _{GS} = ± 20 V | | - | - | ± 5 | mA |
| Zero gate voltage drain current | I _{DSS} | V _{GS} = 0 V | V _{DS} = -60 V | - | - | -1 | μA |
| | | V _{GS} = 0 V | V _{DS} = -60 V, T _J = 125 °C | - | - | -50 | |
| | | V _{GS} = 0 V | V _{DS} = -60 V, T _J = 150 °C | - | - | -150 | |
| On-state drain current ^a | I _{D(on)} | V _{GS} = -10 V | V _{DS} ≤ -5 V | -5 | - | - | A |
| Drain-source on-state resistance ^a | R _{DS(on)} | V _{GS} = -10 V | I _D = -2 A | - | 0.230 | 0.290 | Ω |
| | | V _{GS} = -10 V | I _D = -2 A, T _J = 125 °C | - | - | 0.470 | |
| | | V _{GS} = -10 V | I _D = -2 A, T _J = 150 °C | - | - | 0.566 | |
| | | V _{GS} = -4.5 V | I _D = -1 A | - | 0.305 | 0.395 | |
| Forward transconductance ^b | g _{fs} | V _{DS} = -10 V, I _D = -1.5 A | | - | 3 | - | S |
| Dynamic ^b | | | | | | | |
| Input capacitance | C _{iss} | V _{GS} = 0 V | V _{DS} = -25 V, f = 1 MHz | - | 284 | 355 | pF |
| Output capacitance | C _{oss} | | | - | 36 | 45 | |
| Reverse transfer capacitance | C _{rss} | | | - | 28 | 35 | |
| Total gate charge ^c | Q _g | V _{GS} = -4.5 V | V _{DS} = -30 V, I _D = -1 A | - | 3.6 | 5.4 | nC |
| Gate-source charge ^c | Q _{gs} | | | - | 1.2 | - | |
| Gate-drain charge ^c | Q _{gd} | | | - | 1.7 | - | |
| Gate resistance | R _g | f = 1 MHz | | 3.1 | 6.05 | 9 | Ω |
| Turn-on delay time ^c | t _{d(on)} | V _{DD} = -30 V, R _L = 30 Ω I _D ≅ -1 A, V _{GEN} = -4.5 V, R _g = 1 Ω | | - | 44 | 66 | ns |
| Rise time ^c | t _r | | | - | 25 | 38 | |
| Turn-off delay time ^c | t _{d(off)} | | | - | 13 | 20 | |
| Fall time ^c | t _f | | | - | 9 | 14 | |
| Source-Drain Diode Ratings and Characteristics ^b | | | | | | | |
| Pulsed current ^a | I _{SM} | | | - | - | -6.7 | A |
| Forward voltage | V _{SD} | I _F = -0.5 A, V _{GS} = 0 V | | - | -0.8 | -1.2 | V |

Notes

- Pulse test; pulse width ≤ 300 μs, duty cycle ≤ 2 %
- Guaranteed by design, not subject to production testing
- Independent of operating temperature

Stresses beyond those listed under "Absolute Maximum Ratings" may cause permanent damage to the device. These are stress ratings only, and functional operation of the device at these or any other conditions beyond those indicated in the operational sections of the specifications is not implied. Exposure to absolute maximum rating conditions for extended periods may affect device reliability.



TYPICAL CHARACTERISTICS (25 °C, unless otherwise noted)

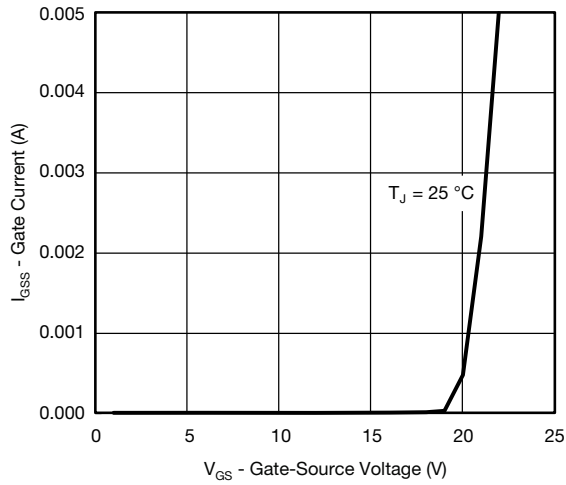

Gate Current vs. Gate-Source Voltage

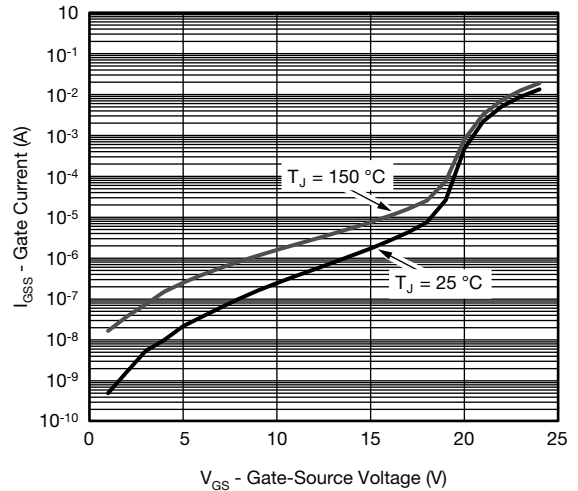

Gate Current vs. Gate-Source Voltage

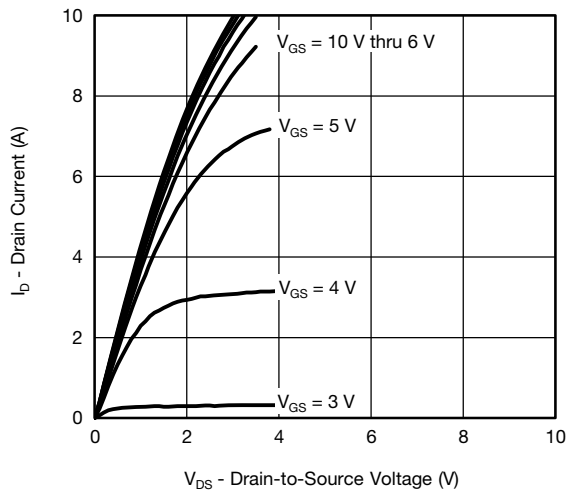

Output Characteristics

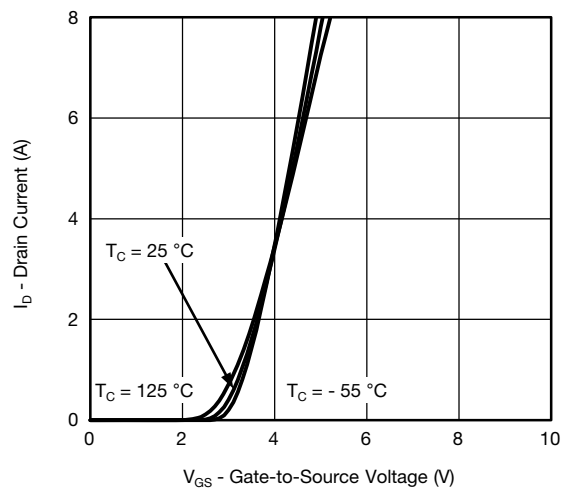

Transfer Characteristics

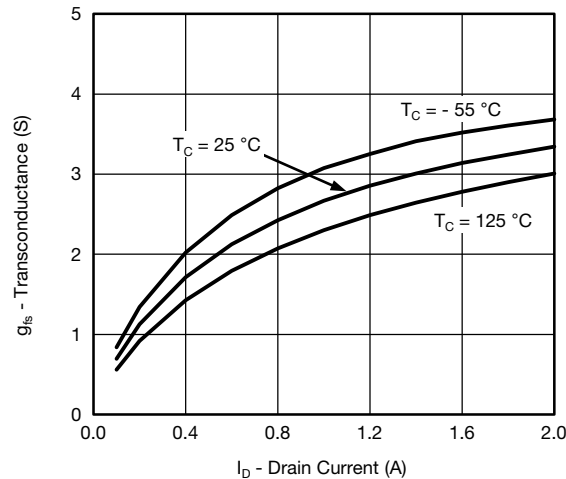

Transconductance

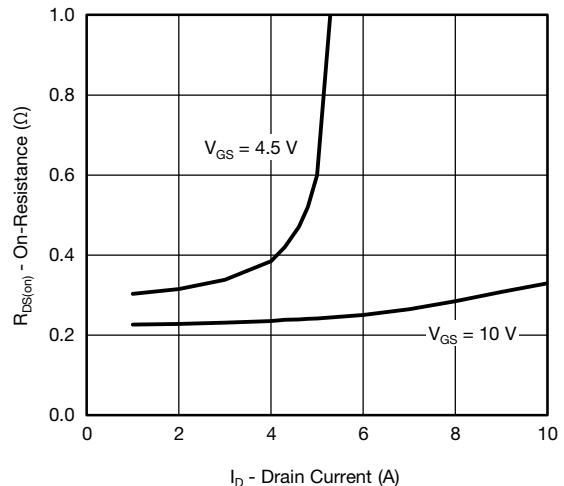

On-Resistance vs. Drain Current



TYPICAL CHARACTERISTICS (25 °C, unless otherwise noted)

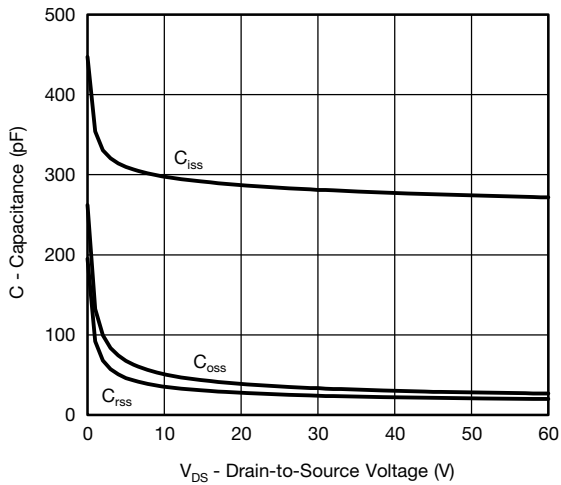

Capacitance

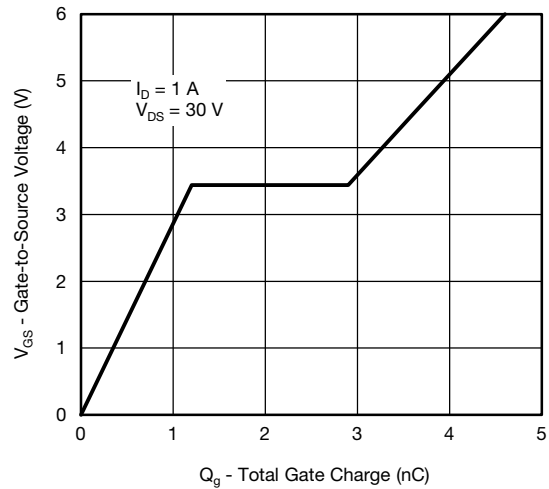

Gate Charge

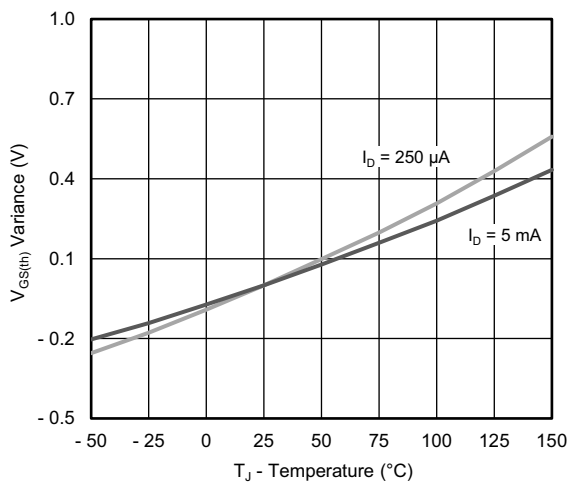

Threshold Voltage

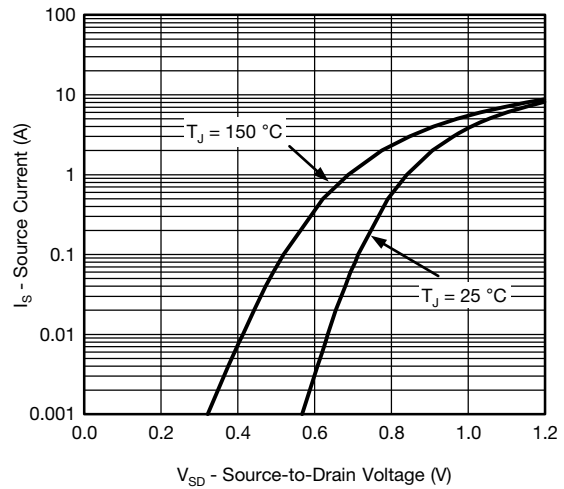

Source Drain Diode Forward Voltage

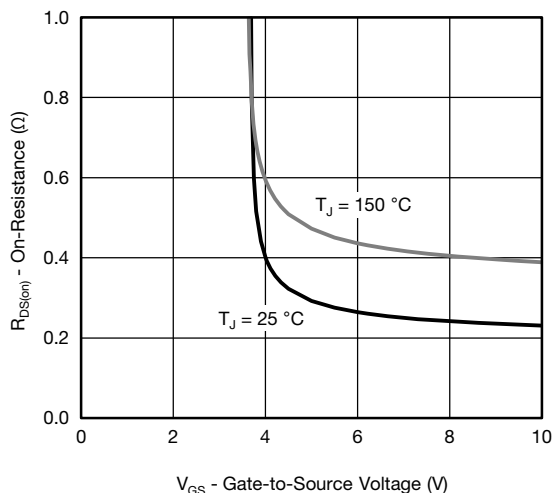

On-Resistance vs. Gate-to-Source Voltage

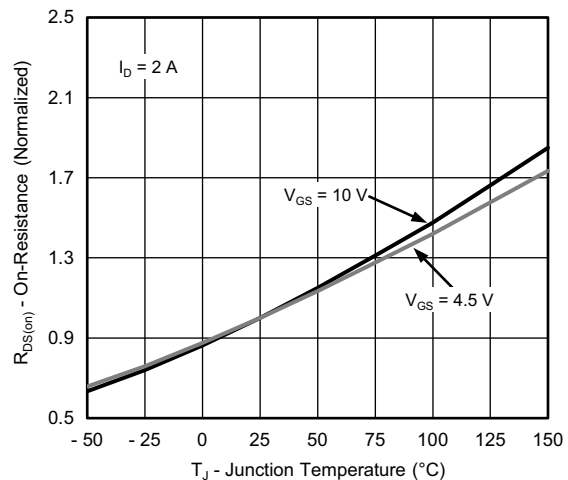

On-Resistance vs. Junction Temperature



TYPICAL CHARACTERISTICS ($T_A = 25\text{ }^\circ\text{C}$, unless otherwise noted)

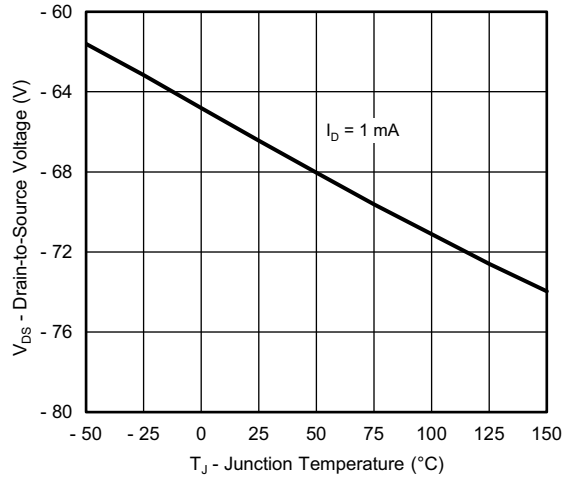

Drain Source Breakdown vs. Junction Temperature

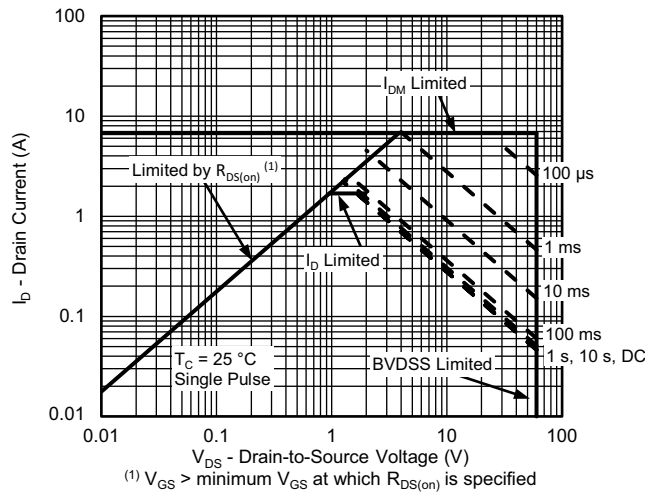

Safe Operating Area



THERMAL RATINGS ($T_A = 25\text{ }^\circ\text{C}$, unless otherwise noted)

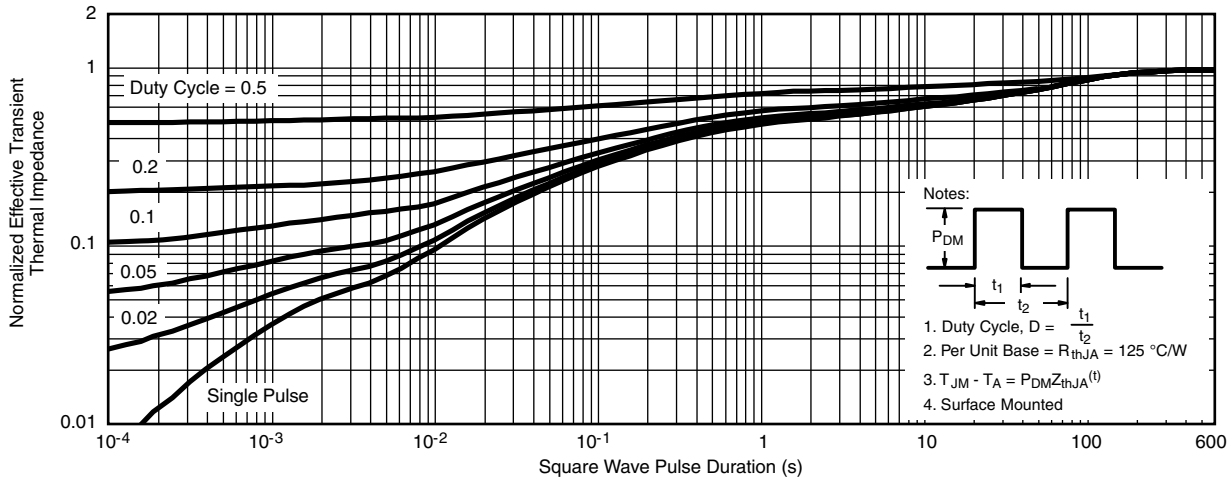

Normalized Thermal Transient Impedance, Junction-to-Ambient

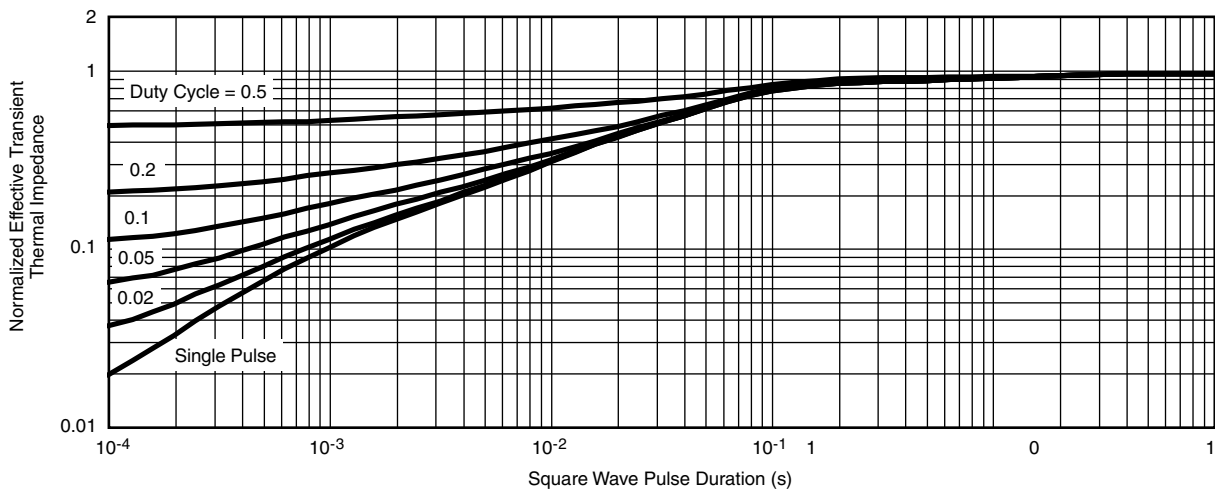

Normalized Thermal Transient Impedance, Junction-to-Foot

Note

- The characteristics shown in the two graphs
 - Normalized Transient Thermal Impedance Junction-to-Ambient ($25\text{ }^\circ\text{C}$)
 - Normalized Transient Thermal Impedance Junction-to-Foot ($25\text{ }^\circ\text{C}$)
 are given for general guidelines only to enable the user to get a “ball park” indication of part capabilities. The data are extracted from single pulse transient thermal impedance characteristics which are developed from empirical measurements. The latter is valid for the part mounted on printed circuit board - FR4, size 1" x 1" x 0.062", double sided with 2 oz. copper, 100 % on both sides. The part capabilities can widely vary depending on actual application parameters and operating conditions

Vishay Siliconix maintains worldwide manufacturing capability. Products may be manufactured at one of several qualified locations. Reliability data for Silicon Technology and Package Reliability represent a composite of all qualified locations. For related documents such as package / tape drawings, part marking, and reliability data, see www.vishay.com/ppg?68494.

SC-70: 6-LEADS

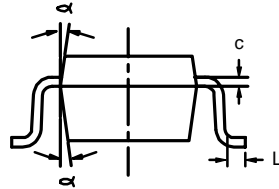

| Dim | MILLIMETERS | | | INCHES | | |
|----------------|-------------|------|------|----------|-------|-------|
| | Min | Nom | Max | Min | Nom | Max |
| A | 0.90 | - | 1.10 | 0.035 | - | 0.043 |
| A ₁ | - | - | 0.10 | - | - | 0.004 |
| A ₂ | 0.80 | - | 1.00 | 0.031 | - | 0.039 |
| b | 0.15 | - | 0.30 | 0.006 | - | 0.012 |
| c | 0.10 | - | 0.25 | 0.004 | - | 0.010 |
| D | 1.80 | 2.00 | 2.20 | 0.071 | 0.079 | 0.087 |
| E | 1.80 | 2.10 | 2.40 | 0.071 | 0.083 | 0.094 |
| E ₁ | 1.15 | 1.25 | 1.35 | 0.045 | 0.049 | 0.053 |
| e | 0.65BSC | | | 0.026BSC | | |
| e ₁ | 1.20 | 1.30 | 1.40 | 0.047 | 0.051 | 0.055 |
| L | 0.10 | 0.20 | 0.30 | 0.004 | 0.008 | 0.012 |
| α | 7°Nom | | | 7°Nom | | |

ECN: S-03946—Rev. B, 09-Jul-01
DWG: 5550

RECOMMENDED MINIMUM PADS FOR SC-70: 6-Lead

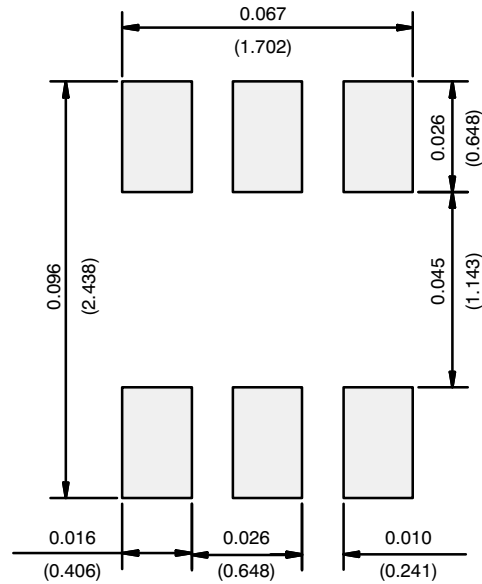

Recommended Minimum Pads
Dimensions in Inches/(mm)

[Return to Index](#)



Disclaimer

ALL PRODUCT, PRODUCT SPECIFICATIONS AND DATA ARE SUBJECT TO CHANGE WITHOUT NOTICE TO IMPROVE RELIABILITY, FUNCTION OR DESIGN OR OTHERWISE.

Vishay Intertechnology, Inc., its affiliates, agents, and employees, and all persons acting on its or their behalf (collectively, "Vishay"), disclaim any and all liability for any errors, inaccuracies or incompleteness contained in any datasheet or in any other disclosure relating to any product.

Vishay makes no warranty, representation or guarantee regarding the suitability of the products for any particular purpose or the continuing production of any product. To the maximum extent permitted by applicable law, Vishay disclaims (i) any and all liability arising out of the application or use of any product, (ii) any and all liability, including without limitation special, consequential or incidental damages, and (iii) any and all implied warranties, including warranties of fitness for particular purpose, non-infringement and merchantability.

Statements regarding the suitability of products for certain types of applications are based on Vishay's knowledge of typical requirements that are often placed on Vishay products in generic applications. Such statements are not binding statements about the suitability of products for a particular application. It is the customer's responsibility to validate that a particular product with the properties described in the product specification is suitable for use in a particular application. Parameters provided in datasheets and / or specifications may vary in different applications and performance may vary over time. All operating parameters, including typical parameters, must be validated for each customer application by the customer's technical experts. Product specifications do not expand or otherwise modify Vishay's terms and conditions of purchase, including but not limited to the warranty expressed therein.

Except as expressly indicated in writing, Vishay products are not designed for use in medical, life-saving, or life-sustaining applications or for any other application in which the failure of the Vishay product could result in personal injury or death. Customers using or selling Vishay products not expressly indicated for use in such applications do so at their own risk. Please contact authorized Vishay personnel to obtain written terms and conditions regarding products designed for such applications.

No license, express or implied, by estoppel or otherwise, to any intellectual property rights is granted by this document or by any conduct of Vishay. Product names and markings noted herein may be trademarks of their respective owners.