



### Product Description

The SPF5043Z is a high performance pHEMT MMIC LNA designed for operation from 50MHz to 4000MHz. The on-chip active bias network provides stable current over temperature and process threshold voltage variations. The SPF5043Z offers ultra-low noise figure and high linearity performance in a gain block configuration. Its single-supply operation and integrated matching networks make implementation remarkably simple. The high maximum input power specification makes it ideal for high dynamic range receivers.

**Optimum Technology Matching® Applied**

- GaAs HBT
- GaAs MESFET
- InGaP HBT
- SiGe BiCMOS
- Si BiCMOS
- SiGe HBT
- GaAs pHEMT
- Si CMOS
- Si BJT
- GaN HEMT
- InP HBT
- RF MEMS
- LDMOS

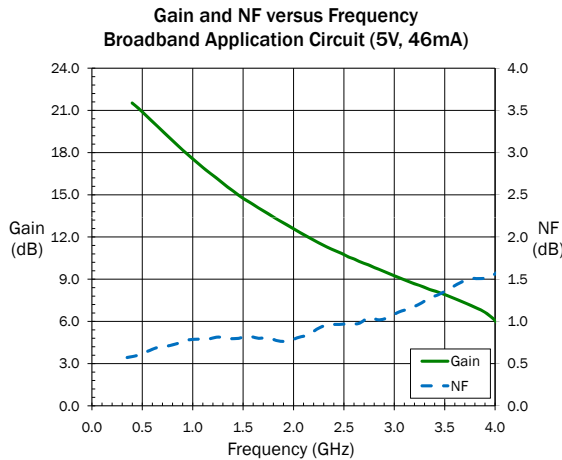

### Features

- Ultra-Low Noise  
Figure=0.8dB at 900MHz
- Gain = 18.2dB at 900MHz
- High Linearity: OIP3 = 35dBm at 1900MHz
- P<sub>1dB</sub> = 22.7 dBm at 1900MHz
- Single-Supply Operation:  
5V at I<sub>DQ</sub> = 46mA
- Flexible Biasing Options: 3V to 5V, Adjustable Current
- Broadband Internal Matching

### Applications

- Cellular, PCS, W-CDMA, ISM, and LTE
- Low Noise, High Linearity Gain Block Applications

Parameter	Specification			Unit	Condition
	Min.	Typ.	Max.		
Small Signal Power Gain	16.7	18.2	19.7	dB	0.9GHz
	11.4	12.9	14.4	dB	1.96GHz
Output Power at 1dB Compression	17.4	22.6		dBm	0.9GHz
		22.7		dBm	1.9GHz
Output Third Order Intercept Point	30.0	33.0		dBm	0.9GHz
		35.0		dBm	1.9GHz
Noise Figure		0.80	1.0	dB	0.9GHz
		0.80		dB	1.9GHz
Input Return Loss	13.0	16.0		dB	0.9GHz
		17.5		dB	1.9GHz
Output Return Loss	14.5	17.5		dB	0.9GHz
		16.5		dB	1.9GHz
Reverse Isolation		23.5		dB	0.9GHz
		19.0		dB	1.9GHz
Device Operating Voltage		5	5.25	V	
Device Operating Current (Quiescent)	28	46	54	mA	
Thermal Resistance (junction to lead)		125		°C/W	junction to lead

Test Conditions: V<sub>D</sub>=5V, I<sub>DQ</sub>=46mA, OIP<sub>3</sub> Tone Spacing=1MHz, P<sub>OUT</sub> per tone=-5dBm, Z<sub>S</sub>=Z<sub>L</sub>=50Ω, 25°C, Broadband Application Circuit

## Absolute Maximum Ratings

Parameter	Rating	Unit
Max Device Current ( $I_D$ )	100	mA
Max Device Voltage ( $V_D$ )	5.5	V
Max RF Input Power	25	dBm
Max Dissipated Power	330	mW
Max Junction Temperature ( $T_J$ )	150	°C
Operating Temperature Range ( $T_L$ )	-40 to + 85	°C
Max Storage Temperature	-65 to +150	°C
ESD Rating - Human Body Model (HBM)	Class 1A	
Moisture Sensitivity (MSL)	MSL 1	



**Caution!** ESD sensitive device.

Exceeding any one or a combination of the Absolute Maximum Rating conditions may cause permanent damage to the device. Extended application of Absolute Maximum Rating conditions to the device may reduce device reliability. Specified typical performance or functional operation of the device under Absolute Maximum Rating conditions is not implied.

The information in this publication is believed to be accurate and reliable. However, no responsibility is assumed by RF Micro Devices, Inc. ("RFMD") for its use, nor for any infringement of patents, or other rights of third parties, resulting from its use. No license is granted by implication or otherwise under any patent or patent rights of RFMD. RFMD reserves the right to change component circuitry, recommended application circuitry and specifications at any time without prior notice.



RFMD Green: RoHS compliant per EU Directive 2002/95/EC, halogen free per IEC 61249-2-21, < 1000ppm each of antimony trioxide in polymeric materials and red phosphorus as a flame retardant, and <2% antimony in solder.

- Notes: 1. The maximum ratings must all be met simultaneously.  
 2.  $P_{DISS} = P_{DC} + PRF_{IN} - PRF_{OUT}$   
 3.  $T_J = T_L + P_{DISS} * R_{TH}$

Operation beyond any of these limits may cause permanent damage.

### Typical RF Performance - Broadband Application Circuit with $V_D=5V$ , $I_D=46mA$

Parameter	Unit	0.1 GHz*	0.4 GHz	0.9 GHz	1.5 GHz	1.9 GHz	2.2 GHz	2.5 GHz	3.5 GHz	3.8 GHz
Small Signal Gain	dB	23.5	21.6	18.2	14.8	13.1	11.9	10.8	8.0	7.0
Noise Figure	dB	0.65	0.61	0.74	0.82	0.78	0.84	0.96	1.34	1.49
Output IP3	dBm	30.5	31.0	33.0	34.5	35.0	35.5	36.5	38.5	37.5
Output P1dB	dBm	na	22.5	22.6	22.7	22.7	23.0	22.8	23.1	22.8
Input Return Loss	dB	-13.0	-12.5	-15.5	-18.0	-17.5	-17.0	-16.0	-11.5	-10.5
Output Return Loss	dB	-22.0	-17.5	-20.0	-18.0	-17.0	-17.0	-16.5	-16.0	-13.5
Reverse Isolation	dB	-27.0	-26.0	-23.5	-20.5	-19.0	-18.0	-17.5	-15.0	-15.0

Test Conditions:  $V_D=5V$ ,  $I_{DQ}=46mA$ , OIP<sub>3</sub> Tone Spacing=1MHz, P<sub>OUT</sub> per tone=0dBm,  $T_L=25^\circ C$ ,  $Z_S=Z_L=50\Omega$ , \*Bias Tee Data @ 100MHz

### Typical RF Performance - Broadband Application Circuit with $V_D=3V$ , $I_D=25mA$

Parameter	Unit	0.1 GHz*	0.4 GHz	0.9 GHz	1.5 GHz	1.9 GHz	2.2 GHz	2.5 GHz	3.5 GHz	3.8 GHz
Small Signal Gain	dB	22.6	20.9	17.7	14.4	12.7	11.5	10.5	7.6	6.7
Noise Figure	dB	0.60	0.61	0.73	0.82	0.78	0.85	0.93	1.28	1.48
Output IP3	dBm	26.5	27.0	28.5	30.0	30.5	30.5	32.0	33.5	33.0
Output P1dB	dBm	na	19.3	19.5	19.9	20.0	20.3	20.2	20.3	19.7
Input Return Loss	dB	-10.5	-11.0	-14.0	-16.5	-16.5	-16.0	-14.5	-10.5	-9.5
Output Return Loss	dB	-21.0	-21.5	-28.5	-24.5	-22.5	-22.5	-22.5	-20.0	-15.5
Reverse Isolation	dB	-26.0	-25.5	-22.5	-20.0	-18.0	-17.5	-16.5	-14.5	-14.0

Test Conditions:  $V_D=3V$ ,  $I_{DQ}=25mA$ , OIP<sub>3</sub> Tone Spacing=1MHz, P<sub>OUT</sub> per tone=0dBm,  $T_L=25^\circ C$ ,  $Z_S=Z_L=50\Omega$ , \*Bias Tee Data @ 100MHz

RFMD + TriQuint = Qorvo

Typical RF Performance - Broadband Application Circuit with  $V_D=5V$ ,  $I_D=46mA$

NF versus Frequency

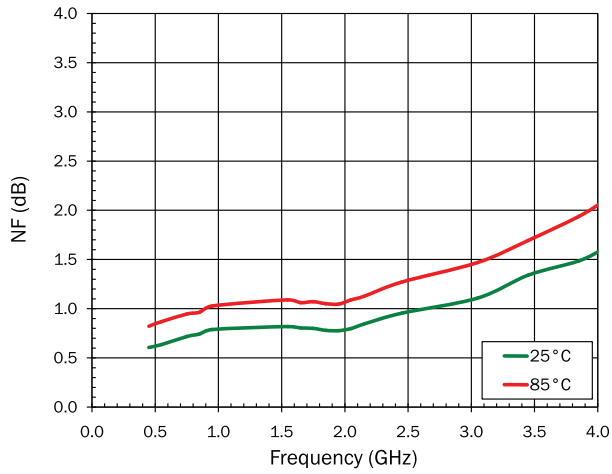

OIP3 vs. Frequency (-5dBm/tone, 1MHz spacing)

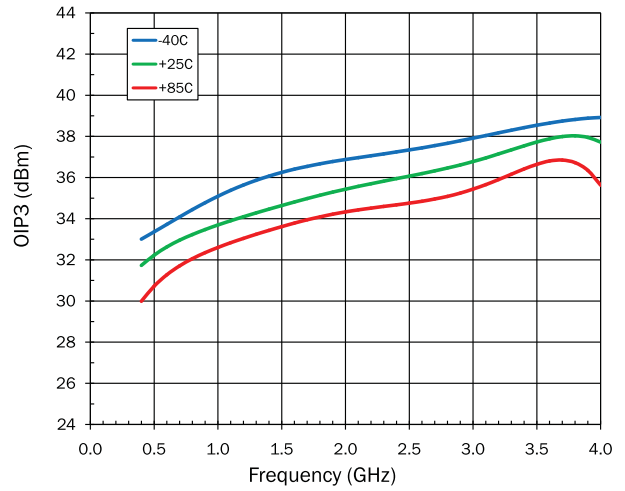

P1dB versus Frequency

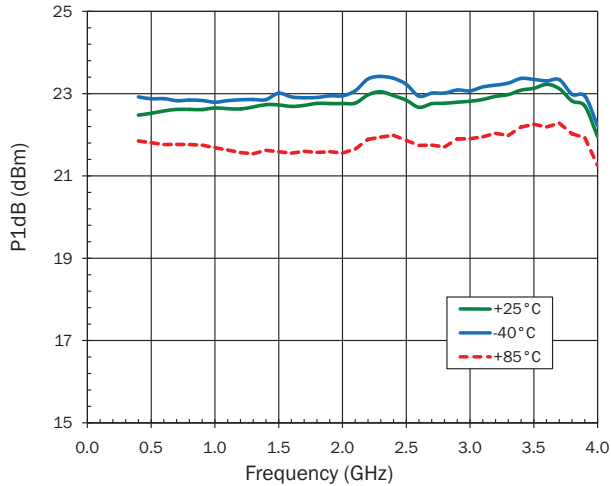

Device Current versus Voltage

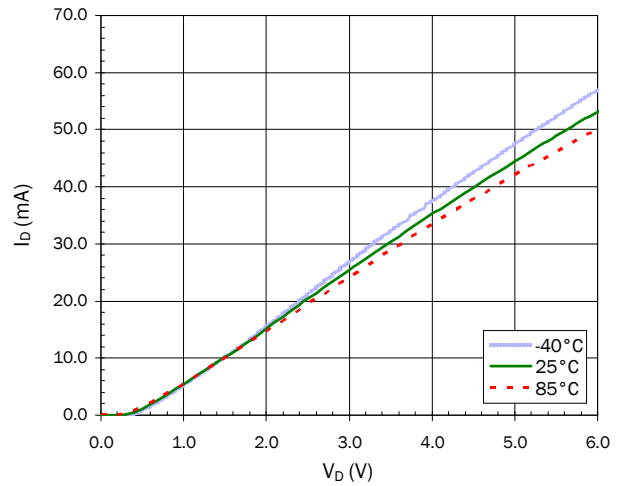

Typical RF Performance - Broadband Application Circuit with  $V_D=5V$ ,  $I_D=46mA$

### S11 versus Frequency

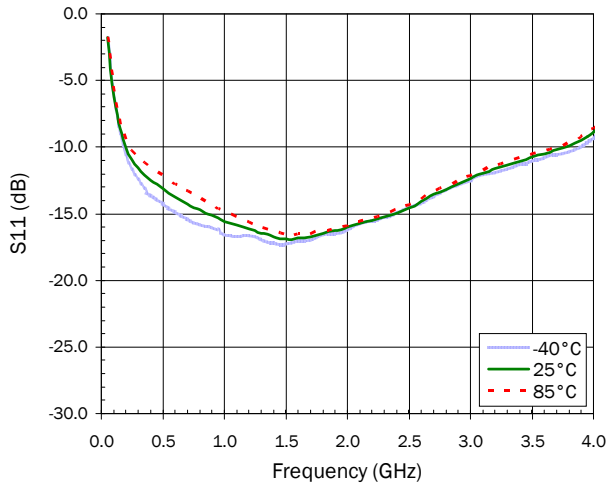

### S21 versus Frequency

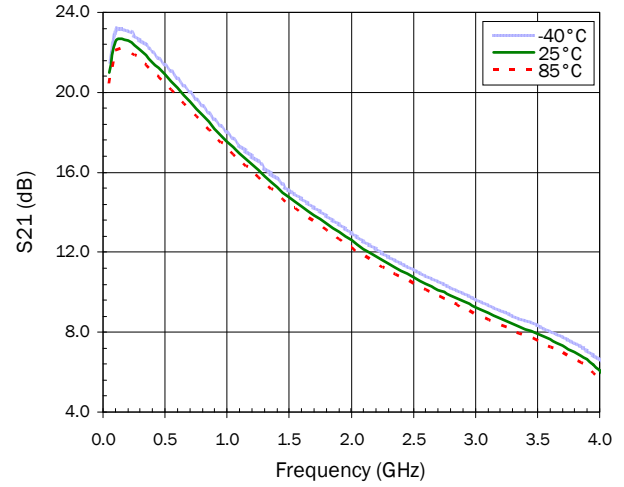

### S12 versus Frequency

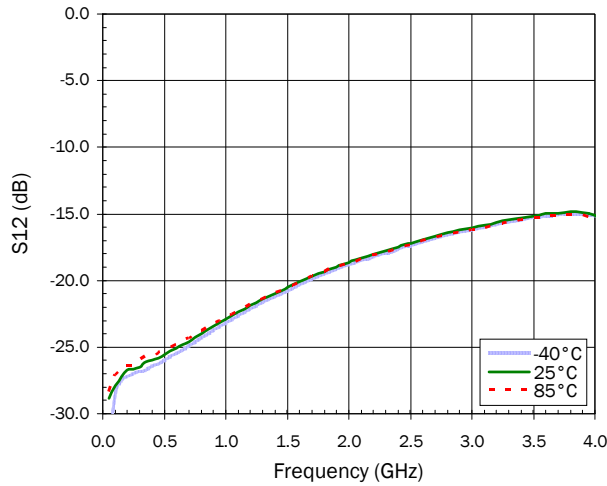

### S22 versus Frequency

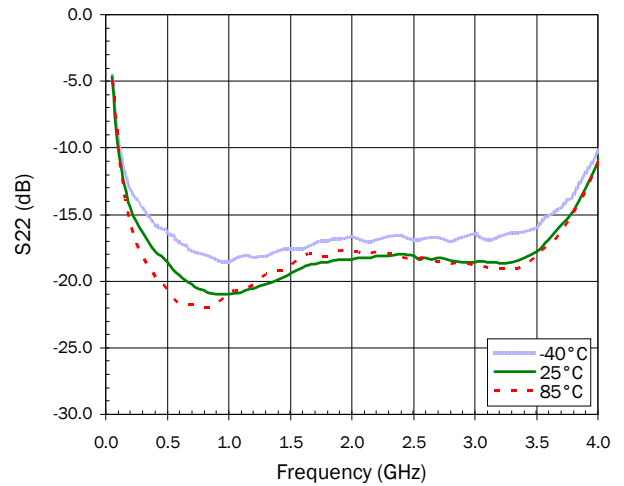

Typical RF Performance - Broadband Application Circuit with  $V_D=5V$ ,  $I_D=46mA$

OIP3 versus Power Out (Vd = 5V, 900MHz)

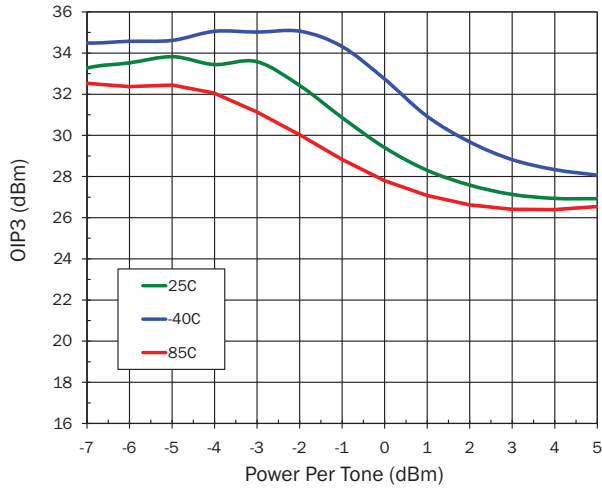

OIP3 versus Power Out (Vd = 5V, 25C)

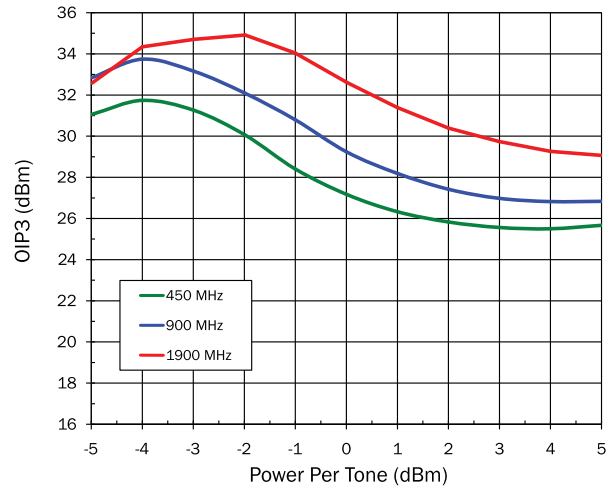

Output Power versus Input Power (Vd=5V, 900 MHz)

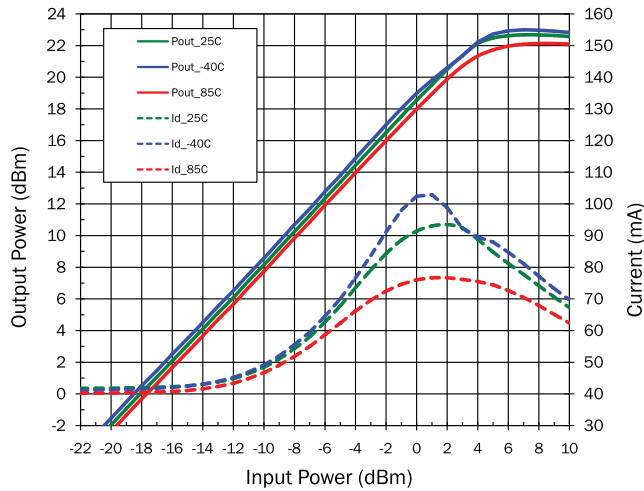

Output Power versus Input Power (Vd=5V)

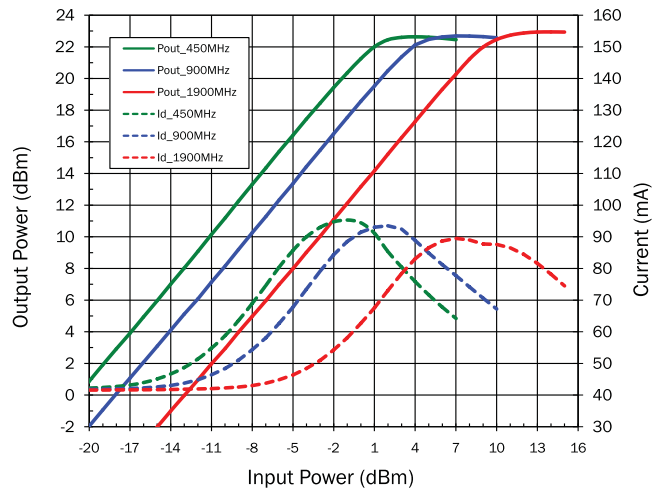

Typical RF Performance - Broadband Application Circuit with  $V_D=3V$ ,  $I_D=25mA$

NF versus Frequency

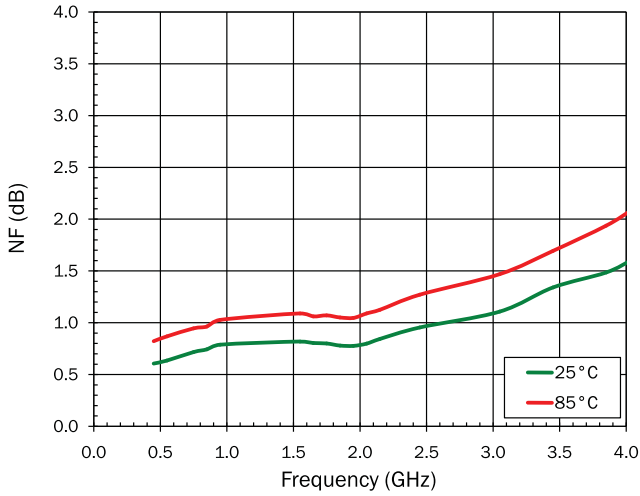

OIP3 vs. Frequency (-5dBm/tone, 1MHz spacing)

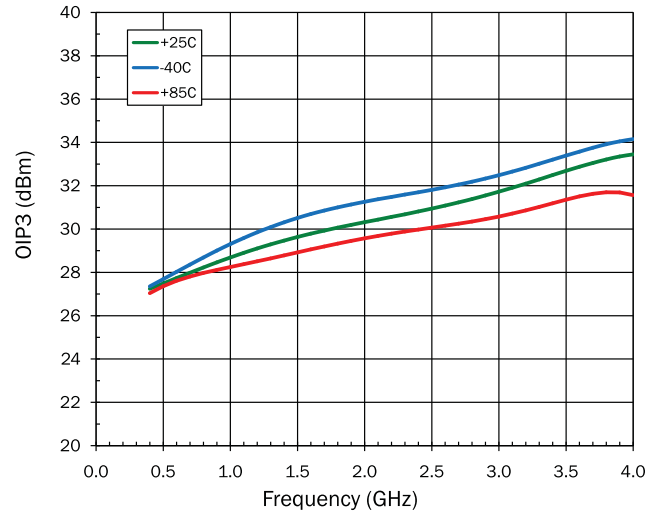

P1dB versus Frequency

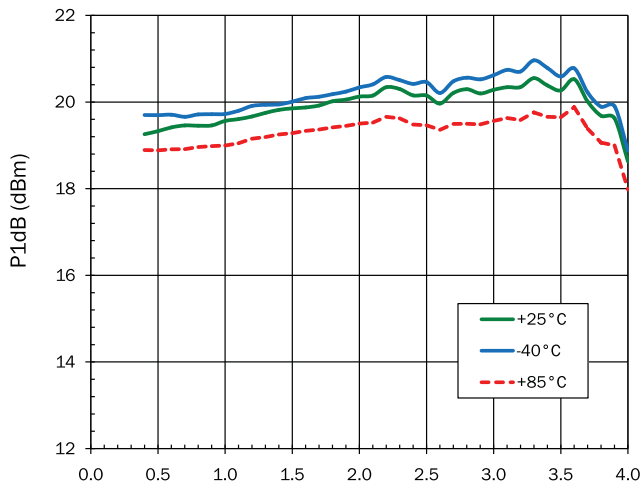

Typical RF Performance - Broadband Application Circuit with  $V_D=3V$ ,  $I_D=25mA$

**S11 versus Frequency**

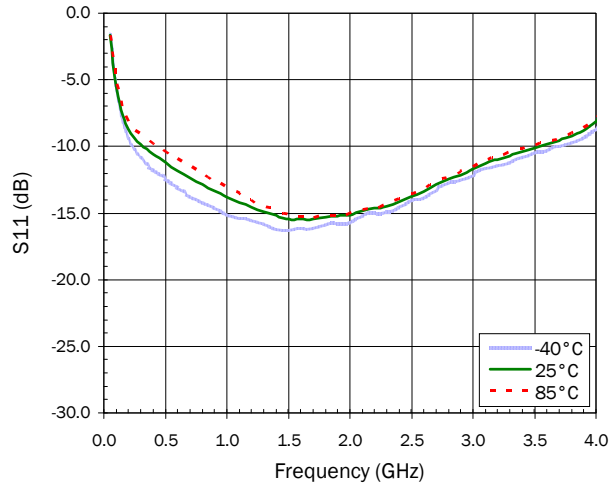

**S21 versus Frequency**

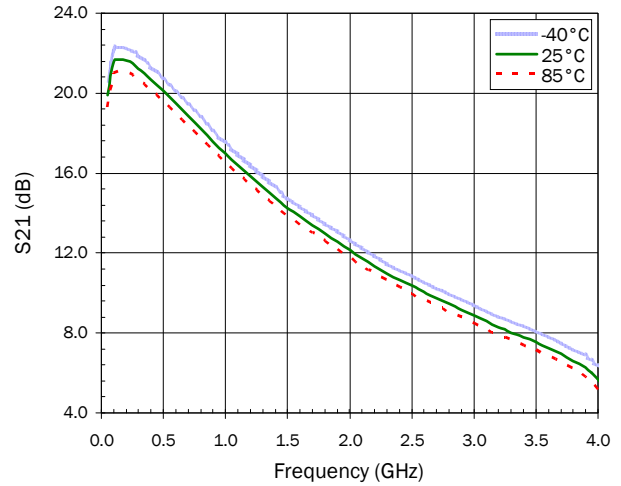

**S12 versus Frequency**

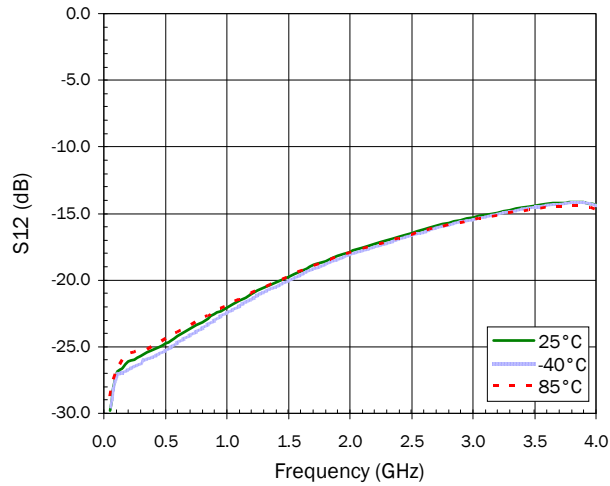

**S22 versus Frequency**

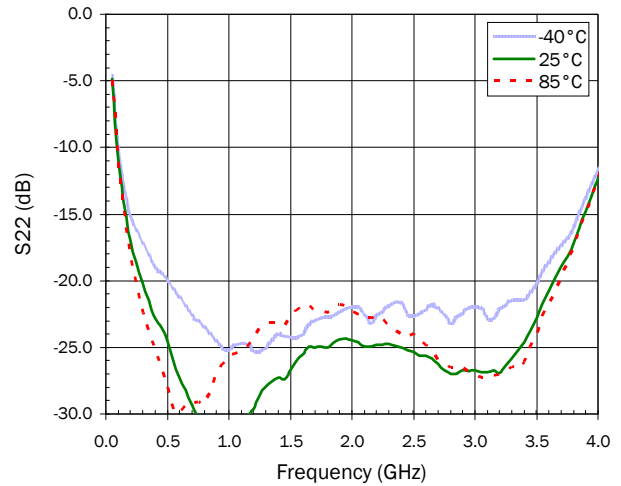

Typical RF Performance - Broadband Application Circuit with  $V_D=3V$ ,  $I_D=25mA$   
 OIP3 versus Power Out ( $V_d = 3V$ , 900MHz)

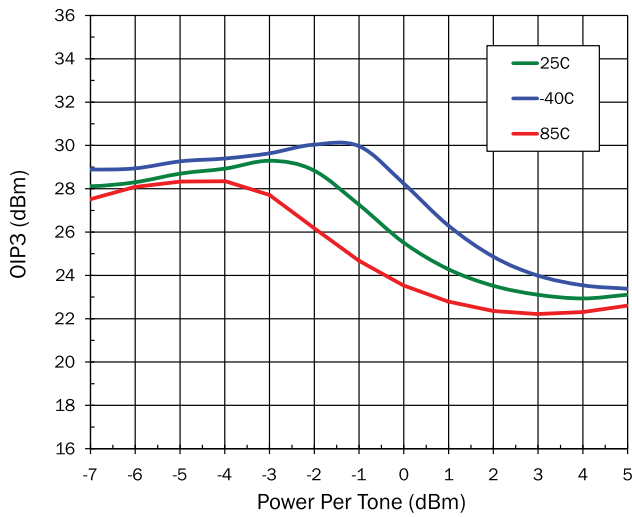

OIP3 versus Power Out ( $V_d = 3V$ , 25C)

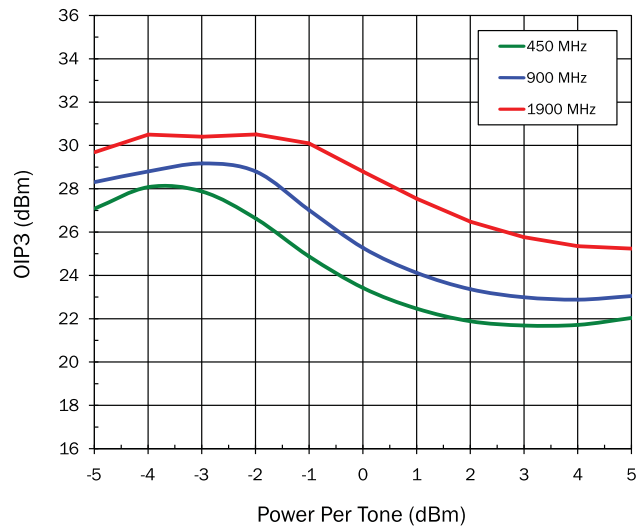

Output Power versus Input Power ( $V_d=3V$ , 900 MHz)

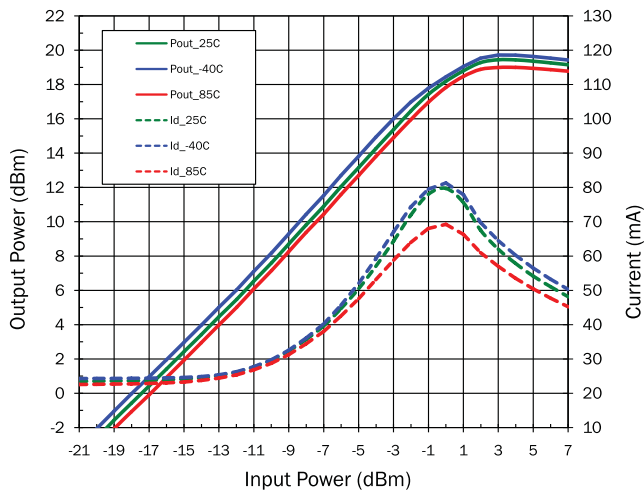

Output Power versus Input Power ( $V_d=3V$ )

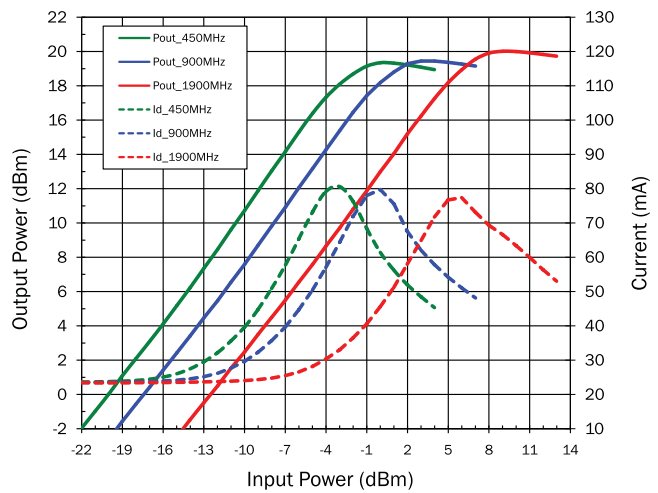



De-embedded Device S-parameters (Bias Tee Data)

Gmax versus Frequency (5V,46mA)

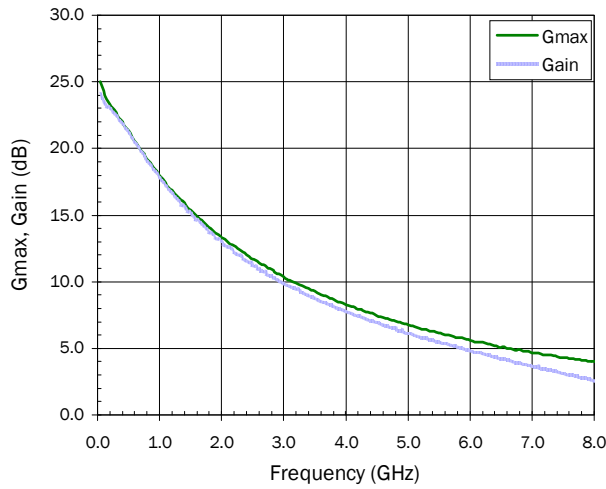

S11 versus Frequency (5V 46mA)

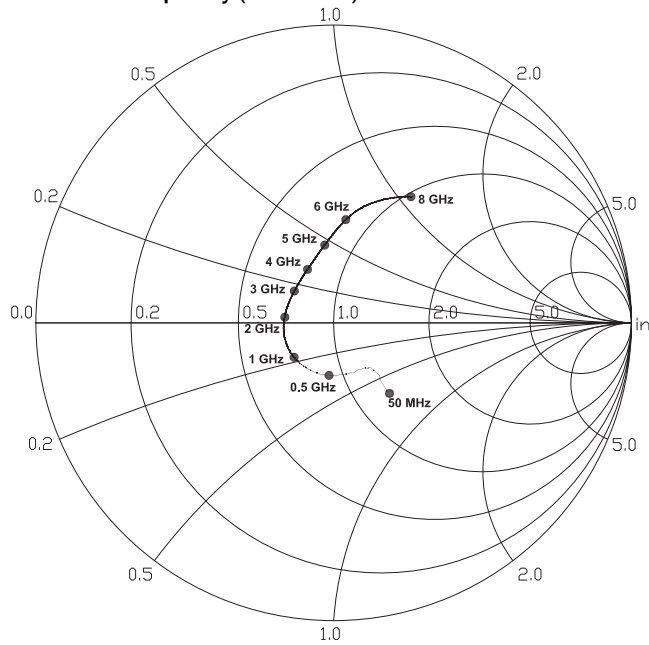

S22 versus Frequency (5V 46mA)

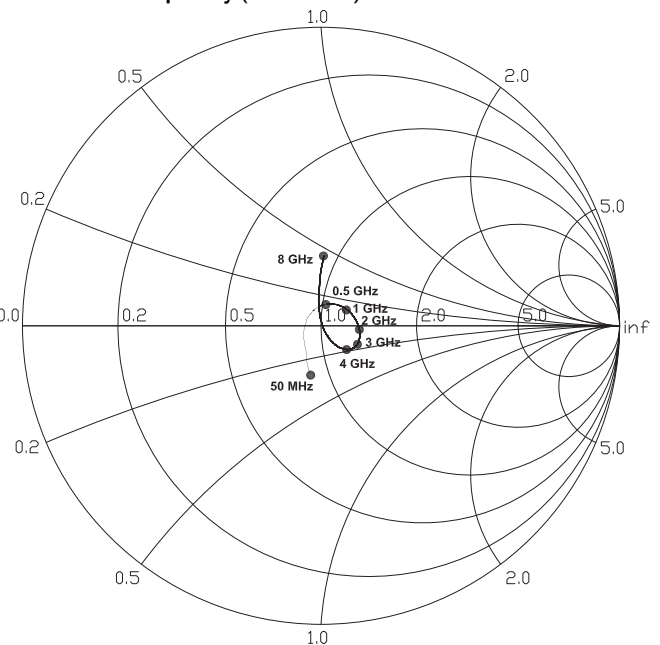

Gmax versus Frequency (3V, 25mA)

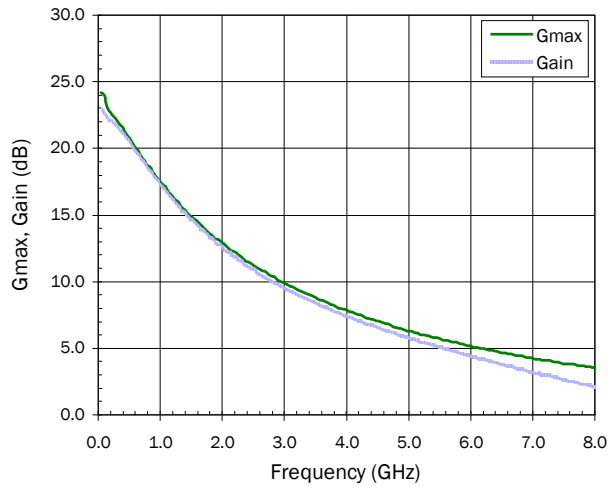

S11 versus Frequency (3V 25mA)

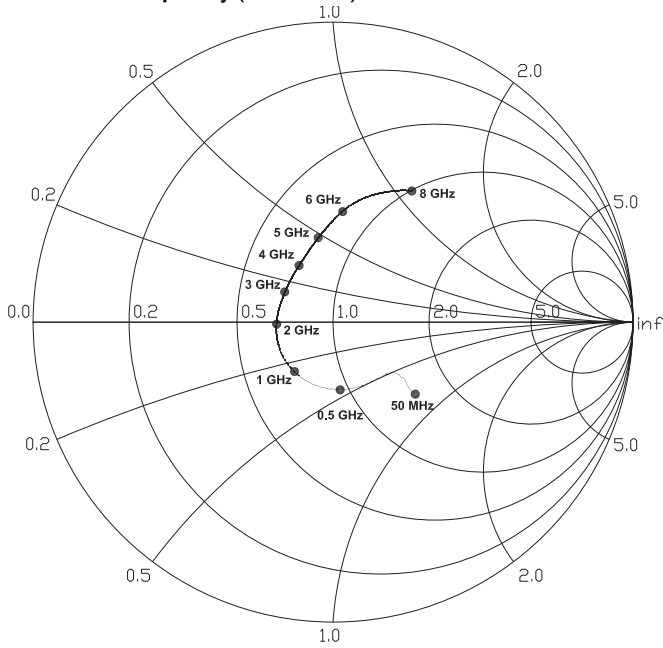

S22 versus Frequency (3V 25mA)

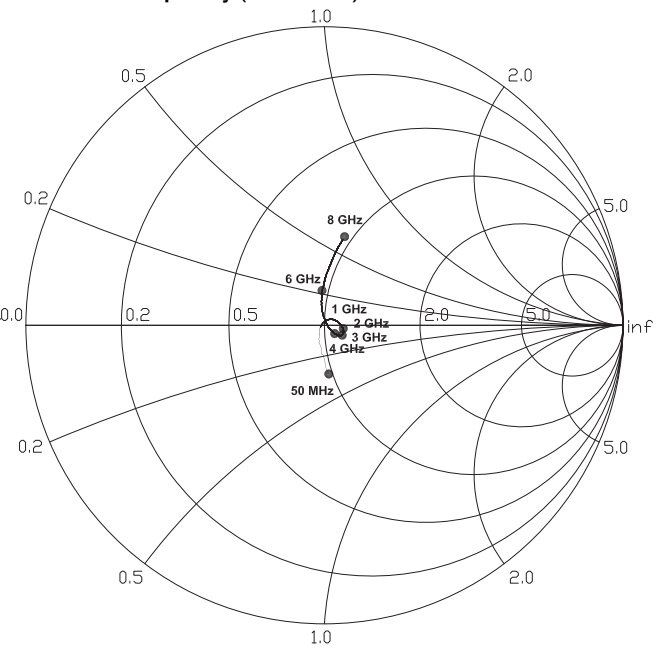

**Evaluation Board Layout**

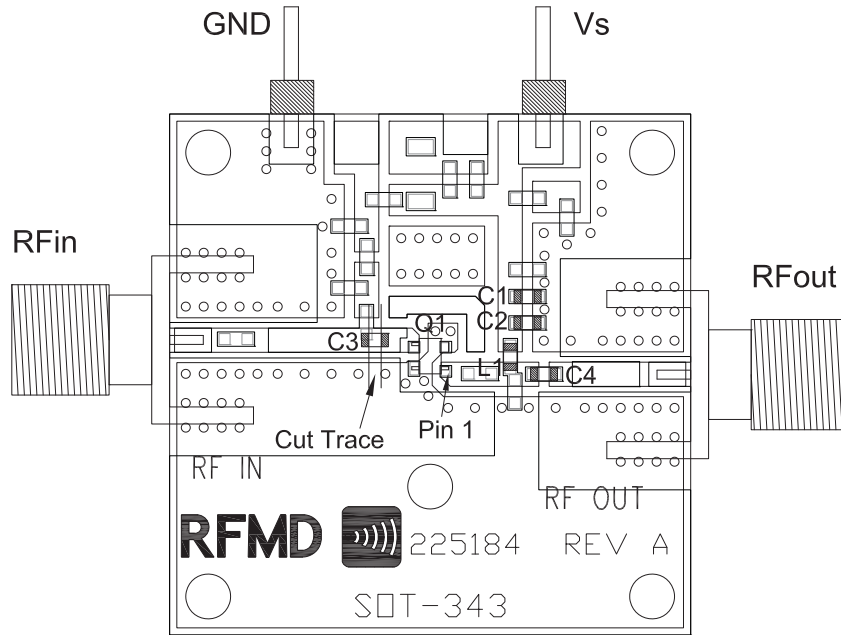

**Bill of Materials (SPF5043Z, 400MHz to 3000MHz)**

C1	TAJB104KLRf, Rohm, 0.1uF
C2	MCH185A101JK, Rohm, 100pF
C3	MCH185A101JK, Rohm, 100pF
C4	MCH185A101JK, Rohm, 100pF
L1	LL1608-FSR10J, Toko, 100nH

**Application Schematic**

(400MHz to 3000MHz)

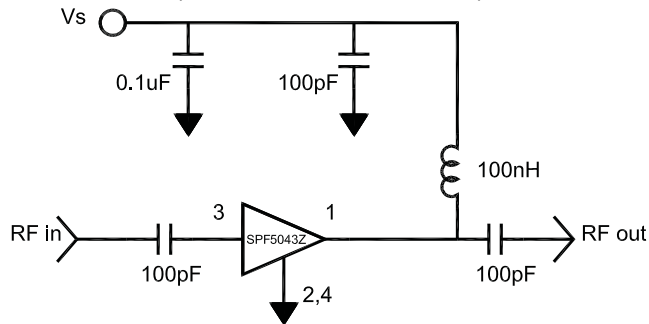

## Pin Names and Description

Pin	Function	Description
1	RF OUT/BIAS	RF Output Pin. This Pin is DC Coupled and Matched to 50Ω. An external DC block is required.
2	GND	Connection to ground.
3	RF IN	RF Input Pin. This Pin is DC Coupled and Matched to 50Ω. An external DC block is required.
4	GND	Connection to ground.

## Suggested Pad Layout

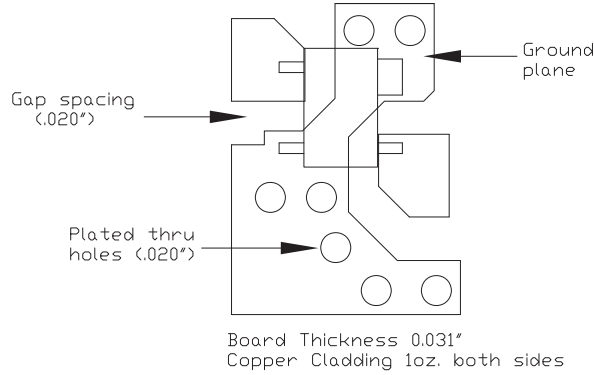

## Package Drawing

Dimensions in millimeters (inches)

Refer to drawing posted at [www.rfmd.com](http://www.rfmd.com) for tolerances.

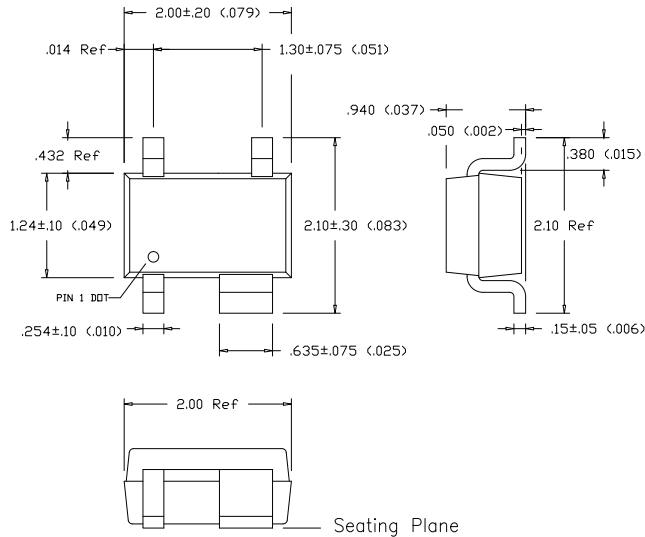

### Notes:

1. Lead Base Metal - Copper  $\square$ lin 194
2. Lead Finish - 100% Matte Sn - .010 (.0004) min thk

## Part Identification Marking - Trace Code Only

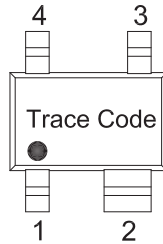

## Ordering Information

Ordering Code	Description
SPF5043Z	7" Reel with 3000 pieces
SPF5043ZSQ	Sample bag with 25 pieces
SPF5043ZSR	7" Reel with 100 pieces
SPF5043ZPCK1	400MHz to 3000MHz PCBA with 5-piece sample bag