

HEAT SINK HS103

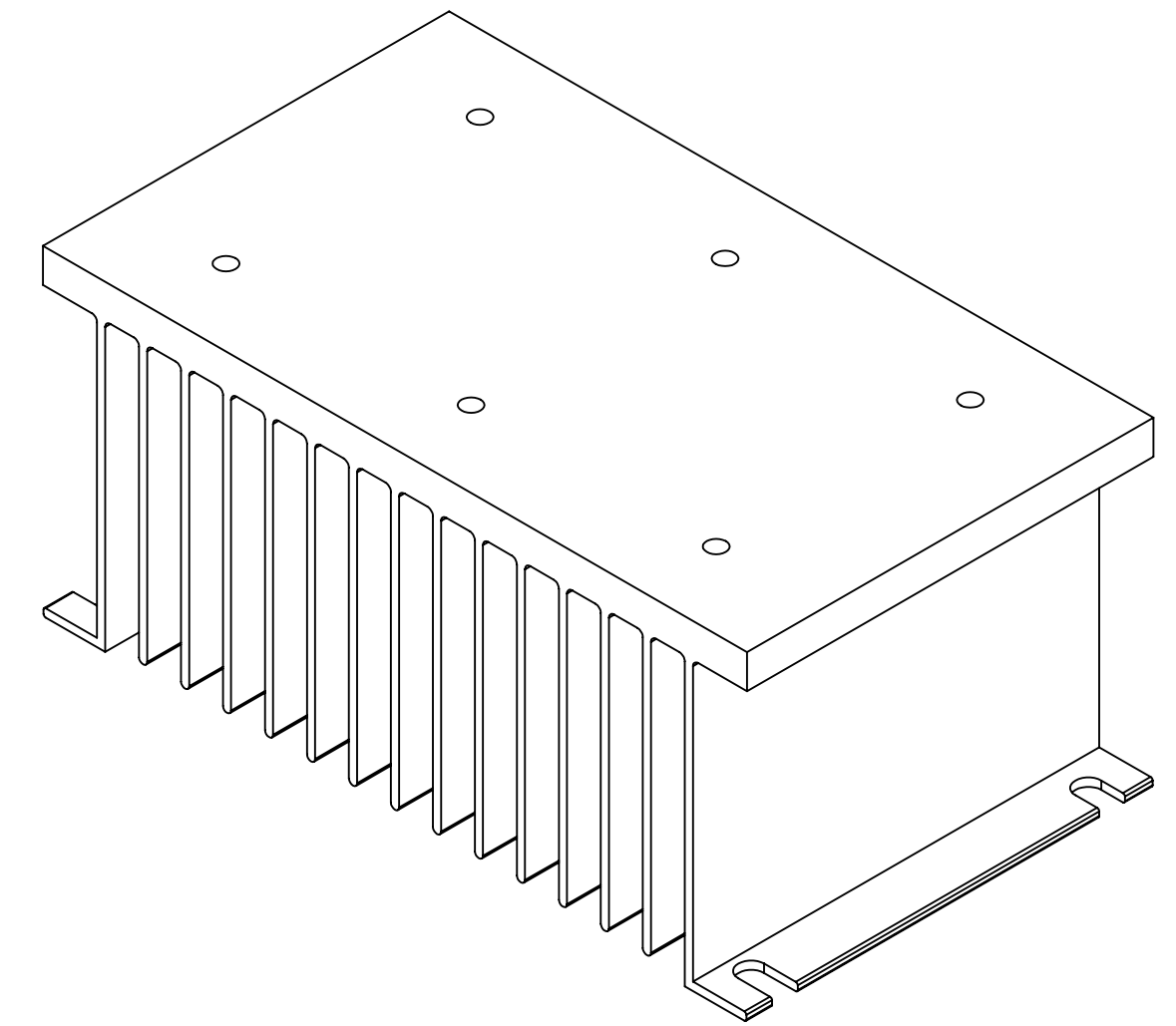
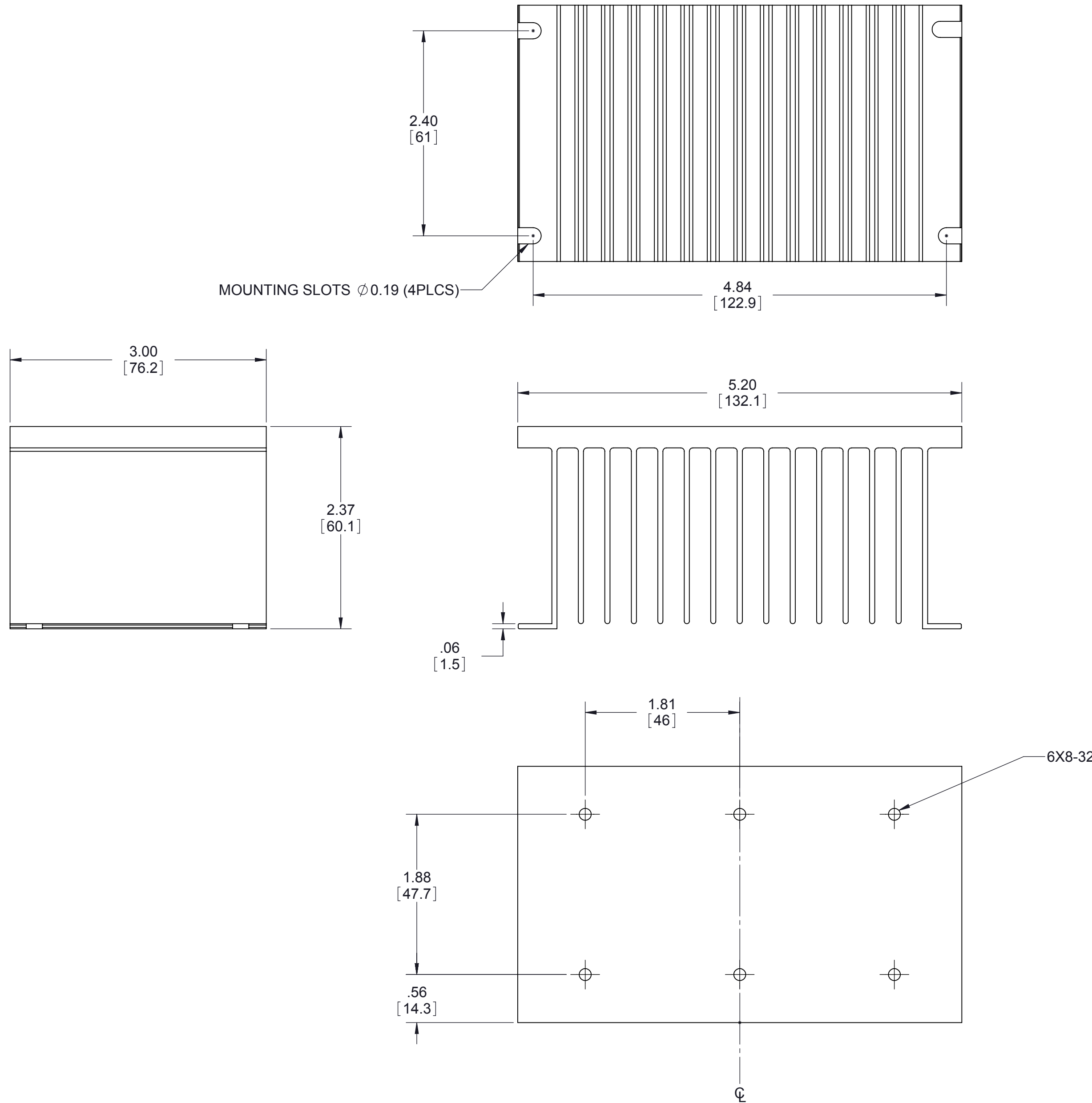

Tolerances: ± 0.02 in / 0.5 mm. All dimensions are in: inches [millimeters]