

PART No. 1485C24

for more information visit
www.hammfg.com

Data subject to change without notice

Isometric drawing Not to Scale

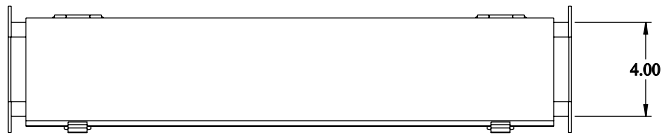
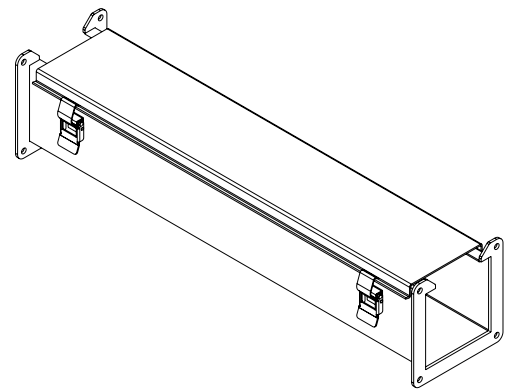

TOP VIEW

ISOMETRIC VIEW

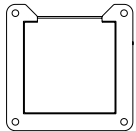

SIDE VIEW

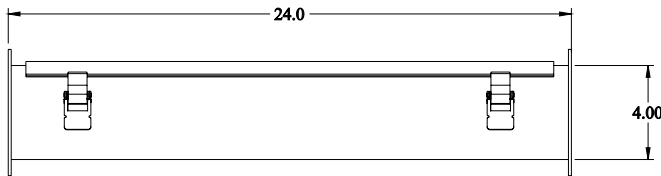

FRONT VIEW

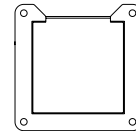

SIDE VIEW



BOTTOM VIEW