

MAX11321–MAX11328

1Msps, 10-/12-Bit, 4-/8-/16-Channel ADCs with Post-Mux External Signal Conditioning Access

General Description

The MAX11321–MAX11328 are 12-/10-bit with external reference and 500kHz, full-linear-bandwidth, high-speed, low-power, serial-output successive approximation register (SAR) analog-to-digital converters (ADCs). The MAX11321–MAX11328 provide external access to the output of the integrated mux and ADC input, to simplify conditioning. The MAX11321–MAX11328 include both internal and external clock modes. These devices feature scan mode in both internal and external clock modes. The internal clock mode features internal averaging to increase SNR. The external clock mode features the SampleSet™ technology, a user-programmable analog input channel sequencer. The SampleSet approach provides greater sequencing flexibility for multichannel applications while alleviating significant microcontroller or DSP (controlling unit) communication overhead.

External pins provide access to the output of the multiplexer and ADC inputs to simplify multichannel signal conditioning. The internal clock mode features an integrated FIFO allowing data to be sampled at high speeds and then held for readout at any time or at a lower clock rate. Internal averaging is also supported in internal clock mode improving SNR for noisy input signals. The devices feature analog input channels that can be configured to be single-ended inputs, fully differential pairs, or pseudo-differential inputs with respect to one common input. The MAX11321–MAX11328 operate from a 2.35V to 3.6V supply and consume only 5.4mW at 1Msps.

The MAX11321–MAX11328 include AutoShutdown™, fast wake-up, and a high-speed 3-wire serial interface. The devices feature full power-down mode for optimal power management. The 48MHz, 3-wire serial interface directly connects to SPI, QSPI™, and MICROWIRE® devices without external logic.

Excellent dynamic performance, low voltage, low power, ease of use, and small package size make these converters ideal for portable battery-powered data-acquisition applications, and for other applications that demand low power consumption and small space.

The MAX11321–MAX11328 are available in 32-pin, 5mm x 5mm, TQFN packages and operate over the -40°C to +125°C temperature range.

SampleSet and AutoShutdown are trademarks of Maxim Integrated Products, Inc.

QSPI is a trademark of Motorola, Inc.

MICROWIRE is a registered trademark of National Semiconductor Corp.

Ordering Information appears at end of data sheet.

For pricing, delivery, and ordering information, please contact Maxim Direct at 1-888-629-4642, or visit Maxim's website at www.maximintegrated.com.

Benefits and Features

- ◆ Scan Modes, Internal Averaging, and Internal Clock
- ◆ 16-Entry First-In/First-Out (FIFO)
- ◆ SampleSet: User-Defined Channel Sequence with Maximum Length of 256
- ◆ Input Pins
 - ◇ Any Combination of Single-Ended, Differential and Pseudo-Differential Pairs Allowed
- ◆ Analog Multiplexer with True Differential Track/Hold
 - ◇ 16-/8-/4-Channel Single-Ended
 - ◇ 12-/8-/4-Channel Fully-Differential Pairs
 - ◇ 15-/8-/4-Channel Pseudo-Differential Relative to a Common Input
- ◆ Externally Accessible Multiplex Output and ADC Input
- ◆ Two Software-Selectable Bipolar Input Ranges
 - ◇ $\pm V_{REF+}/2$, $\pm V_{REF+}$
- ◆ Flexible Input Configuration Across All Channels
- ◆ High Accuracy
 - ◇ ± 1 LSB INL, ± 1 LSB DNL, No Missing Codes
- ◆ 70dB SINAD Guaranteed at 100kHz Input Frequency
- ◆ 1.5V to 3.6V Digital I/O Supply Voltage
- ◆ 2.35V to 3.6V Supply Voltage
- ◆ Extended Battery Life for Portable Applications
 - ◇ 5.4mW at 1Msps with 3V Supplies
 - ◇ 2 μ A Full-Shutdown Current
- ◆ External Differential Reference (1V to V_{DD})
- ◆ 16MHz, 3-Wire SPI/QSPI/MICROWIRE-/DSP-Compatible Serial Interface
- ◆ Wide -40°C to +125°C Operation
- ◆ Space-Saving, 32-Pin, 5mm x 5mm TQFN Packages
- ◆ 1Msps Conversion Rate, No Pipeline Delay

Applications

High-Speed Data Acquisition Systems
High-Speed Closed-Loop Systems
Industrial Control Systems
Medical Instrumentation
Battery-Powered Instruments
Portable Systems

For related parts and recommended products to use with this part, refer to www.maximintegrated.com/MAX11321-MAX11328.related.

MAX11321–MAX11328

1Msps, 10-/12-Bit, 4-/8-/16-Channel ADCs with Post-Mux External Signal Conditioning Access

ABSOLUTE MAXIMUM RATINGS

V _{DD} to GND.....	-0.3V to +4V	Continuous Power Dissipation (T _A = +70°C)	
AOP, AON, AIP, AIN, OVDD, AIN0–AIN13, CNVST/AIN14, REF+, REF-/AIN15 to GND.....	-0.3V to the lower of (V _{DD} + 0.3V) and +4V	TQFN (derate 34.4mW/°C above +70°C).....	2758mW
CS, SCLK, DIN, DOUT, EOC TO GND.....	-0.3V to the lower of (V _{OVDD} + 0.3V) and +4V	Operating Temperature Range.....	-40°C to +125°C
DGND to GND.....	-0.3V to +0.3V	Junction Temperature.....	+150°C
Input/Output Current (all pins).....	50mA	Storage Temperature Range.....	-65°C to +150°C

Stresses beyond those listed under "Absolute Maximum Ratings" may cause permanent damage to the device. These are stress ratings only, and functional operation of the device at these or any other conditions beyond those indicated in the operational sections of the specifications is not implied. Exposure to absolute maximum rating conditions for extended periods may affect device reliability.

PACKAGE THERMAL CHARACTERISTICS (Note 1)

TQFN

Junction-to-Ambient Thermal Resistance (θ _{JA}).....	29°C/W
Junction-to-Case Thermal Resistance (θ _{JC}).....	1.7°C/W

Note 1: Package thermal resistances were obtained using the method described in JEDEC specification JESD51-7, using a four-layer board. For detailed information on package thermal considerations, refer to www.maximintegrated.com/thermal-tutorial.

ELECTRICAL CHARACTERISTICS (MAX11322/MAX11325/MAX11328)

(V_{DD} = 2.35V to 3.6V, V_{OVDD} = 1.5V to 3.6V, f_{SAMPLE} = 1Msps, f_{SCLK} = 16MHz, 50% duty cycle, V_{REF+} = V_{DD}, T_A = -40°C to +125°C, unless otherwise noted. Typical values are at T_A = +25°C.) (Note 2)

PARAMETER	SYMBOL	CONDITIONS	MIN	TYP	MAX	UNITS
DC ACCURACY (Notes 3 and 4)						
Resolution	RES	12 bit	12			Bits
Integral Nonlinearity	INL				±1.0	LSB
Differential Nonlinearity	DNL	No missing codes			±1.0	LSB
Offset Error				1.2	±3.0	LSB
Gain Error		(Note 5)		0.02	±5.5	LSB
Offset Error Temperature Coefficient	OE _{TC}			±2		ppm/°C
Gain Temperature Coefficient	GE _{TC}			±0.8		ppm/°C
Channel-to-Channel Offset Matching				±0.5		LSB
Line Rejection	PSR	(Note 6)		0.3	±2	LSB/V
DYNAMIC PERFORMANCE (100kHz, Input Sine Wave) (Notes 3 and 7)						
Signal-to-Noise Plus Distortion	SINAD		70	71.9		dB
Signal-to-Noise Ratio	SNR		70	72.3		dB
Total Harmonic Distortion (Up to the 5th Harmonic)	THD			-83	-76	dB
Spurious-Free Dynamic Range	SFDR		77	84		dB
Intermodulation Distortion	IMD	f ₁ = 99.2432kHz, f ₂ = 69.2139kHz		-85		dB
Full-Power Bandwidth		-3dB		30		MHz
		-0.1dB		5		
Full-Linear Bandwidth		SINAD ≥ 70dB		0.5		MHz

MAX11321–MAX11328

1Msps, 10-/12-Bit, 4-/8-/16-Channel ADCs with Post-Mux External Signal Conditioning Access

ELECTRICAL CHARACTERISTICS (MAX11322/MAX11325/MAX11328) (continued)

($V_{DD} = 2.35V$ to $3.6V$, $V_{OVDD} = 1.5V$ to $3.6V$, $f_{SAMPLE} = 1Msps$, $f_{SCLK} = 16MHz$, 50% duty cycle, $V_{REF+} = V_{DD}$, $T_A = -40^{\circ}C$ to $+125^{\circ}C$, unless otherwise noted. Typical values are at $T_A = +25^{\circ}C$.) (Note 2)

PARAMETER	SYMBOL	CONDITIONS	MIN	TYP	MAX	UNITS
Crosstalk		-0.5dB below full-scale of 99.2432kHz sine wave input to the channel being sampled, apply full-scale 69.2139kHz sine wave signal to all 15 nonselected input channels.		-88		dB
CONVERSION RATE						
Power-Up Time	t_{PU}	Conversion cycle, external clock			2	Cycles
Acquisition Time	t_{ACQ}			156		ns
Conversion Time	t_{CONV}	Internally clocked (Note 8)		5.9		μs
		Externally clocked, $f_{SCLK} = 16MHz$, 16 cycles (Note 8)	1000			ns
External Clock Frequency	f_{SCLK}		0.16		16	MHz
Aperture Delay				8		ns
Aperture Jitter		RMS		30		ps
ANALOG INPUT						
Input Voltage Range	V_{INA}	Unipolar, (single ended and pseudo-differential)	0		V_{REF+}	V
		Bipolar (Note 9)	Range bit set to 0	$-V_{REF+}/2$	$V_{REF+}/2$	
			Range bit set to 1	$-V_{REF+}$	V_{REF+}	
Absolute Input Voltage Range		A_{IN+} , A_{IN-} relative to GND	-0.1		$V_{REF+} + 0.1$	V
Static Input Leakage Current	I_{ILA}	$V_{AIN} = V_{DD}$, GND		-0.1	± 1.5	μA
Input Capacitance	C_{AIN}	During acquisition time; RANGE bit = 0 (Note 10)		15		pF
		During acquisition time; RANGE bit = 1 (Note 10)		7.5		
EXTERNAL REFERENCE INPUT						
REF- Input Voltage Range	V_{REF-}		-0.3		+1	V
REF+ Input Voltage Range	V_{REF+}		1		$V_{DD} + 50mV$	V
REF+ Input Current	I_{REF+}	$V_{REF+} = 2.5V$, $f_{SAMPLE} = 1Msps$		36.7		μA
		$V_{REF+} = 2.5V$, $f_{SAMPLE} = 0Msps$		0.1		
DIGITAL INPUTS (SCLK, DIN, CS, CNVST)						
Input Voltage Low	V_{IL}				$V_{OVDD} \times 0.25$	V
Input Voltage High	V_{IH}				$V_{OVDD} \times 0.75$	V
Input Hysteresis	V_{HYST}				$V_{OVDD} \times 0.15$	mV

MAX11321–MAX11328

1Msps, 10-/12-Bit, 4-/8-/16-Channel ADCs with Post-Mux External Signal Conditioning Access

ELECTRICAL CHARACTERISTICS (MAX11322/MAX11325/MAX11328) (continued)

($V_{DD} = 2.35V$ to $3.6V$, $V_{OVDD} = 1.5V$ to $3.6V$, $f_{SAMPLE} = 1Msps$, $f_{SCLK} = 16MHz$, 50% duty cycle, $V_{REF+} = V_{DD}$, $T_A = -40^{\circ}C$ to $+125^{\circ}C$, unless otherwise noted. Typical values are at $T_A = +25^{\circ}C$.) (Note 2)

PARAMETER	SYMBOL	CONDITIONS	MIN	TYP	MAX	UNITS
Input Leakage Current	I_{IN}	$V_{AIN} = 0V$ or V_{DD}		± 0.09	± 1.0	μA
Input Capacitance	C_{IN}			3		pF
DIGITAL OUTPUTS (DOUT, \overline{EOC})						
Output Voltage Low	V_{OL}	$I_{SINK} = 200\mu A$			$V_{OVDD} \times 0.15$	V
Output Voltage High	V_{OH}	$I_{SOURCE} = 200\mu A$	V_{OVDD}	$\times 0.85$		V
Three-State Leakage Current	I_L	$\overline{CS} = V_{DD}$		-0.3	± 1.5	μA
Three-State Output Capacitance	C_{OUT}	$\overline{CS} = V_{DD}$		4		pF
POWER REQUIREMENTS						
Positive Supply Voltage	V_{DD}		2.35	3.0	3.6	V
Digital I/O Supply Voltage	V_{OVDD}		1.5	3.0	3.6	V
Positive Supply Current	I_{DD}	$f_{SAMPLE} = 1Msps$		1.8	2.5	mA
		$f_{SAMPLE} = 0Msps$ (1Msps devices)		1		
		Full shutdown		0.0015	0.006	
Power Dissipation	Normal mode (External Reference)	$V_{DD} = 3V$, $f_{SAMPLE} = 1Msps$		5.4		mW
		$V_{DD} = 2.35V$, $f_{SAMPLE} = 1Msps$		3.8		
	AutoStandby	$V_{DD} = 3V$, $f_{SAMPLE} = 1Msps$		2.6		
		$V_{DD} = 2.35V$, $f_{SAMPLE} = 1Msps$		1.6		
	Full/ AutoShutdown	$V_{DD} = 3V$		4.5		μW
		$V_{DD} = 2.35V$		2.1		
TIMING CHARACTERISTICS (Figure 1) (Note 11)						
SCLK Clock Period	t_{CP}	Externally clocked conversion	62.4			ns
SCLK Duty Cycle	t_{CH}		40		60	%
SCLK Fall to DOUT Transition	t_{DOT}	$C_{LOAD} = 10pF$	$V_{OVDD} = 1.5V$ to $2.35V$	4	16.5	ns
			$V_{OVDD} = 2.35V$ to $3.6V$	4	15	
16th SCLK Fall to DOUT Disable	t_{DOD}	$C_{LOAD} = 10pF$, channel ID on			15	ns
14th SCLK Fall to DOUT Disable		$C_{LOAD} = 10pF$, channel ID off			16	ns
SCLK Fall to DOUT Enable	t_{DOE}	$C_{LOAD} = 10pF$			14	ns
DIN to SCLK Rise Setup	t_{DS}		4			ns
SCLK Rise to DIN Hold	t_{DH}		1			ns

MAX11321–MAX11328

1MSPS, 10-/12-Bit, 4-/8-/16-Channel ADCs with Post-Mux External Signal Conditioning Access

ELECTRICAL CHARACTERISTICS (MAX11322/MAX11325/MAX11328) (continued)

($V_{DD} = 2.35V$ to $3.6V$, $V_{OVDD} = 1.5V$ to $3.6V$, $f_{SAMPLE} = 1MSPS$, $f_{SCLK} = 16MHz$, 50% duty cycle, $V_{REF+} = V_{DD}$, $T_A = -40^{\circ}C$ to $+125^{\circ}C$, unless otherwise noted. Typical values are at $T_A = +25^{\circ}C$.) (Note 2)

PARAMETER	SYMBOL	CONDITIONS	MIN	TYP	MAX	UNITS
\overline{CS} Fall to SCLK Fall Setup	t_{CSS}		4			ns
SCLK Fall to \overline{CS} Fall Hold	t_{CSH}		1			ns
\overline{CNVST} Pulse Width	t_{CSW}	See Figure 6	5			ns
\overline{CS} or \overline{CNVST} Rise to \overline{EOC} Low (Note 6)	t_{CNV_INT}	See Figure 7, $f_{SAMPLE} = 1MSPS$		5.3	6.2	μs
\overline{CS} Pulse Width	t_{CSBW}		5			ns

ELECTRICAL CHARACTERISTICS (MAX11321/MAX11324/MAX11327)

($V_{DD} = 2.35V$ to $3.6V$, $V_{OVDD} = 1.5V$ to $3.6V$, $f_{SAMPLE} = 1MSPS$, $f_{SCLK} = 16MHz$, 50% duty cycle, $V_{REF+} = V_{DD}$, $T_A = -40^{\circ}C$ to $+125^{\circ}C$, unless otherwise noted. Typical values are at $T_A = +25^{\circ}C$.) (Note 2)

PARAMETER	SYMBOL	CONDITIONS	MIN	TYP	MAX	UNITS
DC ACCURACY (Notes 3 and 4)						
Resolution	RES	10 bit	10			Bits
Integral Nonlinearity	INL				± 0.4	LSB
Differential Nonlinearity	DNL	No missing codes			± 0.4	LSB
Offset Error				0.7	± 1.2	LSB
Gain Error		(Note 5)		0	± 1.5	LSB
Offset Error Temperature Coefficient	OE_{TC}			± 2		ppm/ $^{\circ}C$
Gain Temperature Coefficient	GE_{TC}			± 0.8		ppm/ $^{\circ}C$
Channel-to-Channel Offset Matching				± 0.5		LSB
Line Rejection	PSR	(Note 6)		0.2	± 1.0	LSB/V
DYNAMIC PERFORMANCE (100kHz, Input Sine Wave) (Notes 3 and 7)						
Signal-to-Noise Plus Distortion	SINAD		61	61.5		dB
Signal-to-Noise Ratio	SNR		61	61.5		dB
Total Harmonic Distortion (Up to the 5th Harmonic)	THD			-82.5	-75	dB
Spurious-Free Dynamic Range	SFDR		76	83.4		dB
Intermodulation Distortion	IMD	$f_1 = 99.2432kHz$, $f_2 = 69.2139kHz$		-83		dB
Full-Power Bandwidth		-3dB		30		MHz
		-0.1dB		5		MHz
Full-Linear Bandwidth		SINAD $\geq 61dB$		0.5		MHz

MAX11321–MAX11328

1Msps, 10-/12-Bit, 4-/8-/16-Channel ADCs with Post-Mux External Signal Conditioning Access

ELECTRICAL CHARACTERISTICS (MAX11321/MAX11324/MAX11327) (continued)

($V_{DD} = 2.35V$ to $3.6V$, $V_{OVDD} = 1.5V$ to $3.6V$, $f_{SAMPLE} = 1Msps$, $f_{SCLK} = 16MHz$, 50% duty cycle, $V_{REF+} = V_{DD}$, $T_A = -40^{\circ}C$ to $+125^{\circ}C$, unless otherwise noted. Typical values are at $T_A = +25^{\circ}C$.) (Note 2)

PARAMETER	SYMBOL	CONDITIONS	MIN	TYP	MAX	UNITS
Crosstalk		-0.5dB below full-scale of 99.2432kHz sine-wave input to the channel being sampled; apply full-scale 69.2139kHz sine wave signal to all 15 nonselected input channels		-88		dB
CONVERSION RATE						
Power-Up Time	t_{PU}	Conversion cycle, external clock			2	Cycles
Acquisition Time	t_{ACQ}			156		ns
Conversion Time	t_{CONV}	Internally clocked, $f_{SAMPLE} = 1Msps$, (Note 8)		5.9		μs
		Externally clocked, $f_{SCLK} = 16MHz$, 16 cycles (Note 8)	1000			ns
External Clock Frequency	f_{SCLK}		0.16		16	MHz
Aperture Delay				8		ns
Aperture Jitter		RMS		30		ps
ANALOG INPUT						
Input Voltage Range	V_{INA}	Unipolar (single-ended and pseudo differential)	0		V_{REF+}	V
		Bipolar (Note 9)	RANGE bit set to 0	$-V_{REF+}/2$	$+V_{REF+}/2$	
			RANGE bit set to 1	$-V_{REF+}$	$+V_{REF+}$	
Absolute Input Voltage Range		A_{IN+} , A_{IN-} relative to GND	-0.1		$V_{REF+} + 0.1$	V
Static Input Leakage Current	I_{ILA}	$V_{AIN-} = V_{DD}$, GND		-0.1	± 1.5	μA
Input Capacitance	C_{AIN}	During acquisition time, RANGE bit = 0 (Note 10)		15		μF
		During acquisition time, RANGE bit = 1 (Note 10)		7.5		
EXTERNAL REFERENCE INPUT						
REF- Input Voltage Range	V_{REF-}		-0.3		+1	V
REF+ Input Voltage Range	V_{REF+}		1		$V_{DD} + 50mV$	V
REF+ Input Current	I_{REF+}	$V_{REF+} = 2.5V$, $f_{SAMPLE} = 1Msps$		36.7		μA
		$V_{REF+} = 2.5V$, $f_{SAMPLE} = 0Msps$		0.1		μA
DIGITAL INPUTS (SCLK, DIN, CS, CNVST)						
Input Voltage Low	V_{IL}				$V_{OVDD} \times 0.25$	V

MAX11321–MAX11328

1Msps, 10-/12-Bit, 4-/8-/16-Channel ADCs with Post-Mux External Signal Conditioning Access

ELECTRICAL CHARACTERISTICS (MAX11321/MAX11324/MAX11327) (continued)

($V_{DD} = 2.35V$ to $3.6V$, $V_{OVDD} = 1.5V$ to $3.6V$, $f_{SAMPLE} = 1Msps$, $f_{SCLK} = 16MHz$, 50% duty cycle, $V_{REF+} = V_{DD}$, $T_A = -40^{\circ}C$ to $+125^{\circ}C$, unless otherwise noted. Typical values are at $T_A = +25^{\circ}C$.) (Note 2)

PARAMETER	SYMBOL	CONDITIONS	MIN	TYP	MAX	UNITS
Input Voltage High	V_{IH}		$V_{OVDD} \times 0.75$			V
Input Hysteresis	V_{HYST}			$V_{OVDD} \times 0.15$		mV
Input Leakage Current	I_{IN}	$V_{AINL} = 0V$ or V_{DD}		± 0.09	± 1.0	μA
Input Capacitance	C_{IN}			3		pF
DIGITAL OUTPUTS (DOUT, EOC)						
Output Voltage Low	V_{OL}	$I_{SINK} = 200\mu A$			$V_{OVDD} \times 0.15$	V
Output Voltage High	V_{OH}	$I_{SOURCE} = 200\mu A$	$V_{OVDD} \times 0.85$			V
Three-State Leakage Current	I_L	$\overline{CS} = V_{DD}$		-0.3	± 1.5	μA
Three-State Output Capacitance	C_{OUT}	$\overline{CS} = V_{DD}$		4		pF
POWER REQUIREMENTS						
Positive Supply Voltage	V_{DD}		2.35	3.0	3.6	V
Digital I/O Supply Voltage	V_{OVDD}		1.5	3.0	3.6	V
Positive Supply Current	I_{DD}	$f_{SAMPLE} = 1Msps$		1.8	2.5	mA
		$f_{SAMPLE} = 0Msps$ (1Msps devices)		1		
		Full shutdown		0.0015	0.006	
Power Dissipation	Normal mode (external reference)	$V_{DD} = 3V$, $f_{SAMPLE} = 1Msps$		5.4		mW
		$V_{DD} = 2.35V$, $f_{SAMPLE} = 1Msps$		3.8		
	AutoStandby	$V_{DD} = 3V$, $f_{SAMPLE} = 1Msps$		2.6		
		$V_{DD} = 2.35V$, $f_{SAMPLE} = 1Msps$		1.6		
	Full/ AutoShutdown	$V_{DD} = 3V$		4.5		μW
		$V_{DD} = 2.35V$		2.1		
TIMING CHARACTERISTICS (Figure 1) (Note 11)						
SCLK Clock Period	t_{CP}	Externally clocked conversion	62.4			ns
SCLK Duty Cycle	t_{CH}		40		60	%
SCLK Fall to DOUT Transition	t_{DOT}	$C_{LOAD} = 10pF$	$V_{OVDD} = 1.5V$ to $2.35V$	4	16.5	ns
			$V_{OVDD} = 2.35V$ to $3.6V$	4	15	
16th SCLK Fall to DOUT Disable	t_{DOD}	$C_{LOAD} = 10pF$, channel ID on			15	ns
14th SCLK Fall to DOUT Disable		$C_{LOAD} = 10pF$, channel ID off			16	ns
SCLK Fall to DOUT Enable	t_{DOE}	$C_{LOAD} = 10pF$			14	ns

MAX11321–MAX11328

1MSPS, 10-/12-BIT, 4-/8-/16-CHANNEL ADCs with Post-Mux External Signal Conditioning Access

ELECTRICAL CHARACTERISTICS (MAX11321/MAX11324/MAX11327) (continued)

($V_{DD} = 2.35V$ to $3.6V$, $V_{OVDD} = 1.5V$ to $3.6V$, $f_{SAMPLE} = 1MSPS$, $f_{SCLK} = 16MHz$, 50% duty cycle, $V_{REF+} = V_{DD}$, $T_A = -40^{\circ}C$ to $+125^{\circ}C$, unless otherwise noted. Typical values are at $T_A = +25^{\circ}C$.) (Note 2)

PARAMETER	SYMBOL	CONDITIONS	MIN	TYP	MAX	UNITS
DIN to SCLK Rise Setup	t_{DS}		4			ns
SCLK Rise to DIN Hold	t_{DH}		1			ns
\overline{CS} Fall to SCLK Fall Setup	t_{CSS}		4			ns
SCLK Fall to \overline{CS} Fall Hold	t_{CSH}		1			ns
\overline{CNVST} Pulse Width	t_{CSW}	See Figure 6	5			ns
\overline{CS} or \overline{CNVST} Rise to \overline{EOC} Low (Note 7)	t_{CNV_INT}	See Figure 7, $f_{SAMPLE} = 1MSPS$		5.3	6.2	μs
\overline{CS} Pulse Width	t_{CSBW}		5			ns

Note 2: Limits are 100% production tested at $T_A = +25^{\circ}C$. Limits over the operating temperature range are guaranteed by design. Parts are tested with MUX externally connected to the ADC input.

Note 3: Channel ID disabled.

Note 4: Tested in single-ended mode.

Note 5: Offset nulled.

Note 6: Line rejection $\Delta(D_{OUT})$ with $V_{DD} = 2.35V$ to $3.6V$ and $V_{REF+} = 2.35V$.

Note 7: Tested and guaranteed with fully differential input.

Note 8: Conversion time is defined as the number of clock cycles multiplied by the clock period with a 50% duty cycle. Maximum conversion time: $4.73\mu s + N \times 16 \times t_{OSC_MAX}$

$t_{OSC_MAX} = 88.2ns$, $t_{OSC_TYP} = 75ns$.

Note 9: The operational input voltage range for each individual input of a differentially configured pair is from V_{DD} to GND. The operational input voltage difference is from $-V_{REF+}/2$ to $+V_{REF+}/2$ or $-V_{REF+}$ to $+V_{REF+}$.

Note 10: See [Figure 3](#) (Equivalent Input Circuit).

Note 11: Guaranteed by characterization.

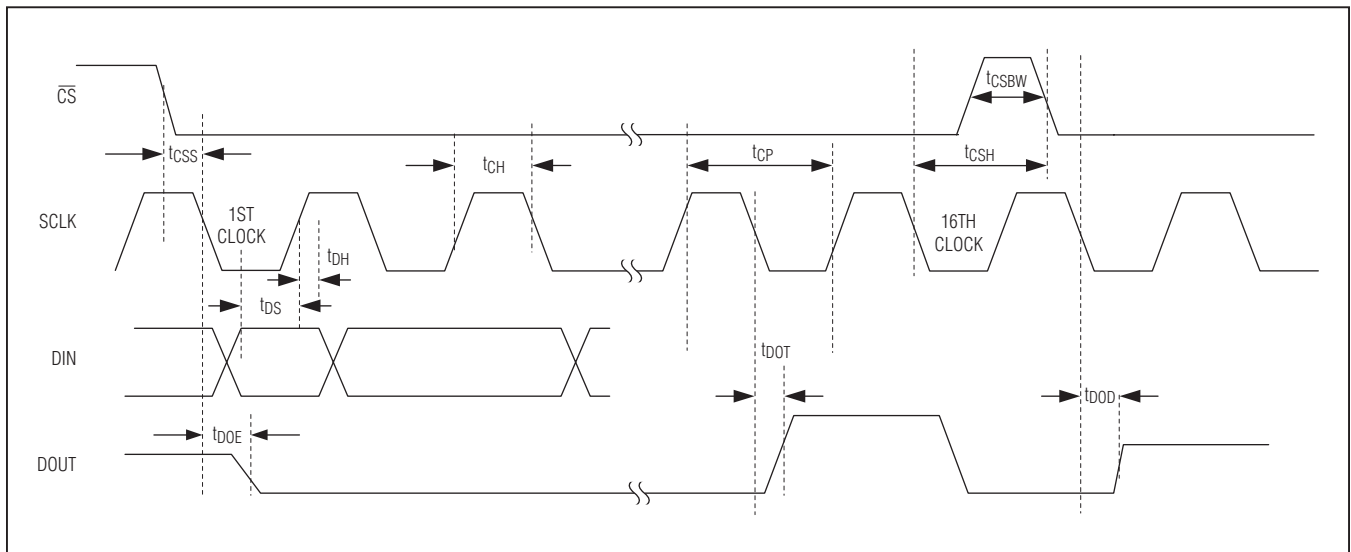

Figure 1. Detailed Serial-Interface Timing Diagram

MAX11321–MAX11328

1Msps, 10-/12-Bit, 4-/8-/16-Channel ADCs with Post-Mux External Signal Conditioning Access

Typical Operating Characteristics

(MAX11322ATJ+/MAX11325ATJ+/MAX11328ATJ+, $T_A = +25^\circ\text{C}$, unless otherwise noted.)

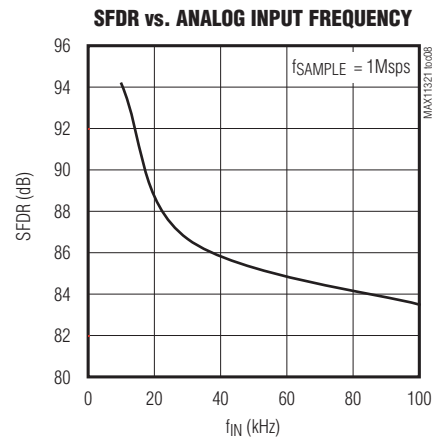
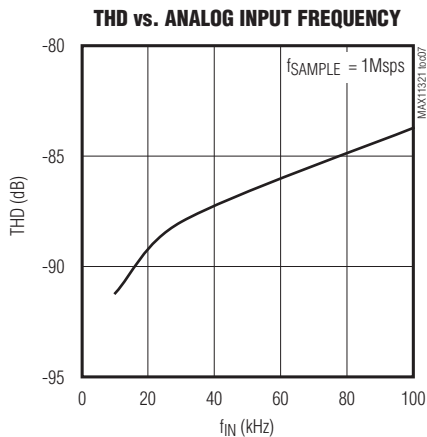
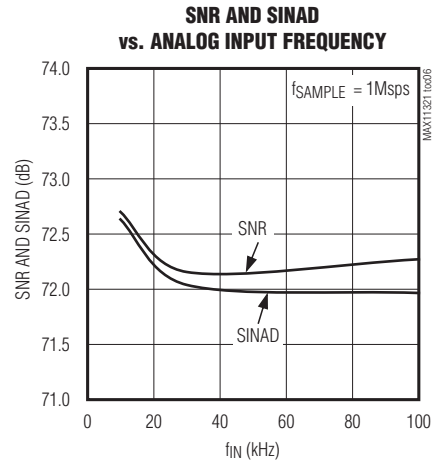
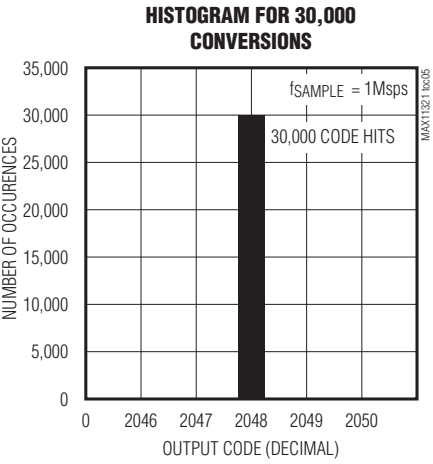
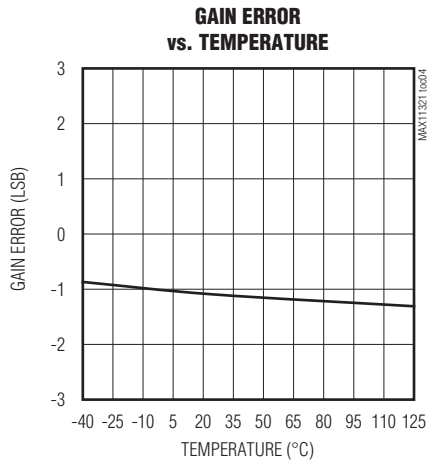
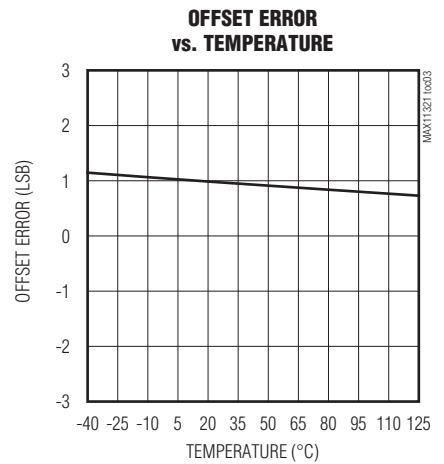
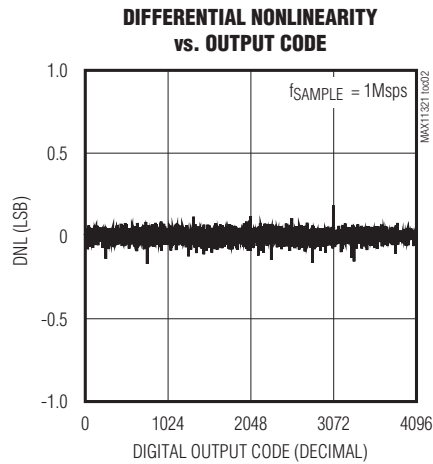
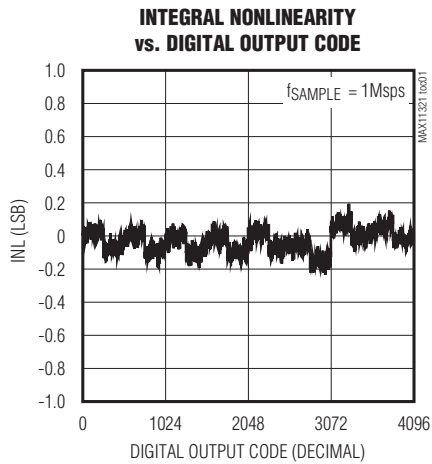

MAX11321-MAX11328

1Msps, 10-/12-Bit, 4-/8-/16-Channel ADCs with Post-Mux External Signal Conditioning Access

Typical Operating Characteristics (continued)

(MAX11322ATJ+/MAX11325ATJ+/MAX11328ATJ+, $T_A = +25^\circ\text{C}$, unless otherwise noted.)

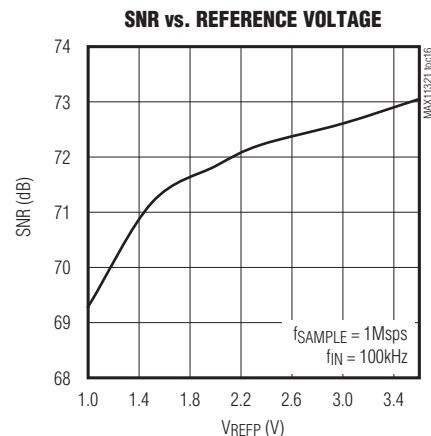
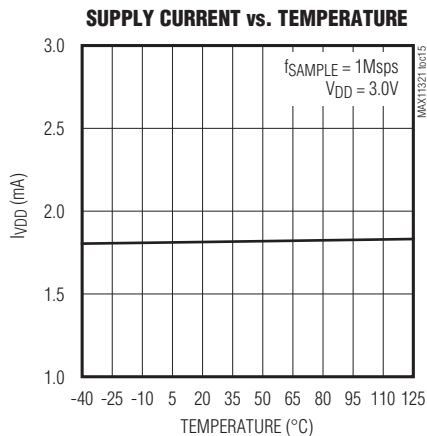
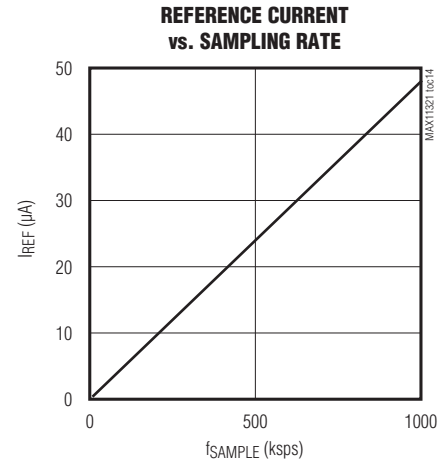
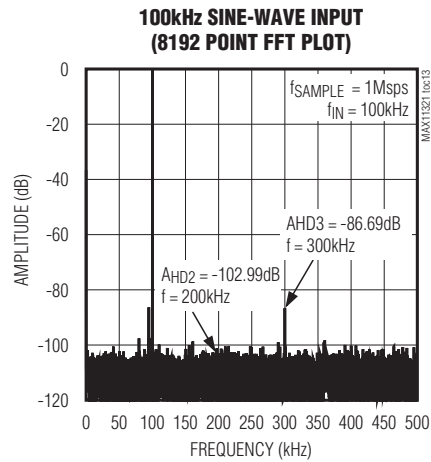
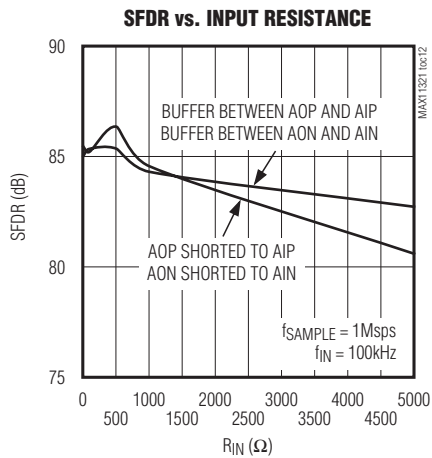
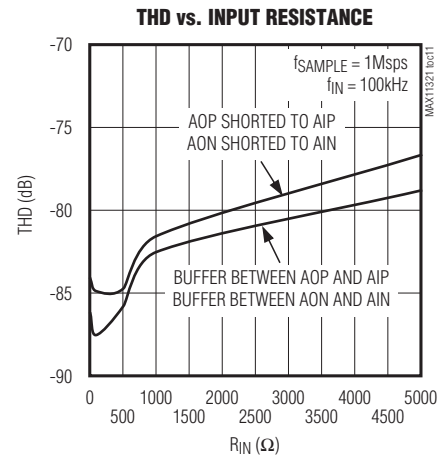
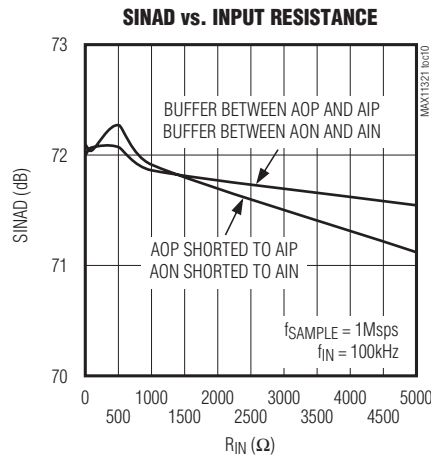
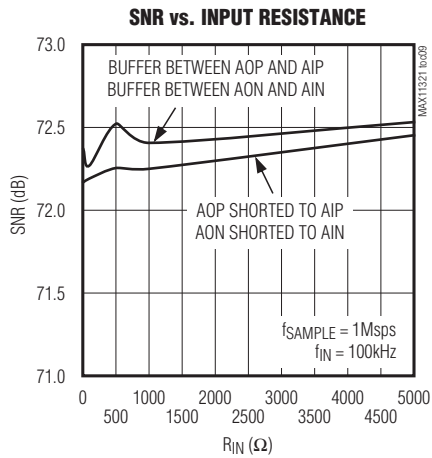

MAX11321–MAX11328

1MSPs, 10-/12-Bit, 4-/8-/16-Channel ADCs with Post-Mux External Signal Conditioning Access

Pin Configurations

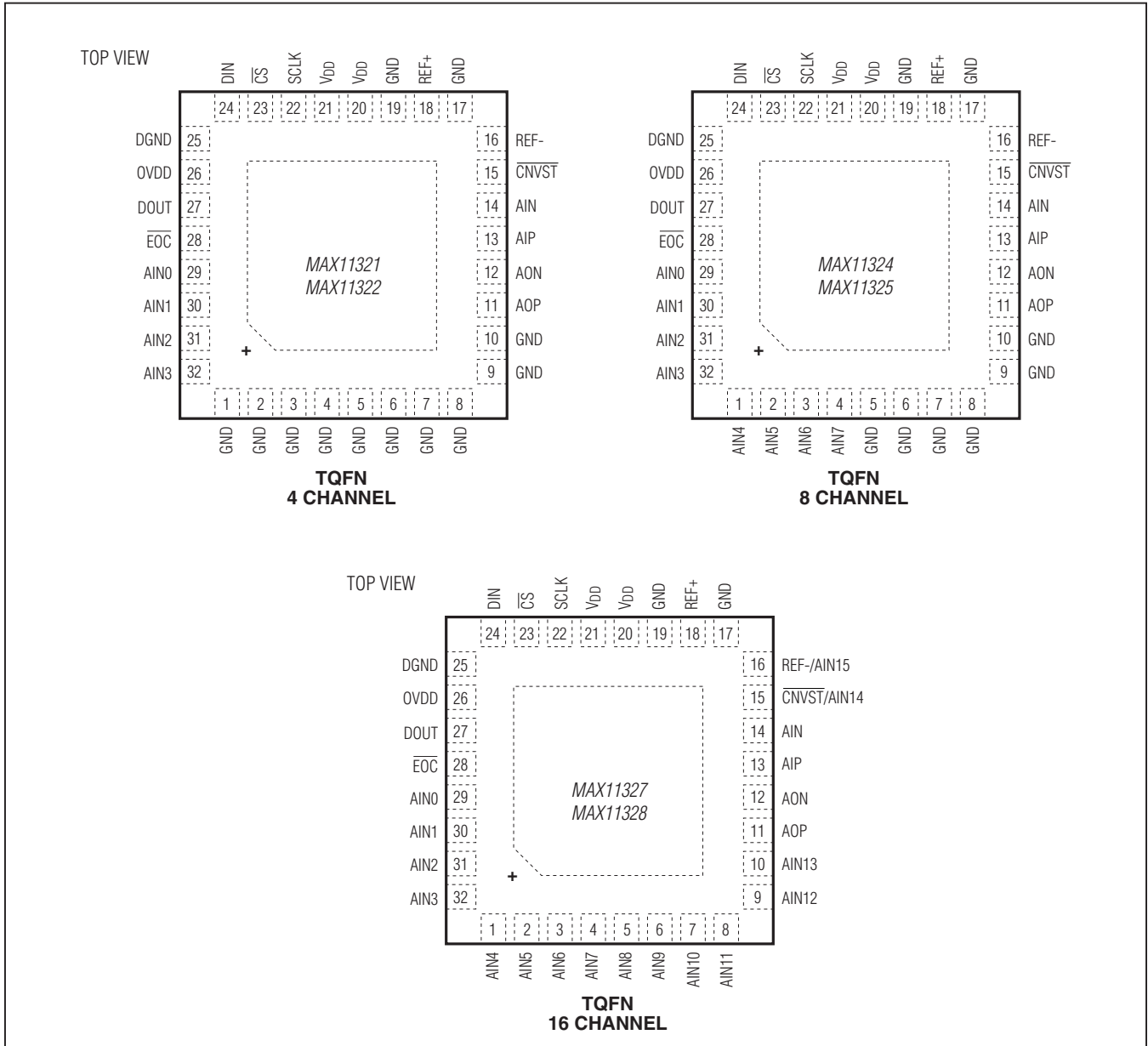

MAX11321–MAX11328

1Msps, 10-/12-Bit, 4-/8-/16-Channel ADCs with Post-Mux External Signal Conditioning Access

Pin Description

MAX11321 MAX11322 (4 CHANNEL)	MAX11324 MAX11325 (8 CHANNEL)	MAX11327 MAX11328 (16 CHANNEL)	NAME	FUNCTION
1–10, 17, 19	5–10, 17, 19	17, 19	GND	Ground
11	11	11	AOP	Positive Output from the Multiplexer
12	12	12	AON	Negative Output from the Multiplexer
13	13	13	AIP	Positive Input to the ADC
14	14	14	AIN	Negative Input to the ADC
15	15	—	$\overline{\text{CNVST}}$	Active-Low Conversion Start Input
16	16	—	REF-	External Differential Reference Negative Input
18	18	18	REF+	External Positive Reference Input. Apply a reference voltage at REF+. Bypass to GND with a 0.47 μ F capacitor.
20, 21	20, 21	20, 21	V _{DD}	Power-Supply Input. Bypass to GND with a 10 μ F in parallel with a 0.1 μ F capacitors.
22	22	22	SCLK	Serial Clock Input. Clocks data in and out of the serial interface.
23	23	23	$\overline{\text{CS}}$	Active-Low Chip Select Input. When $\overline{\text{CS}}$ is low, the serial interface is enabled. When $\overline{\text{CS}}$ is high, DOUT is high impedance or three-state.
24	24	24	DIN	Serial Data Input. DIN data is latched into the serial interface on the rising edge of SCLK.
25	25	25	DGND	Digital I/O Ground
26	26	26	OVDD	Digital Power-Supply Input. Bypass to GND with a 10 μ F in parallel with a 0.1 μ F capacitors.
27	27	27	DOUT	Serial Data Output. Data is clocked out on the falling edge of SCLK. When $\overline{\text{CS}}$ is high, DOUT is high impedance or three-state.
28	28	28	$\overline{\text{EOC}}$	End of Conversion Output. Data is valid after $\overline{\text{EOC}}$ is driven low (internal clock mode only).
29–32	—	—	AIN0–AIN3	Analog Inputs
—	—	29–32, 1–10	AIN0–AIN13	Analog Inputs
—	29–32, 1–4	—	AIN0–AIN7	Analog Inputs
—	—	15	$\overline{\text{CNVST}}$ / AIN14	Active-Low Conversion Start Input/Analog Input 14
—	—	16	REF-/AIN15	External Differential Reference Negative Input /Analog Input 15
—	—	—	EP	Exposed Pad. Connect EP directly to GND plane for guaranteed performance.

MAX11321–MAX11328

1Msps, 10-/12-Bit, 4-/8-/16-Channel ADCs with Post-Mux External Signal Conditioning Access

Functional Diagrams

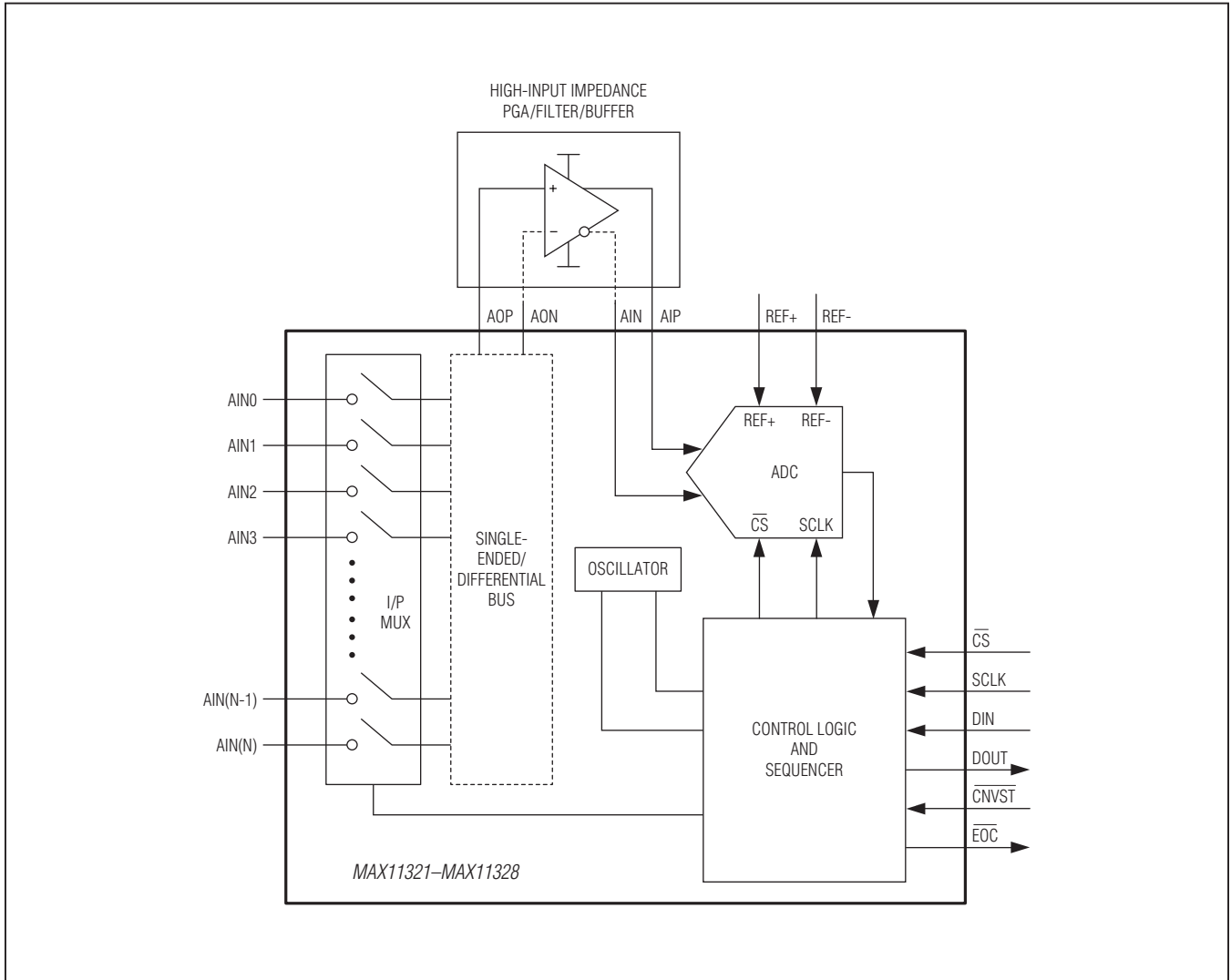

MAX11321–MAX11328

1Msps, 10-/12-Bit, 4-/8-/16-Channel ADCs with Post-Mux External Signal Conditioning Access

Functional Diagrams (continued)

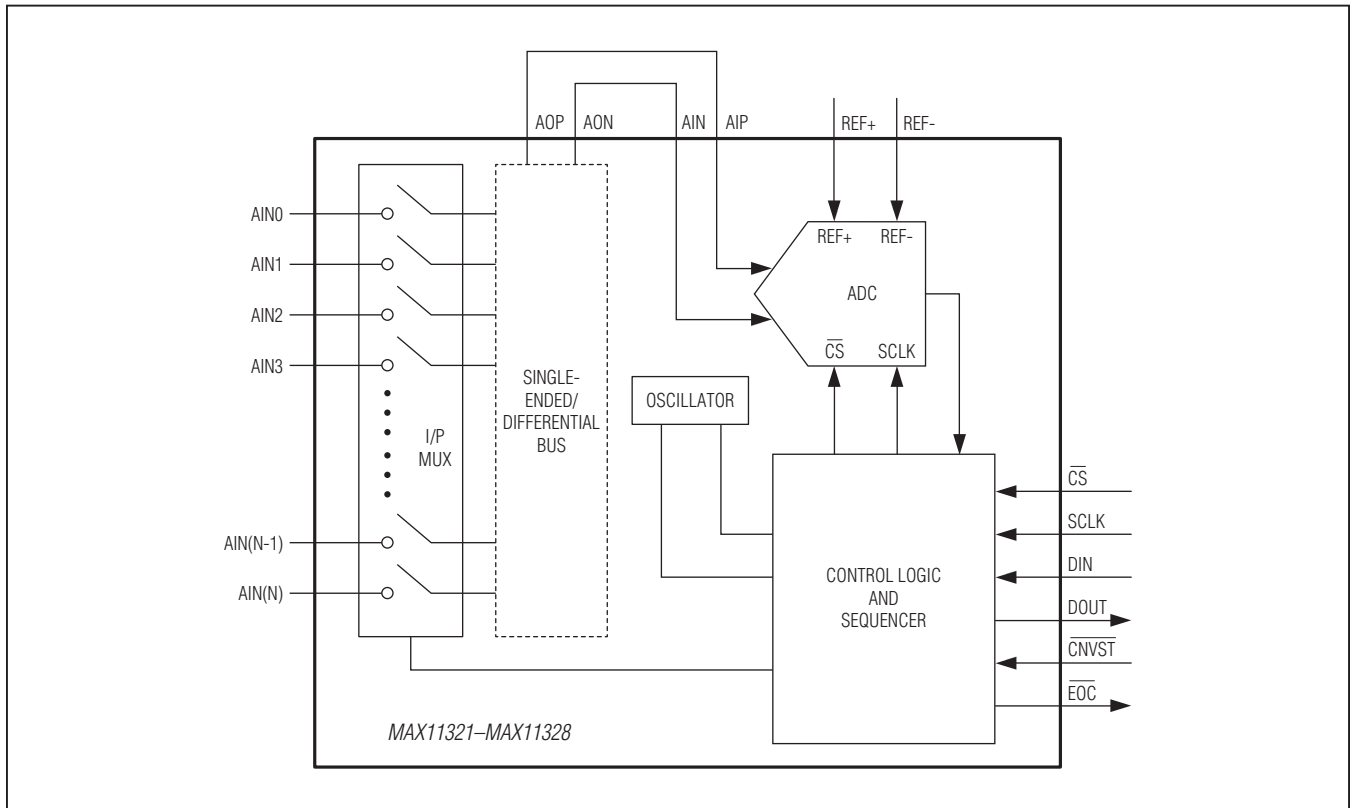

Detailed Description

The MAX11321–MAX11328 are 12-/10-bit with external reference and industry-leading 500kHz, full linear bandwidth, high-speed, low-power, serial output successive approximation register (SAR) analog-to-digital converters (ADC). These devices feature scan mode, internal averaging to increase SNR, and AutoShutdown.

The external clock mode features the SampleSet technology, a user-programmable analog input channel sequencer. The user may define and load a unique sequencing pattern into the ADC allowing both high- and low-frequency inputs to be converted without interface activity. This feature frees the controlling unit for other tasks while lowering overall system noise and power consumption.

The MAX11321–MAX11328 include internal clock. The internal clock mode features an integrated FIFO, allowing data to be sampled at high speed and then held for read-out at any time or at a lower clock rate. Internal averaging

is also supported in this mode improving SNR for noisy input signals. All input channels are configurable for single-ended, fully differential or pseudo-differential inputs in unipolar or bipolar mode. The MAX11321–MAX11328 operate from a 2.35V to 3.6V supply and consume only 5.4mW at 1Msps.

The MAX11321–MAX11328 include AutoShutdown, fast wake-up, and a high-speed 3-wire serial interface. The devices feature full power-down mode for optimal power management.

Data is converted from analog voltage sources in a variety of channel and data-acquisition configurations. Microprocessor (μ P) control is made easy through a 3-wire SPI-/QSPI-/MICROWIRE-compatible serial interface.

AOP and AON are the output pins of the internal multiplexer while AIP and AIN are the ADC inputs which are all accessible externally through pins. This allows flexibility to the system designer to process all signals through one PGA (programmable gain amplifier), filter or gain stage

MAX11321–MAX11328

1MSPs, 10-/12-Bit, 4-/8-/16-Channel ADCs with Post-Mux External Signal Conditioning Access

in single-ended or differential configuration. The external buffering stage should be designed to properly drive the input sampling network of the ADC.

The external buffer should also have very high input impedance (low-leakage current) to ensure best linearity. If additional signal processing is not required, connect AOP to AIP and AON to AIN. It is recommended to limit the source impedance to not affect the sampling accuracy of the ADC causing degradation in linearity and total harmonic distortion. See the SINAD vs. Input Resistance graph in the [Typical Operating Characteristics](#).

Input Bandwidth

The ADC's input-tracking circuitry features a 500MHz small-signal full-linear bandwidth to digitize high-speed transient events and measure periodic signals with bandwidths exceeding the ADC's sampling rate by using undersampling techniques. Anti-alias filtering of the input signals is necessary to avoid high-frequency signals aliasing into the frequency band of interest.

3-Wire Serial Interface

The MAX11321–MAX11328 feature a serial interface compatible with SPI/QSPI and MICROWIRE devices. For SPI/QSPI, ensure the CPU serial interface runs in master

mode to generate the serial clock signal. Select the SCLK frequency of 48MHz or less, and set clock polarity (CPOL) and phase (CPHA) in the control registers to the same value. The MAX11321–MAX11328 operate with SCLK idling high, and thus operate with CPOL = CPHA = 1.

Set \overline{CS} low to latch input data at DIN on the rising edge of SCLK. Output data at DOUT is updated on the falling edge of SCLK. A high-to-low transition on \overline{CS} samples the analog inputs and initiates a new frame. A frame is defined as the time between two falling edges of \overline{CS} . There is a minimum of 16 bits per frame. The serial data input, DIN, carries data into the control registers clocked in by the rising edge of SCLK. The serial data output, DOUT, delivers the conversion results and is clocked out by the falling edge of SCLK. DOUT is a 16-bit data word containing a 4-bit channel address, followed by a 12-bit conversion result led by the MSB when CHAN_ID is set to 1 in the ADC Mode Control register ([Figure 2a](#)). When CHAN_ID is set to 1 keep the SCLK high for at least 25ns before the \overline{CS} falling edge ([Figure 2b](#)). When CHAN_ID is set to 0 (external clock mode only), the 16-bit data word includes a leading zero and the 12-bit conversion result is followed by 3 trailing zeros ([Figure 2c](#)). In the 10-bit conversion result is followed by 5 trailing zeros.

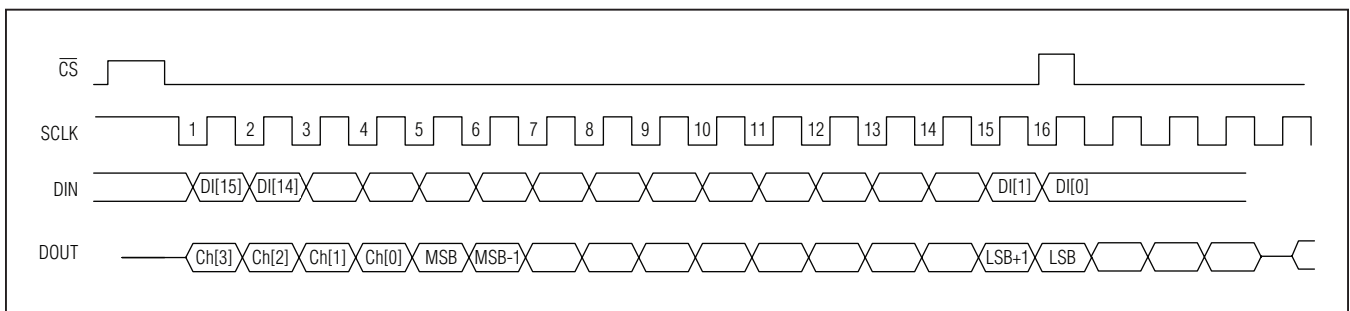

Figure 2a. External Clock Mode Timing Diagram with CHAN_ID=1

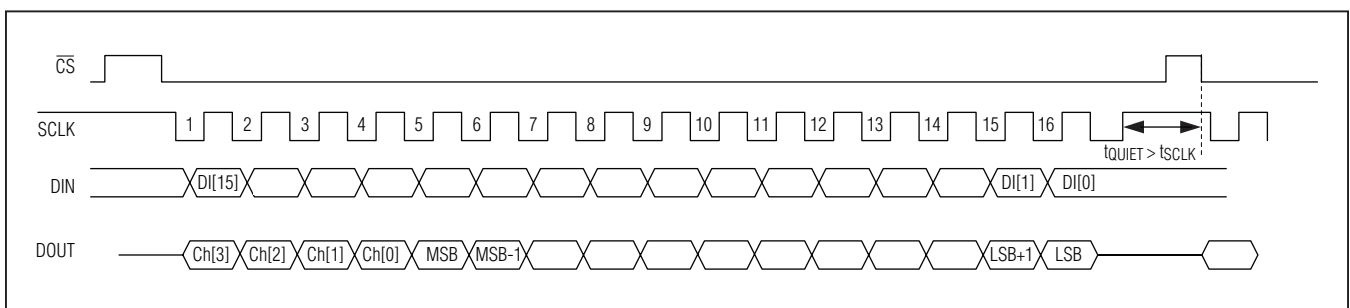

Figure 2b. External Clock Mode Timing Diagram with CHAN_ID=1 for Best Performance

MAX11321–MAX11328

1MSPs, 10-/12-Bit, 4-/8-/16-Channel ADCs with Post-Mux External Signal Conditioning Access

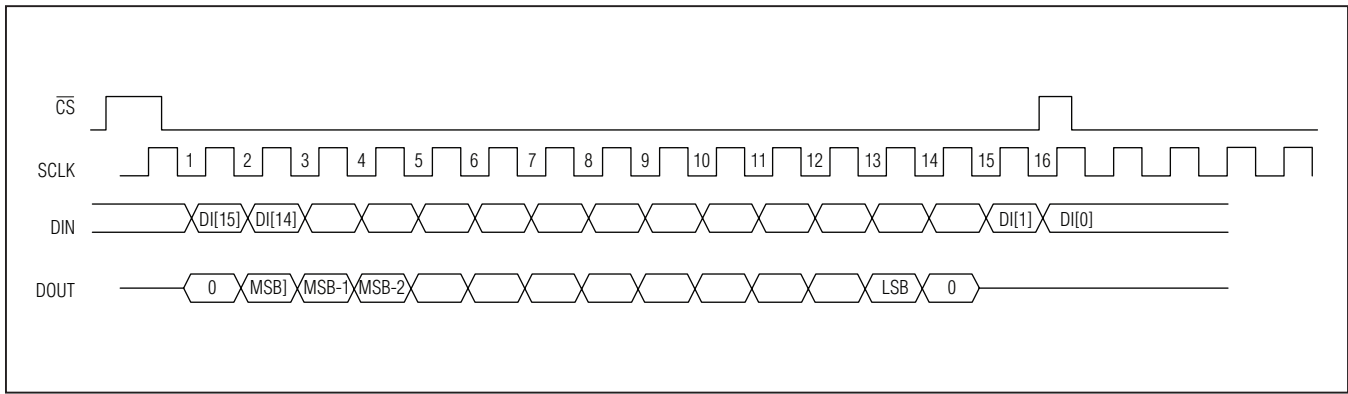

Figure 2c. External Clock Mode Timing Diagram with CHAN_ID=0

Single-Ended, Differential, and Pseudo-Differential Input

The MAX11321–MAX11328 include up to 16 analog input channels that can be configured on a pin-by-pin basis to 16 single-ended inputs, 8 fully differential pairs, or 15 pseudo-differential inputs with respect to one common input (REF-/AIN15 is the common input).

The analog input range is 0V to V_{REF+} in single-ended and pseudo-differential mode (unipolar) and $\pm V_{REF+}/2$ or $\pm V_{REF+}$ in fully differential mode (bipolar) depending on the RANGE register settings. See [Table 7](#) for the RANGE register settings.

Unipolar mode sets the differential input range from 0 to V_{REF+} . If the positive analog input swings below the negative analog input in unipolar mode, the digital output code is zero. Selecting bipolar mode sets the differential input range to $\pm V_{REF+}/2$ or $\pm V_{REF+}$ depending on the RANGE register settings ([Table 7](#)).

In single-ended mode, the ADC always operates in unipolar mode. The analog inputs are internally referenced to GND with a full-scale input range from 0V to V_{REF+} . Single-ended conversions are internally referenced to GND ([Figure 3](#)).

The MAX11321–MAX11328 feature up to 15 pseudo-differential inputs by setting the PDIFF_COM bits in the Unipolar register to 1 ([Table 10](#)). The 15 analog input signals inputs are referenced to a DC signal applied to the REF-/AIN15.

Fully Differential Reference (REF+, REF-)

When the reference is used in fully differential mode (REFSEL = 1), the full-scale range is set by the difference between REF+ and REF-. The output code reaches its

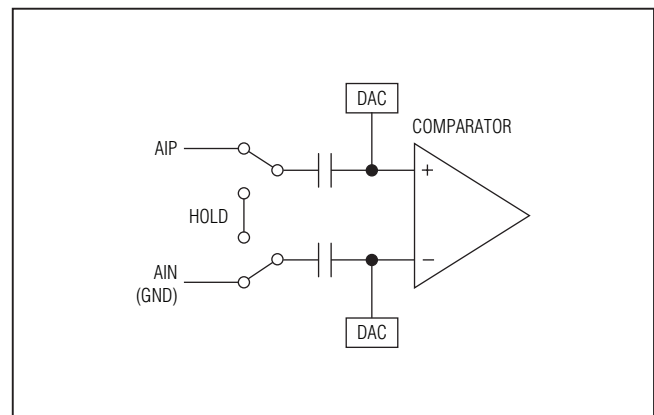

Figure 3. Equivalent Input Circuit

maximum value if the input signal exceeds this reference range.

ADC Transfer Function

The output format of the MAX11321–MAX11328 is straight binary in unipolar mode and two's complement in bipolar mode. The code transitions midway between successive integer LSB values, such as 0.5 LSB, 1.5 LSB. [Figure 4](#) and [Figure 5](#) show the unipolar and bipolar transfer function, respectively. Output coding is binary, with for example, 1 LSB = $V_{REF+}/4096$ in the 12-bit devices such as the MAX11322/MAX11325/MAX11328.

Internal FIFO

The MAX11321–MAX11328 contain a FIFO buffer that can hold up to 16 ADC results. This allows the ADC to handle multiple internally clocked conversions without tying up the serial bus. If the FIFO is filled and further conversions are requested without reading from the FIFO, the oldest ADC results are overwritten by the new ADC results. Each

MAX11321–MAX11328

1MSPS, 10-/12-Bit, 4-/8-/16-Channel ADCs with Post-Mux External Signal Conditioning Access

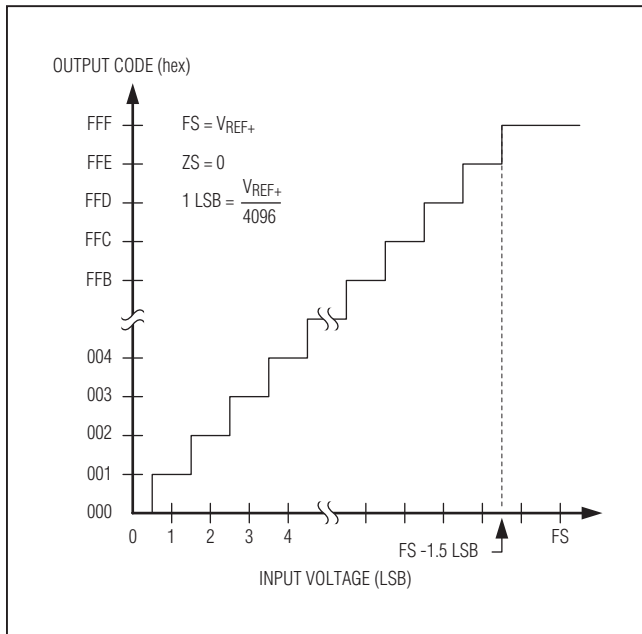

Figure 4. Unipolar Transfer Function for 12-Bit Resolution

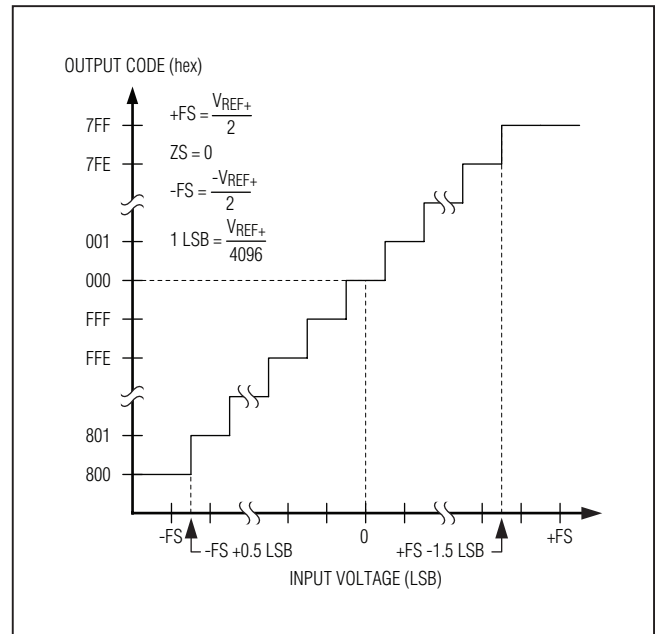

Figure 5. Bipolar Transfer Function for 12-Bit Resolution

result contains 2 bytes, with the MSB preceded by four leading channel address bits. After each falling edge of \overline{CS} , the oldest available byte of data is available at DOUT. When the FIFO is empty, DOUT is zero.

External Clock

Apply a soft reset when changing from internal to external clock mode: RESET [1:0] = 10. The detailed operation of external clock mode is dependent on the mode of operation selected for the device using SCAN[3:0] bit settings (see [Table 3](#)). In external clock mode the analog inputs are sampled at the falling edge of \overline{CS} . Serial clock (SCLK) is used to perform the conversion.

Depending on the mode selected, the sequencer reads in the channel to be converted from the serial data input (DIN) at each frame (e.g. manual mode). The conversion results are sent to the serial output (DOUT) at the next frame.

In other external clocked modes the sequence of channel to be converted is determined by the mode (SCAN[3:0]) selected in [Table 3](#). See the [Applications Information](#) for more detail on programming modes.

Internal Clock

Apply a soft reset when changing from internal to external clock mode: RESET [1:0] = 10. The MAX11321–MAX11328 operate from an internal oscillator, which is accurate within $\pm 15\%$ of the 13.33MHz nominal clock rate. Request internally timed conversions by writing the appropriate sequence to the ADC Mode Control register ([Table 2](#)).

The wake-up, acquisition, conversion, and shutdown sequences are initiated through \overline{CNVST} and are performed automatically using the internal oscillator. Results are added to the internal FIFO.

With \overline{CS} high, initiate a scan by setting \overline{CNVST} low for at least 5ns before pulling it high ([Figure 6](#)). Then, the MAX11321–MAX11328 wake up, scan all requested channels, store the results in the FIFO, and shut down. After the scan is complete, \overline{EOC} is pulled low and the results are available in the FIFO. Wait until \overline{EOC} goes low before pulling \overline{CS} low to communicate with the serial interface. \overline{EOC} stays low until \overline{CS} or \overline{CNVST} is pulled low again. Do not initiate a second \overline{CNVST} before \overline{EOC} goes low; otherwise, the FIFO may become corrupted.

MAX11321–MAX11328

1MSPS, 10-/12-Bit, 4-/8-/16-Channel ADCs with Post-Mux External Signal Conditioning Access

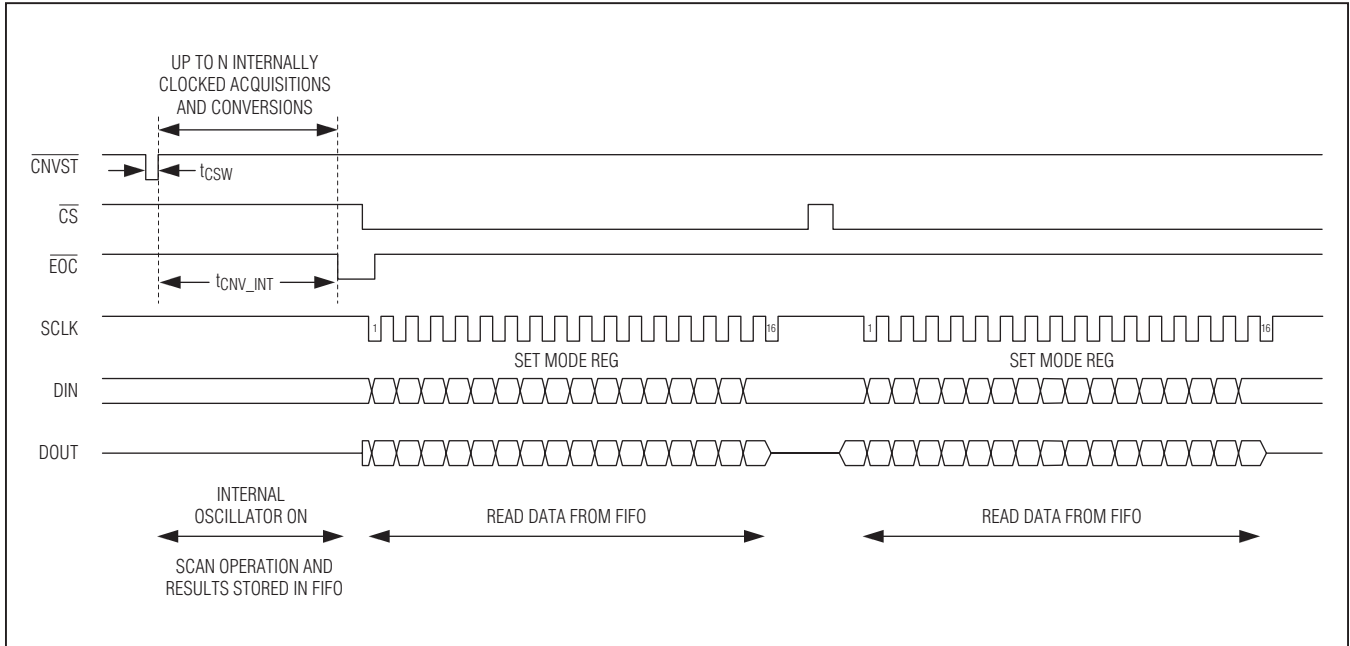

Figure 6. Internal Conversions with \overline{CNVST}

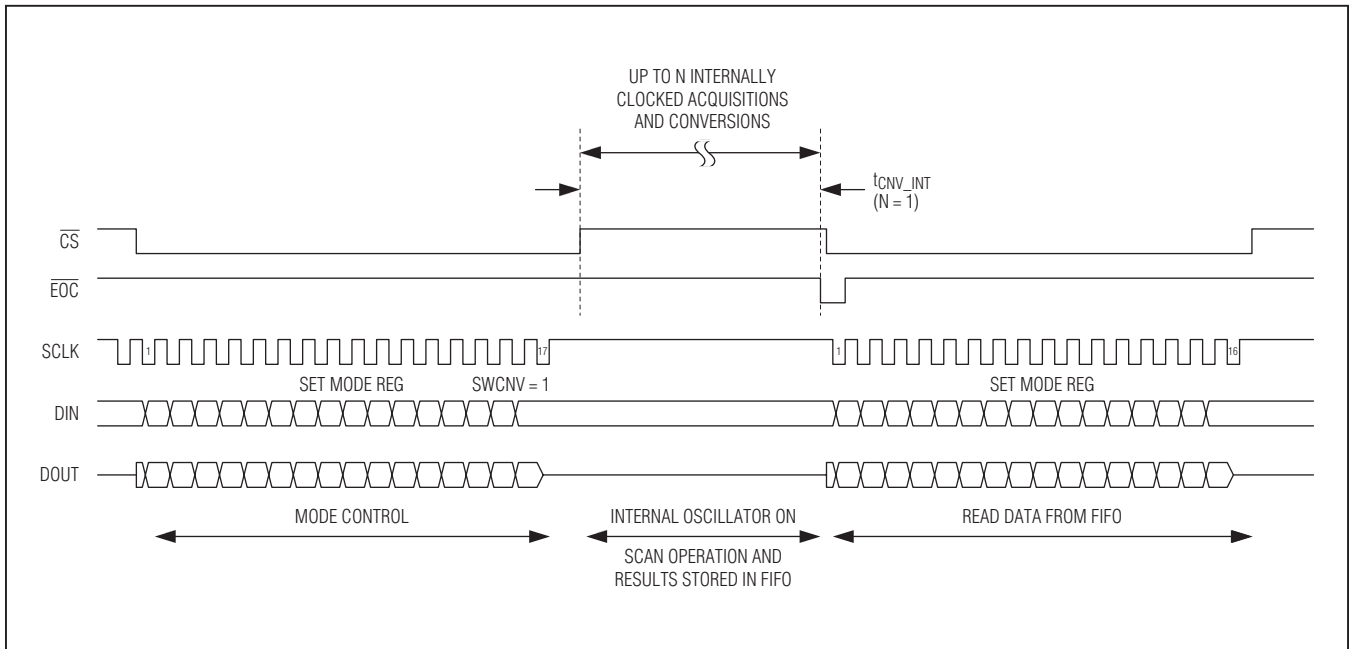

Figure 7. Internal Conversions with SWCNV

MAX11321–MAX11328

1MSPS, 10-/12-Bit, 4-/8-/16-Channel ADCs with Post-Mux External Signal Conditioning Access

Alternatively, set SWCNV to 1 in the ADC Mode Control register (Figure 4) to initiate conversions with \overline{CS} rising edge instead of cycling \overline{CNVST} (Table 2). For proper operation, \overline{CS} must be held low for 17 clock cycles to guarantee that the device interprets the SWCNV setting. Wait until EOC goes low before pulling \overline{CS} low to communicate with the serial interface. Upon completing the conversion, SWCNV is reset to 0 (Figure 7).

Analog Input

The MAX11321–MAX11328 produce a digital output that corresponds to the analog input voltage as long as the analog inputs are within the specified operating range. Internal protection diodes confine the analog input voltage within the region of the analog power input rails (V_{DD} , GND) and allow the analog input voltage to swing from $GND - 0.3V$ to $V_{DD} + 0.3V$ without damaging the device. Input voltages beyond $GND - 0.3V$ and $V_{DD} + 0.3V$ forward bias the internal protection diodes. Limit the forward diode current to less than 50mA to avoid damage to the MAX11321–MAX11328.

ECHO

When writing to the ADC Configuration register, set ECHO to 1 in ADC Configuration register to echo back the configuration data onto DOUT at time $n+1$ (Figure 8, Table 6).

Scan Modes

The MAX11321–MAX11328 feature nine scan modes (Table 3).

Manual Mode

The next channel to be selected is identified in each SPI frame. The conversion results are sent out in the next frame. The manual mode works with the external clock only. The FIFO is unused.

Repeat Mode

Repeat scanning channel N for number of times and store all the conversion results in the FIFO. The number of scans is programmed in the ADC Configuration register. The repeat mode works with the internal clock only.

Custom_Int and Custom_Ext

In Custom_Int and Custom_Ext modes, the device scans preprogrammed channels in ascending order. The channels to be scanned in sequence are programmed in the Custom Scan0 or Custom Scan1 registers (see Table 12 and Table 13). A new I/P MUX is selected every frame on the thirteenth falling edge of SCLK. Custom_Int works with the internal clock. Custom_Ext works with the external clock.

Standard_Int and Standard_Ext

In Standard_Int and Standard_Ext modes, the device scans channels 0 through N in ascending order where N is the last channel specified in the ADC Mode Control register. A new I/P MUX is selected every frame on the thirteenth falling edge of SCLK. Standard_Int works with the internal clock. Standard_Ext works with the external clock.

Upper_Int and Upper_Ext

In Upper_Int and Upper_Ext modes, the device scans channels N through 15/11/7/3 in ascending order where N is the first channel specified in the ADC Mode Control register. A new I/P MUX is selected every frame on the thirteenth falling edge of SCLK. Upper_Int works with the internal clock. Upper_Ext works with the external clock.

SampleSet

The SampleSet mode of operation allows the definition of a unique channel sequence combination with maximum length of 256. SampleSet is supported only in the external clock mode. SampleSet is ideally suited for multichannel measurement applications where some analog inputs must be converted more often than others.

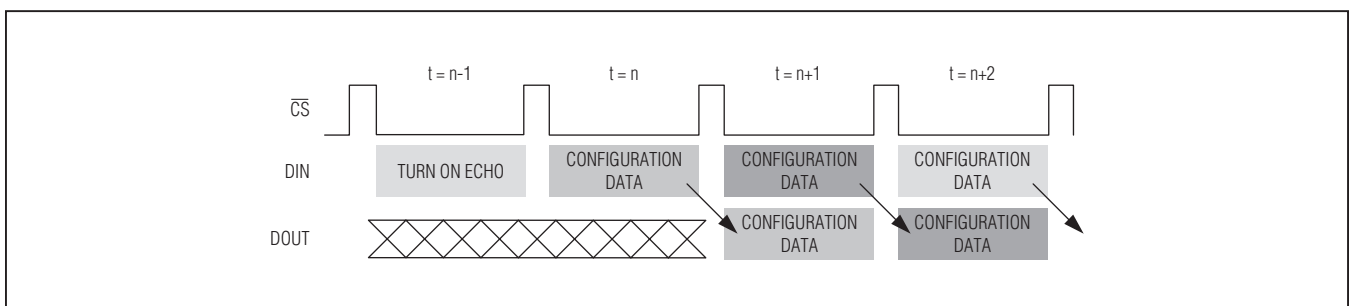

Figure 8. Echo Back the Configuration Data

MAX11321–MAX11328

1MSPS, 10-/12-Bit, 4-/8-/16-Channel ADCs with Post-Mux External Signal Conditioning Access

The SampleSet approach provides greater sequencing flexibility for multichannel applications while alleviating significant microcontroller communication overhead. SampleSet technology allows the user to exploit available ADC input bandwidth without need for constant communication between the ADC and controlling unit. The user may define and load a unique sequencing pattern into

the ADC allowing both high- and low-frequency inputs to be converted appropriately without interface activity. With the unique sequence loaded into ADC memory, the pattern may be repeated indefinitely or changed at any time.

For example, the maximum throughput of MAX11321–MAX11328 is 1MSPS. Traditional ADC scan modes allow

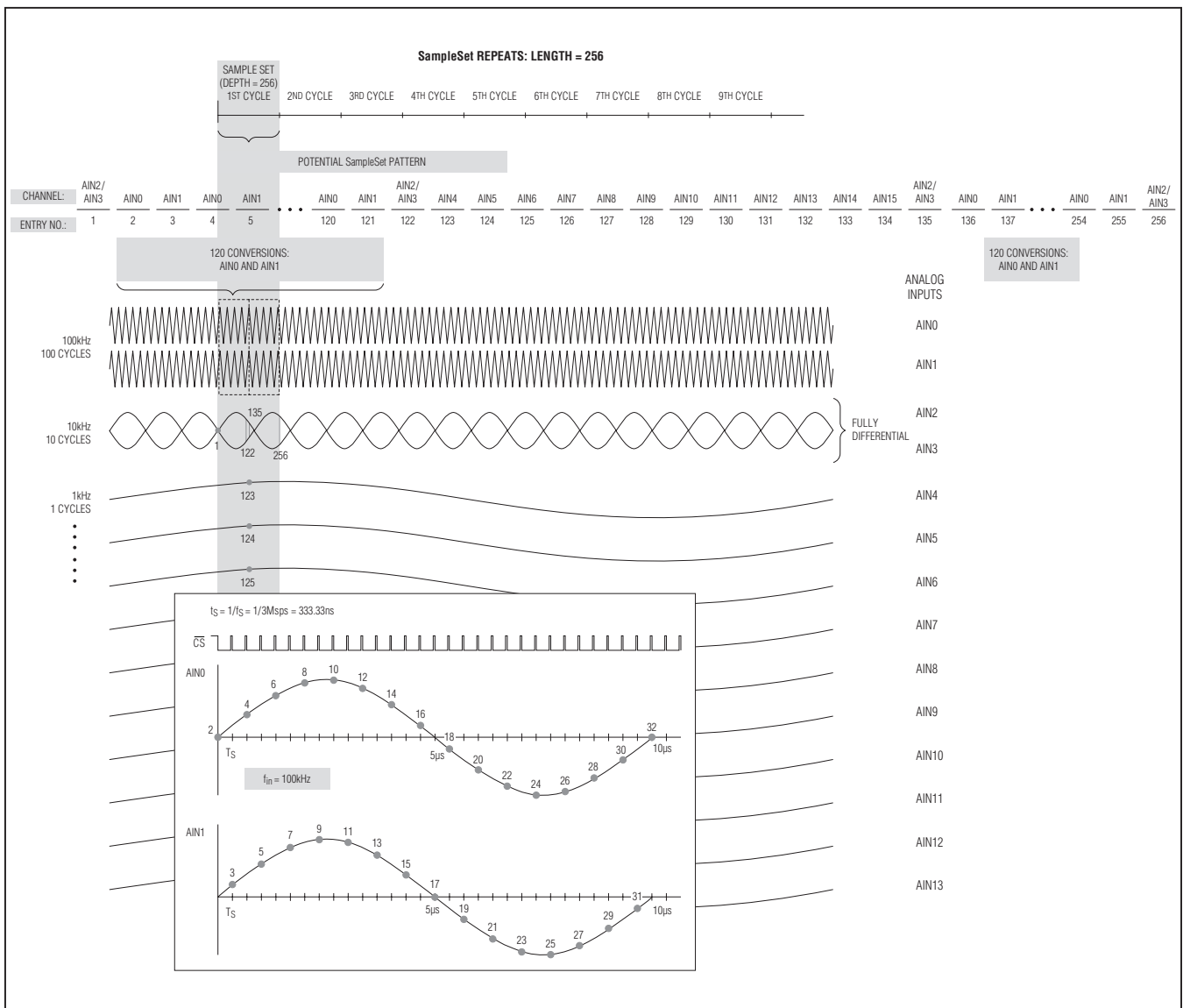

Figure 9. SampleSet Use-Model Example

MAX11321–MAX11328

1Msps, 10-/12-Bit, 4-/8-/16-Channel ADCs with Post-Mux External Signal Conditioning Access

up to 16-channel conversions in ascending order. In this case, the effective throughput per channel is 1Msps/16 channel or 62.5ksps. The maximum input frequency that the ADC can resolve (Nyquist Theorem) is 31.25kHz. If all 16 channels must be measured, with some channels having greater than 31.25kHz input frequency, the user must revert back to manual mode requiring constant communication on the serial interface. SampleSet technology solves this problem. [Figure 9](#) provides a SampleSet use-model example.

Averaging Mode

In averaging mode, the device performs the specified number of conversions and returns the average for each requested result in the FIFO. The averaging mode works with internal clock only.

Scan Modes and Unipolar/Bipolar Setting

When the Unipolar or Bipolar registers are configured as pseudo-differential or fully differential, the analog input pairs are repeated in this automated mode. For example, if N is set to 15 to scan all 16 channels and all analog input pairs are configured for fully-differential conversion, the ADC converts the channels twice. In this case, the user may avoid dual conversions on input pairs by implementing Manual mode or using Custom_Int or Custom_Ext scan modes and only scan even (or odd) channels (e.g. 0, 2, 4).

Table 1. Register Access and Control

REGISTER NAME	REGISTER IDENTIFICATION CODE					DIN ≡ DATA INPUTS
	BIT 15	BIT 14	BIT 13	BIT 12	BIT 11	BIT [10:0]
ADC Mode Control	0	DIN	DIN	DIN	DIN	DIN
ADC Configuration	1	0	0	0	0	DIN
Unipolar	1	0	0	0	1	DIN
Bipolar	1	0	0	1	0	DIN
RANGE	1	0	0	1	1	DIN
Custom Scan0	1	0	1	0	0	DIN
Custom Scan1	1	0	1	0	1	DIN
SampleSet	1	0	1	1	0	DIN
Reserved. Do not use.	1	1	1	1	1	DIN

Table 2. ADC Mode Control Register

BIT NAME	BIT	DEFAULT STATE	FUNCTION		
REG_CNTL	15	0	Set to 0 to select the ADC Mode Control register		
SCAN[3:0]	14:11	0001	ADC Scan Control register (Table 3)		
CHSEL[3:0]	10:7	0000	Analog Input Channel Select register (Table 4). See Table 3 to determine which modes use CHSEL[3:0] for the channel scan instruction.		
RESET[1:0]	6:5	00	RESET1	RESET0	FUNCTION
			0	0	No reset
			0	1	Reset the FIFO only (resets to zero)
			1	0	Reset all registers to default settings (includes FIFO)
			1	1	Unused

MAX11321–MAX11328

1MSPS, 10-/12-Bit, 4-/8-/16-Channel ADCs with Post-Mux External Signal Conditioning Access

Table 2. ADC Mode Control Register (continued)

BIT NAME	BIT	DEFAULT STATE	FUNCTION
PM[1:0]	4:3	00	Power Management Modes (Table 5). In external clock mode, PM[1:0] selects between normal mode and various power-down modes of operation.
CHAN_ID	2	0	External Clock Mode. Channel address is always present in internal clock mode. Set to 1, DOUT is a 16-bit data word containing a 4-bit channel address, followed by a 12-bit conversion result led by the MSB.
SWCNV	1	0	Set to 1 to initiate conversions with the rising edge of \overline{CS} instead of cycling \overline{CNVST} (internal clock mode only). This bit is used for the internal clock mode only and must be reasserted in the ADC mode control, if another conversion is desired.
—	0	0	Unused

Table 3. ADC Scan Control

SCAN3	SCAN2	SCAN1	SCAN0	MODE NAME	FUNCTION
0	0	0	0	Null	Continue to operate in the previously selected mode. Ignore data on bits [10:0]. This feature is provided so that DIN can be held low when no changes are required in the ADC Mode Control register. Bits [6:3, 1] can be still written without changing the scan mode properties.
0	0	0	1	Manual	The next channel to be selected is identified in each SPI frame. The conversion results are sent out in the next frame. Clock mode: External clock only Channel scan/sequence: Single channel per frame Channel selection: See Table 4, CHSEL[3:0] Averaging: No
0	0	1	0	Repeat	Scans channel N repeatedly. The FIFO stores 4, 8, 12, or 16 conversion results for channel N. Clock mode: Internal clock only Channel scan/sequence: Single channel per frame Channel selection: See Table 4, CHSEL[3:0] Averaging: Can be enabled
0	0	1	1	Standard_Int	Scans channels 0 through N. The FIFO stores N conversion results. Clock mode: Internal clock Channel scan/sequence: N channels in ascending order Channel selection: See Table 4, CHSEL[3:0] determines channel N Averaging: Can be enabled

MAX11321–MAX11328

1MSPS, 10-/12-Bit, 4-/8-/16-Channel ADCs with Post-Mux External Signal Conditioning Access

Table 3. ADC Scan Control (continued)

SCAN3	SCAN2	SCAN1	SCAN0	MODE NAME	FUNCTION	
0	1	0	0	Standard_Ext	Scans channels 0 through N	
					Clock mode: External clock only	
					Channel scan/sequence: N channels in ascending order	
					Channel selection: See Table 4, CHSEL[3:0] determines channel N	
					Averaging: No	
0	1	0	1	Upper_Int	Scans channel N through the highest numbered channel. The FIFO stores X conversion results where:	
					X = Channel 16–N	16-channel devices
					X = Channel 8–N	8-channel devices
					Clock mode: Internal clock only	
					Channel scan/sequence: Channel N through the highest numbered channel in ascending order	
					Channel selection: See Table 4, CHSEL[3:0] determines channel N	
					Averaging: Can be enabled	
0	1	1	0	Upper_Ext	Scans channel N through the highest numbered channel	
					Clock mode: External clock only	
					Channel scan/sequence: Channel N through the highest numbered channel in ascending order	
					Channel selection: See Table 4, CHSEL[3:0] determines channel N	
					Averaging: No	
0	1	1	1	Custom_Int	Scans preprogrammed channels in ascending order. The FIFO stores conversion results for this unique channel sequence.	
					Clock mode: Internal clock only	
					Channel scan/sequence: Unique ascending channel sequence	
					Maximum depth: 16 conversions	
					Channel selection: See Table 12, Custom Scan0 register and Table 13, Custom Scan1 register	
					Averaging: Can be enabled	
1	0	0	0	Custom_Ext	Scans preprogrammed channels in ascending order	
					Clock mode: External clock only	
					Channel scan/sequence: Unique ascending channel sequence	
					Maximum depth: 16 conversions	
					Channel selection: See Table 12, Custom Scan0 register and Table 13, Custom Scan1 register	
					Averaging: No	

MAX11321–MAX11328

1MSPS, 10-/12-Bit, 4-/8-/16-Channel ADCs with Post-Mux External Signal Conditioning Access

Table 3. ADC Scan Control (continued)

SCAN3	SCAN2	SCAN1	SCAN0	MODE NAME	FUNCTION
1	0	0	1	SampleSet	Scans preprogrammed channel sequence with maximum length of 256. There is no restriction on the channel pattern.
					Clock mode: External clock only
					Channel scan/sequence: Unique channel sequence
					Maximum depth: 256 conversions
					Channel Selection: See Table 4
					Averaging: No
1	0	1	0	Null	Continue to operate in the previously selected mode. Ignore data on bits [10:0].
1	0	1	1	Null	Continue to operate in the previously selected mode. Ignore data on bits [10:0].
1	1	0	0	Null	Continue to operate in the previously selected mode. Ignore data on bits [10:0].
1	1	0	1	Null	Continue to operate in the previously selected mode. Ignore data on bits [10:0].
1	1	1	0	Null	Continue to operate in the previously selected mode. Ignore data on bits [10:0].
1	1	1	1	Null	Continue to operate in the previously selected mode. Ignore data on bits [10:0].

Table 4. Analog Input Channel Select

CHSEL3	CHSEL2	CHSEL1	CHSEL0	SELECTED CHANNEL (N)
0	0	0	0	AIN0
0	0	0	1	AIN1
0	0	1	0	AIN2
0	0	1	1	AIN3
0	1	0	0	AIN4
0	1	0	1	AIN5
0	1	1	0	AIN6
0	1	1	1	AIN7
1	0	0	0	AIN8
1	0	0	1	AIN9
1	0	1	0	AIN10
1	0	1	1	AIN11
1	1	0	0	AIN12
1	1	0	1	AIN13
1	1	1	0	AIN14
1	1	1	1	AIN15

MAX11321–MAX11328

1MSPs, 10-/12-Bit, 4-/8-/16-Channel ADCs with Post-Mux External Signal Conditioning Access

Register Descriptions

The MAX11321–MAX11328 communicate between the internal registers and the external circuitry through the SPI/QSPI-compatible serial interface. [Table 1](#) details the register access and control. [Table 2](#) through [Table 14](#) detail the various functions and configurations.

For ADC mode control, set bit 15 of the register code identification to zero. The ADC Mode Control register determines when and under what scan condition the ADC operates.

To set the ADC data configuration, set the bit 15 of the register code identification to one.

Power-Down Mode

The MAX11321–MAX11328 feature three power-down modes.

Static Shutdown

The devices shut down when the SPM bits in the ADC Configuration register are asserted ([Table 6](#)). There are two shutdown options:

- Full shutdown where all circuitry is shutdown.
- Partial shutdown where all circuitry is powered down except for the internal bias generator.

AutoShutdown with External Clock Mode

When the PM_ bits in the ADC Mode Control register are asserted ([Table 5](#)), the device shuts down at the rising edge of \overline{CS} in the next frame. The device powers up again at the following falling edge of \overline{CS} . There are two available options:

- AutoShutdown where all circuitry is shutdown.
- AutoStandby where all circuitry are powered down except for the internal bias generator.

AutoShutdown with Internal Clock Mode

The device shuts down after all conversions are completed. The device powers up again at the next falling edge of \overline{CNVST} or at the rising edge of \overline{CS} after the SWCNV bit is asserted.

Table 5. Power Management Modes

PM1	PM0	MODE	FUNCTION
0	0	Normal	All circuitry is fully powered up at all times.
0	1	AutoShutdown	The device enters full shutdown mode at the end of each conversion. All circuitry is powered down. The device powers up following the falling edge of \overline{CS} . It takes 2 cycles before valid conversions take place. The information in the registers is retained.
1	0	AutoStandby	The device powers down all circuitry except for the internal bias generator. The part powers up following the falling edge of \overline{CS} . It takes 2 cycles before valid conversions take place. The information in the registers is retained.
1	1	—	Unused.

Table 6. ADC Configuration Register

BIT NAME	BIT	DEFAULT STATE	FUNCTION		
CONFIG_SETUP	15:11	N/A	Set to 10000 to select the ADC Configuration register.		
REFSEL	10	0	REFSEL	VOLTAGE REFERENCE	REF- CONFIGURATION
			0	External single-ended	AIN15 (for the 16-channel devices)
			1	External differential	REF-
AVGON	9	0	Set to 1 to turn averaging on. Valid for internal clock mode only. Set to 0 to turn averaging off.		

MAX11321–MAX11328

1MSPS, 10-/12-Bit, 4-/8-/16-Channel ADCs with Post-Mux External Signal Conditioning Access

Table 6. ADC Configuration Register (continued)

BIT NAME	BIT	DEFAULT STATE	FUNCTION			
NAVG[1:0]	8:7	00	Valid for internal clock mode only.			
			AVGON	NAVG1	NAVG0	FUNCTION
			0	X	X	Performs 1 conversion for each requested result.
			1	0	0	Performs 4 conversions and returns the average for each requested result.
			1	0	1	Performs 8 conversions and returns the average for each requested result.
			1	1	0	Performs 16 conversions and returns the average for each requested result.
NSCAN[1:0]	6:5	00	Scans channel N and returns 4, 8, 12, or 16 results. Valid for repeat mode only.			
			NSCAN1	NSCAN0	FUNCTION	
			0	0	Scans channel N and returns 4 results.	
			0	1	Scans channel N and returns 8 results.	
			1	0	Scans channel N and returns 12 results.	
SPM[1:0]	4:3	00	Static power-down modes			
			SPM1	SPM0	MODE	FUNCTION
			0	0	Normal	All circuitry is fully powered up at all times.
			0	1	Full Shutdown	All circuitry is powered down. The information in the registers is retained.
			1	0	Partial Shutdown	All circuitry is powered down except for the reference and reference buffer. The information in the registers is retained.
ECHO	2	0	Set to 0 to disable the instruction echo on DOUT. Set to 1 to echo back the DIN instruction given at time = n onto the DOUT line at time = n + 1. It takes 1 full cycle for the echoing to begin (Figure 8).			
			—	1:0	0	Unused

MAX11321–MAX11328

1Msps, 10-/12-Bit, 4-/8-/16-Channel ADCs with Post-Mux External Signal Conditioning Access

Table 7. RANGE Register (RANGE Settings Only Applies to Bipolar Fully Differential Analog Input Configurations)

BIT NAME	BIT	DEFAULT STATE	FUNCTION
RANGE_SETUP	15:11	N/A	Set to 10011 to select the RANGE register
RANGE0/1	10	0	Set to 0 for AIN0/1: $\pm V_{REF+}/2$, $f_S = V_{REF+} - V_{REF-}$ Set to 1 for AIN0/1: $\pm V_{REF+}$, $f_S = 2(V_{REF+} - V_{REF-})$
RANGE2/3	9	0	Set to 0 for AIN2/3: $\pm V_{REF+}/2$, $f_S = V_{REF+} - V_{REF-}$ Set to 1 for AIN2/3: $\pm V_{REF+}$, $f_S = 2(V_{REF+} - V_{REF-})$
RANGE4/5	8	0	Set to 0 for AIN4/5: $\pm V_{REF+}/2$, $f_S = V_{REF+} - V_{REF-}$ Set to 1 for AIN4/5: $\pm V_{REF+}$, $f_S = 2(V_{REF+} - V_{REF-})$
RANGE6/7	7	0	Set to 0 for AIN6/7: $\pm V_{REF+}/2$, $f_S = V_{REF+} - V_{REF-}$ Set to 1 for AIN6/7: $\pm V_{REF+}$, $f_S = 2(V_{REF+} - V_{REF-})$
RANGE8/9	6	0	Set to 0 for AIN8/9: $\pm V_{REF+}/2$, $f_S = V_{REF+} - V_{REF-}$ Set to 1 for AIN8/9: $\pm V_{REF+}$, $f_S = 2(V_{REF+} - V_{REF-})$
RANGE10/11	5	0	Set to 0 for AIN10/11: $\pm V_{REF+}/2$, $f_S = V_{REF+} - V_{REF-}$ Set to 1 for AIN10/11: $\pm V_{REF+}$, $f_S = 2(V_{REF+} - V_{REF-})$
RANGE12/13	4	0	Set to 0 for AIN12/13: $\pm V_{REF+}/2$, $f_S = V_{REF+} - V_{REF-}$ Set to 1 for AIN12/13: $\pm V_{REF+}$, $f_S = 2(V_{REF+} - V_{REF-})$
RANGE14/15	3	0	Set to 0 for AIN14/15: $\pm V_{REF+}/2$, $f_S = V_{REF+} - V_{REF-}$ Set to 1 for AIN14/15: $\pm V_{REF+}$, $f_S = 2(V_{REF+} - V_{REF-})$
—	2:0	000	Unused

ADC Output as a Function of Unipolar and Bipolar Modes

The ADC Scan Control register (Table 3) determines the ADC mode of operation. The Unipolar and Bipolar registers in Table 10 and Table 11 determine output coding and whether input configuration is single-ended or fully differential.

Table 9 details the conversion output for analog inputs, AIN0 and AIN1. The truth table is consistent for any other valid input pairs (AINn/AINn+1). Table 8 shows the applicable input signal format with respect to analog input configurations.

CHSEL[3:0] is used for MANUAL, REPEAT, STANDARD_EXT, STANDARD_INT, UPPER_EXT, UPPER_INT modes of operation. CHSCAN[15:0] is used for CUSTOM_EXT and CUSTOM_INT modes of operation.

SampleSet Mode of Operation

The SampleSet register stores the unique channel sequence length. The sequence pattern is comprised of up to 256 unique single-ended and/or differential conversions with any order or pattern.

Patterns are assembled in 4-bit channel identifier nibbles as described in Table 4. Figure 10 presents the SampleSet timing diagram. Note that two \overline{CS} frames are required to configure the SampleSet functionality. The first frame indicates the sequence length. The second frame is used to encode the channel sequence pattern.

After the SampleSet register has been coded (Table 14), by the next falling edge of \overline{CS} , the new SampleSet pattern is activated (Figure 10). If the pattern length is less than SEQ_LENGTH, the remaining channels default to AIN0. If the select pattern length is greater than SEQ_LENGTH, the additional data is ignored as the ADC waits for the rising edge of \overline{CS} . If \overline{CS} is asserted in the middle of a nibble, the full nibble defaults to AIN0.

Upon receiving the SampleSet pattern, the user can set the ADC Mode Control register to begin the conversion process where data readout begins with the first SampleSet entry. While the last conversion result is read, the ADC can be instructed to enter AutoShutdown, if desired. If the user wishes to change the SampleSet length, a new pattern must be loaded into the ADC as described in Figure 10.

MAX11321–MAX11328

1MSPS, 10-/12-Bit, 4-/8-/16-Channel ADCs with Post-Mux External Signal Conditioning Access

Table 8. Analog Input Configuration and Unipolar/Bipolar Waveforms

ANALOG INPUT CONFIGURATION		SUPPORTED WAVEFORMS		UNIPOLAR/BIPOLAR REGISTER SETTING
		REFSEL = 0	REFSEL = 1	
Single-Ended	Unipolar (Binary Coding)			Table 10. Unipolar Register: Set desired channel(s) to 0 or PDIFF_COM to 1. Counterpart Register Table 11. Bipolar Register: Set desired channel(s) to 0.
				Table 10. Unipolar Register: Set desired channel(s) to 1. Counterpart Register Table 11. Bipolar Register: Set desired channel(s) to 0.
Fully Differential	Bipolar (2's Complement)			Table 11. Bipolar Register: Set desired channel(s) to 1. Counterpart Register Table 10. Unipolar Register: Set desired channel(s) to 0.

Table 9. ADC Output as a Function of Unipolar/Bipolar Register Settings

CHANNEL SELECTION	UNIPOLAR REGISTER		BIPOLAR REGISTER		FUNCTION
	BIT NAME	UCH0/1	PDIFF_COM	BCH0/1	
AIN0 Selection: CHSEL[3:0] = 0000 CHSCAN0 = 1		0	0	0	AIN0 (binary, unipolar)
		0	0	1	AIN0/1 pair (two's complement, bipolar)
		1	0	0	AIN0/1 pair (binary, unipolar)
		1	0	1	AIN0/1 pair (binary, unipolar); Unipolar register takes precedence
		X	1	X	AIN0 referred to REF-/AIN15 (binary, unipolar)
AIN1 Selection: CHSEL[3:0] = 0001 CHSCAN1 = 1		0	0	0	AIN1 (binary, unipolar)
		0	0	1	AIN0/1 pair (two's complement, bipolar)
		1	0	0	AIN0/1 pair (binary, unipolar)
		1	0	1	AIN0/1 pair (binary, unipolar), Unipolar register takes precedence
		X	1	X	AIN1 referred to REF-/AIN15 (binary, unipolar)

MAX11321–MAX11328

1MSPs, 10-/12-Bit, 4-/8-/16-Channel ADCs with Post-Mux External Signal Conditioning Access

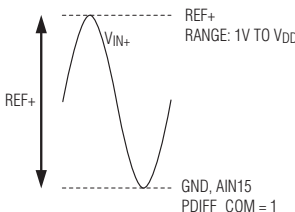
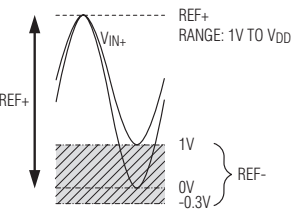
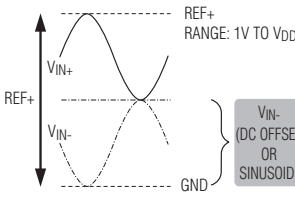
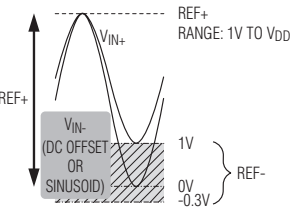
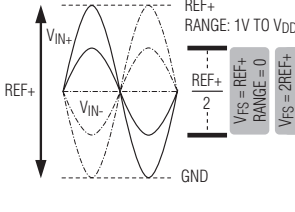
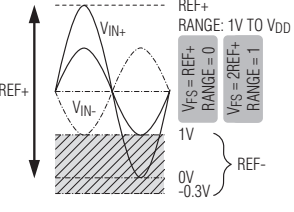
Table 10. Unipolar Register

BIT NAME	BIT	DEFAULT STATE	FUNCTION
UNI_SETUP	15:11	—	Set to 10001 to select the Unipolar register.
UCH0/1	10	0	Set to 1 to configure AIN0 and AIN1 for pseudo-differential conversion. Set to 0 to configure AIN0 and AIN1 for single-ended conversion.
UCH2/3	9	0	Set to 1 to configure AIN2 and AIN3 for pseudo-differential conversion. Set to 0 to configure AIN2 and AIN3 for single-ended conversion.
UCH4/5	8	0	Set to 1 to configure AIN4 and AIN5 for pseudo-differential conversion. Set to 0 to configure AIN4 and AIN5 for single-ended conversion.
UCH6/7	7	0	Set to 1 to configure AIN6 and AIN7 for pseudo-differential conversion. Set to 0 to configure AIN6 and AIN7 for single-ended conversion.
UCH8/9	6	0	Set to 1 to configure AIN8 and AIN9 for pseudo-differential conversion. Set to 0 to configure AIN8 and AIN9 for single-ended conversion.
UCH10/11	5	0	Set to 1 to configure AIN10 and AIN11 for pseudo-differential conversion. Set to 0 to configure AIN10 and AIN11 for single-ended conversion.
UCH12/13	4	0	Set to 1 to configure AIN12 and AIN13 for pseudo-differential conversion. Set to 0 to configure AIN12 and AIN13 for single-ended conversion.
UCH14/15	3	0	Set to 1 to configure AIN14 and AIN15 for pseudo-differential conversion. Set to 0 to configure AIN14 and AIN15 for single-ended conversion.
PDIFC_COM	2	0	Set to 1 to configure AIN0–AIN14 to be referenced to one common DC voltage on the REF-/AIN15. Set to 0 to disable the 15:1 pseudo differential mode.
—	1:0	000	Unused.

Table 11. Bipolar Register

BIT NAME	BIT	DEFAULT STATE	FUNCTION
BIP_SETUP	15:11	—	Set to 10010 to select the Bipolar register.
BCH0/1	10	0	Set to 1 to configure AIN0 and AIN1 for bipolar fully differential conversion. Set to 0 to configure AIN0 and AIN1 for unipolar conversion mode.
BCH2/3	9	0	Set to 1 to configure AIN2 and AIN3 for bipolar fully differential conversion. Set to 0 to configure AIN2 and AIN3 for unipolar conversion mode.
BCH4/5	8	0	Set to 1 to configure AIN4 and AIN5 for bipolar fully differential conversion. Set to 0 to configure AIN4 and AIN5 for unipolar conversion mode.
BCH6/7	7	0	Set to 1 to configure AIN6 and AIN7 for bipolar fully differential conversion. Set to 0 to configure AIN6 and AIN7 for unipolar conversion mode.
BCH8/9	6	0	Set to 1 to configure AIN8 and AIN9 for bipolar fully differential conversion. Set to 0 to configure AIN8 and AIN9 for unipolar conversion mode.
BCH10/11	5	0	Set to 1 to configure AIN10 and AIN11 for bipolar fully differential conversion. Set to 0 to configure AIN10 and AIN11 for unipolar conversion mode.
BCH12/13	4	0	Set to 1 to configure AIN12 and AIN13 for bipolar fully differential conversion. Set to 0 to configure AIN12 and AIN13 for unipolar conversion mode.
BCH14/15	3	0	Set to 1 to configure AIN14 and AIN15 for bipolar fully differential conversion. Set to 0 to configure AIN14 and AIN15 for unipolar conversion mode.
—	2:0	000	Unused.

MAX11321–MAX11328

1MSPS, 10-/12-Bit, 4-/8-/16-Channel ADCs with Post-Mux External Signal Conditioning Access

Table 12. Custom Scan0 Register

BIT NAME	BIT	DEFAULT STATE	FUNCTION
CUST_SCAN0	15:11	—	Set to 10100 to select the Custom Scan0 register.
CHSCAN15	10	0	Set to 1 to scan AIN15. Set to 0 to omit AIN15.
CHSCAN14	9	0	Set to 1 to scan AIN14. Set to 0 to omit AIN14.
CHSCAN13	8	0	Set to 1 to scan AIN13. Set to 0 to omit AIN13.
CHSCAN12	7	0	Set to 1 to scan AIN12. Set to 0 to omit AIN12.
CHSCAN11	6	0	Set to 1 to scan AIN11. Set to 0 to omit AIN11.
CHSCAN10	5	0	Set to 1 to scan AIN10. Set to 0 to omit AIN10.
CHSCAN9	4	0	Set to 1 to scan AIN9. Set to 0 to omit AIN9.
CHSCAN8	3	0	Set to 1 to scan AIN8. Set to 0 to omit AIN8.
—	2:0	000	Unused.

Table 13. Custom Scan1 Register

BIT NAME	BIT	DEFAULT STATE	FUNCTION
CUST_SCAN1	15:11	—	Set to 10101 to select the Custom Scan1 register.
CHSCAN7	10	0	Set to 1 to scan AIN7. Set to 0 to omit AIN7.
CHSCAN6	9	0	Set to 1 to scan AIN6. Set to 0 to omit AIN6.
CHSCAN5	8	0	Set to 1 to scan AIN5. Set to 0 to omit AIN5.
CHSCAN4	7	0	Set to 1 to scan AIN4. Set to 0 to omit AIN4.
CHSCAN3	6	0	Set to 1 to scan AIN3. Set to 0 to omit AIN3.
CHSCAN2	5	0	Set to 1 to scan AIN2. Set to 0 to omit AIN2.
CHSCAN1	4	0	Set to 1 to scan AIN1. Set to 0 to omit AIN1.
CHSCAN0	3	0	Set to 1 to scan AIN0. Set to 0 to omit AIN0.
—	2:0	000	Unused.

Table 14. SampleSet Register

BIT NAME	BIT	DEFAULT STATE	FUNCTION
SMPL_SET	15:11	—	Set to 10110 to select the SampleSet register.
SEQ_LENGTH	10:3	00000000	8-bit binary word indicating desired sequence length. The equation is: Sequence length = SEQ_LENGTH + 1 00000000 = Sequence length = 1 11111111 = Sequence length = 256 Coding: Straight binary Maximum length: 256 ADC conversions
—	2:0	—	Unused.

MAX11321–MAX11328

1MSPS, 10-/12-Bit, 4-/8-/16-Channel ADCs with Post-Mux External Signal Conditioning Access

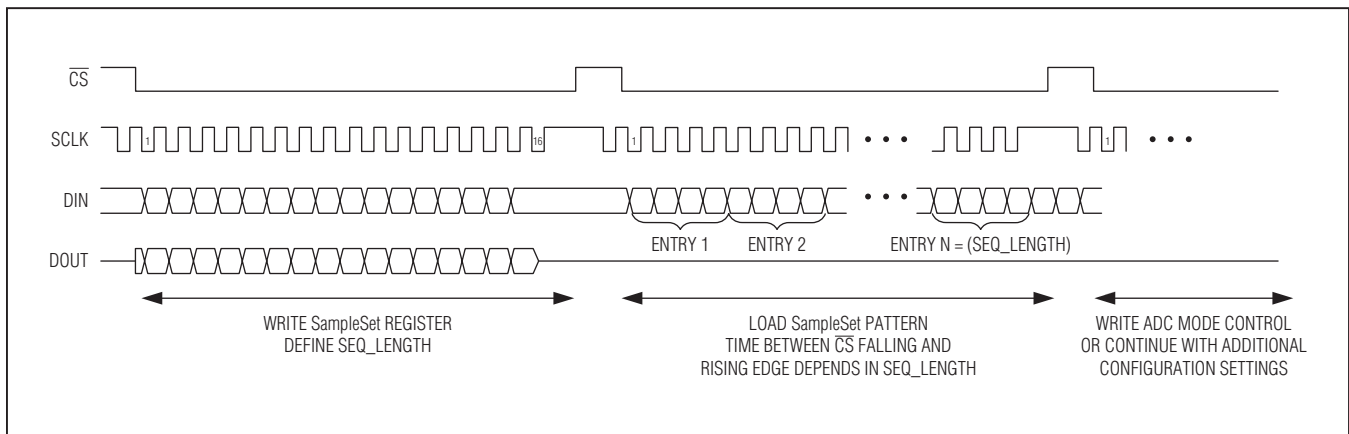

Figure 10. SampleSet Timing Diagram

Applications Information

How to Program Modes

- 1) Configure the ADC (set the MSB on DIN to 1).
- 2) Program ADC mode control (set the MSB on DIN to 0) to begin the conversion process or to control power management features.
 - If ADC mode control is written during a conversion sequence, the ADC finishes the present conversion and at the next falling edge of CS initiates its new instruction.
 - If configuration data (MSB on DIN is a 1) is written during a conversion sequence, the ADC finishes the present conversion in the existing scan mode. However, data on DOUT is not valid in following frames until a new ADC mode control instruction is coded.

Programming Sequence Flow Chart

See [Figure 11](#) for programming sequence.

Layout, Grounding, and Bypassing

For best performance, use PCBs with a solid ground plane. Ensure that digital and analog signal lines are separated from each other. Do not run analog and digital (especially clock) lines parallel to one another or digital lines underneath the ADC package. Noise in the V_{DD} ,

OVDD, and REF affects the ADC's performance. Bypass the V_{DD} , OVDD, and REF to ground with 0.1 μ F and 10 μ F bypass capacitors. Minimize capacitor lead and trace lengths for best supply-noise rejection.

Choosing an Input Amplifier

It is important to match the settling time of the input amplifier to the acquisition time of the ADC. The conversion results are accurate when the ADC samples the input signal for an interval longer than the input signal's worst-case settling time. By definition, settling time is the interval between the application of an input voltage step and the point at which the output signal reaches and stays within a given error band centered on the resulting steady-state amplifier output level. The ADC input sampling capacitor charges during the sampling cycle, referred to as the acquisition period. During this acquisition period, the settling time is affected by the input resistance and the input sampling capacitance. This error can be estimated by looking at the settling of an RC time constant using the input capacitance and the source impedance over the acquisition time period. [Figure 13](#) shows a typical application circuit. The MAX4430, offering a settling time of 37ns at 16-bit resolution, is an excellent choice for this application.

[Table 15](#) lists several recommended operational amplifiers for MAX11321–MAX11328.

MAX11321–MAX11328

1Mps, 10-/12-Bit, 4-/8-/16-Channel ADCs with Post-Mux External Signal Conditioning Access

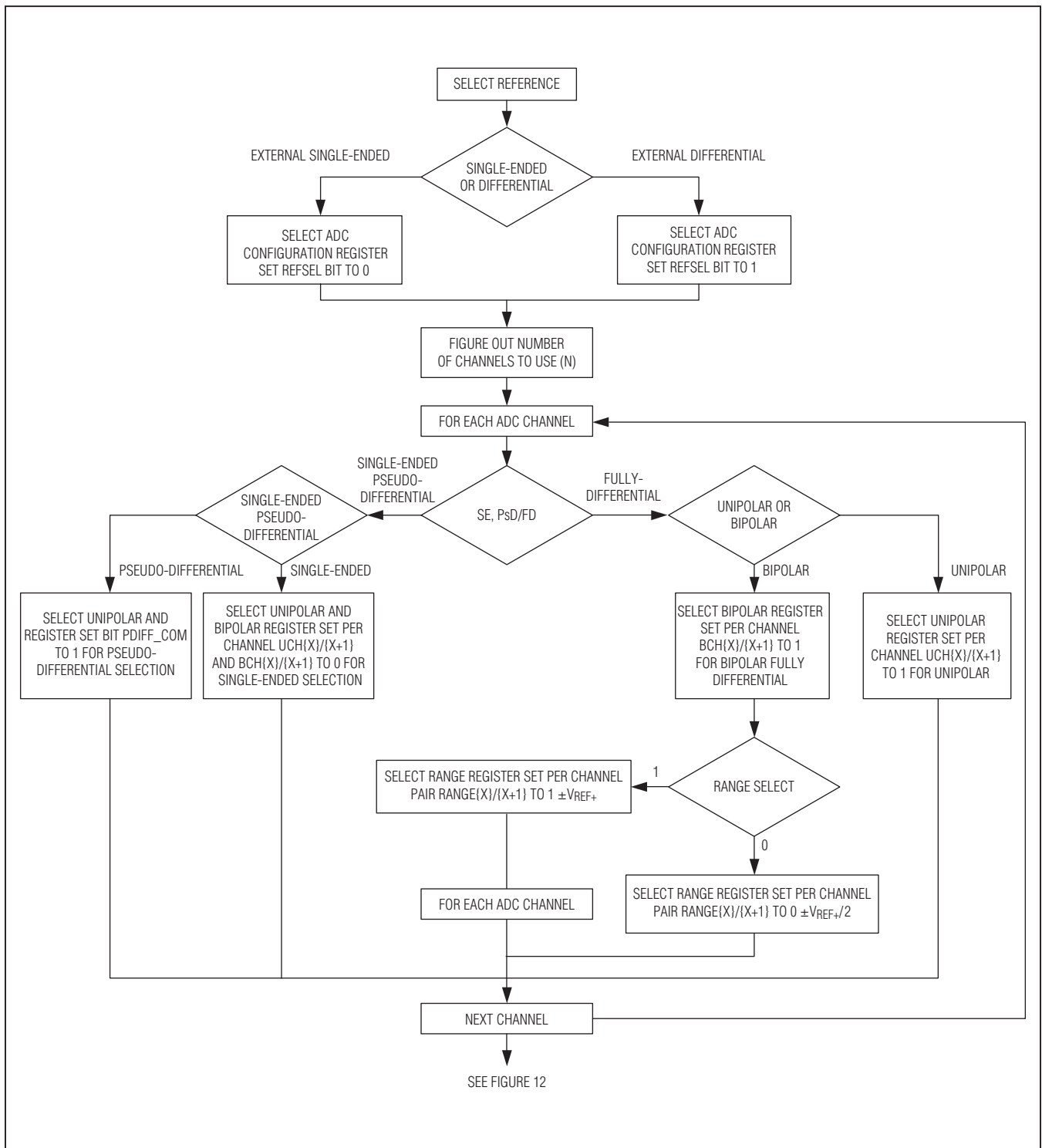

Figure 11. ADC Programming Sequence

MAX11321–MAX11328

1Mps, 10-/12-Bit, 4-/8-/16-Channel ADCs with Post-Mux External Signal Conditioning Access

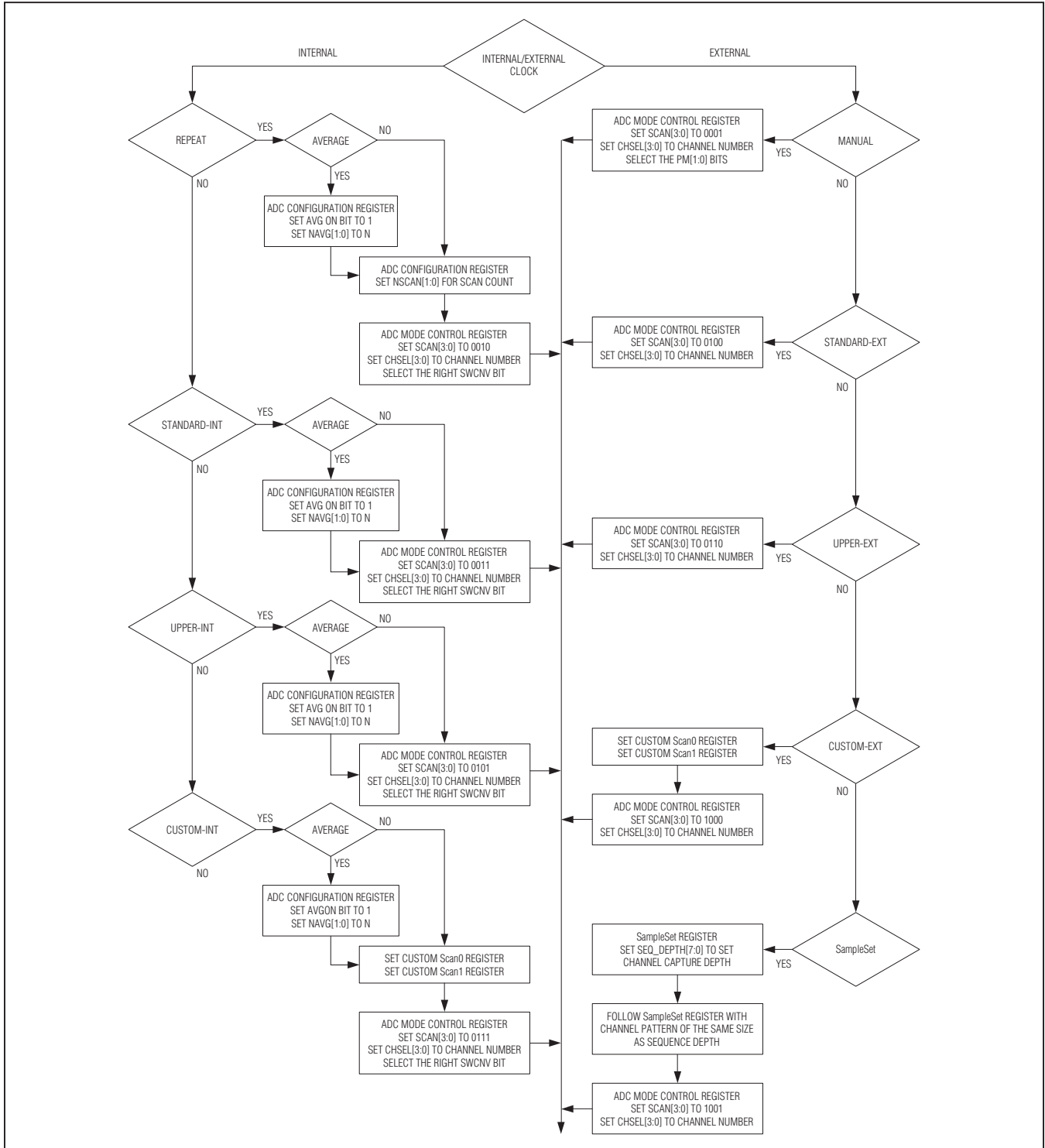

Figure 12. ADC Mode Select Programming Sequence

MAX11321–MAX11328

1Msps, 10-/12-Bit, 4-/8-/16-Channel ADCs with Post-Mux External Signal Conditioning Access

Definitions

Integral Nonlinearity

Integral nonlinearity (INL) is the deviation of the values on an actual transfer function from a straight line. This straight line can be either a best-straight-line fit or a line drawn between the end points of the transfer function, once offset and gain errors have been nulled. The static linearity parameters for the MAX11321–MAX11328 are measured using the end-points method.

Differential Nonlinearity

Differential nonlinearity (DNL) is the difference between an actual step width and the ideal value of 1 LSB. A DNL error specification of 1 LSB or less guarantees no missing codes and a monotonic transfer function.

Signal-to-Noise Ratio

Signal-to-noise ratio is the ratio of the amplitude of the desired signal to the amplitude of noise signals at a given point in time. The larger the number, the better. The theoretical minimum analog-to-digital noise is caused by quantization error and results directly from the ADC's resolution (N bits):

$$\text{SNR} = (6.02 \times N + 1.76) \text{ dB}$$

In reality, there are other noise sources besides quantization noise, including thermal noise, reference noise, clock jitter, etc. Therefore, SNR is computed by taking the ratio of the RMS signal to the RMS noise, which includes all spectral components minus the fundamental, the first five harmonics, and the DC offset.

Total Harmonic Distortion

Total harmonic distortion (THD) is expressed as:

$$\text{THD} = 20 \times \log \left(\frac{\sqrt{V_2^2 + V_3^2 + V_4^2 + V_5^2}}{V_1} \right)$$

where V_1 is the fundamental amplitude, and V_2 through V_5 are the amplitudes of the 2nd- through 5th-order harmonics.

Spurious-Free Dynamic Range

Spurious-free dynamic range (SFDR) is the ratio of the RMS amplitude of the fundamental (maximum signal component) to the RMS value of the next largest distortion component.

Full-Power Bandwidth

Full-power bandwidth is the frequency at which the input signal amplitude attenuates by 3dB for a full-scale input.

Table 15. Recommended Input Amplifiers

REFERENCE	CHANNELS	TYPICAL APPLICATION
MAX4430	1	Dual supply, low noise, low distortion, high bandwidth
MAX4432	2	Dual supply, low noise, low distortion, high bandwidth
MAX4454	4	Low power, single, supply, low cost
MAX4418	4	Low noise, low power, high bandwidth
MAX44263	2	Low power, precision, CMOS input, rail-to-rail I/O

Table 16. Recommended References

REFERENCE	TYPICAL APPLICATION
MAX6126	Ultra-high precision, ultra-low noise, wide temperature range
MAX6033	Ultra-high precision, low noise, low power, wide temperature range
MAX6043	High precision, wide temperature range
MAX6129B	Low cost, ultra-low power
MAX6003	Low cost, low power

MAX11321–MAX11328

1MSPS, 10-/12-Bit, 4-/8-/16-Channel ADCs with Post-Mux External Signal Conditioning Access

Full-Linear Bandwidth

Full-linear bandwidth is the frequency at which the signal-to-noise plus distortion (SINAD) is more than 70dB (MAX11322/MAX11325/MAX11328).

Intermodulation Distortion

Any device with nonlinearities creates distortion products when two sine waves at two different frequencies (f1 and f2) are input into the device. Intermodulation distortion (IMD) is the total power of the IM2 to IM5 intermodulation products to the Nyquist frequency relative to the total input power of the two input tones, f1 and f2. The individual input tone levels are at -6dBFS.

Ordering Information

PART	PIN-PACKAGE	BITS	SPEED (MSPS)	NO. OF CHANNELS
MAX11321ATJ+	32 TQFN-EP*	10	1	4
MAX11322ATJ+	32 TQFN-EP*	12	1	4
MAX11324ATJ+	32 TQFN-EP*	10	1	8
MAX11325ATJ+	32 TQFN-EP*	12	1	8
MAX11327ATJ+	32 TQFN-EP*	10	1	16
MAX11328ATJ+	32 TQFN-EP*	12	1	16

Note: All devices are specified over the -40°C to +125°C temperature range.

+Denotes a lead(Pb)-free/RoHS-compliant package.

*EP = Exposed pad.

Package Information

For the latest package outline information and land patterns (footprints), go to www.maximintegrated.com/packages. Note that a "+", "#", or "-" in the package code indicates RoHS status only. Package drawings may show a different suffix character, but the drawing pertains to the package regardless of RoHS status.

PACKAGE TYPE	PACKAGE CODE	OUTLINE NO.	LAND PATTERN NO.
32 TQFN-EP	T3255+5	21-0140	90-0013

MAX11321–MAX11328

1Msps, 10-/12-Bit, 4-/8-/16-Channel ADCs with Post-Mux External Signal Conditioning Access

Revision History

REVISION NUMBER	REVISION DATE	DESCRIPTION	PAGES CHANGED
0	9/12	Initial release	—



Maxim cannot assume responsibility for use of any circuitry other than circuitry entirely embodied in a Maxim product. No circuit patent licenses are implied. Maxim reserves the right to change the circuitry and specifications without notice at any time. The parametric values (min and max limits) shown in the Electrical Characteristics table are guaranteed. Other parametric values quoted in this data sheet are provided for guidance.

Maxim Integrated 160 Rio Robles, San Jose, CA 95134 USA 1-408-601-1000

37