

TECHNICAL CHARACTERISTICS

MATERIAL
 INSULATOR: LCP
 FLAMMABILITY RATING: UL94-V0
 COLOR: BLACK
 CONTACT MATERIAL: BRASS
 CONTACT PLATING: GOLD OVERPd-Ni
 CONTACT AREA: 30µ" Pd-Ni+2µ" Gold
 QUALITY CLASS: 10 000 MATING CYCLES

ENVIRONMENTAL
 OPERATING TEMPERATURE: -25°C UP TO +105°C
 COMPLIANCE: LEAD FREE & ROHS

ELECTRICAL
 CURRENT RATING:
 A1,A12,B1 & B12 – ALL CONNECTED TOGETHER: 5 A
 A4,A9,B4 & B9 – ALL CONNECTED TOGETHER: 5 A
 A5 & B5: 1.25 A
 ALL OTHER PINS: 0.25 A

WORKING VOLTAGE: 20 VDC
 WITHSTANDING VOLTAGE: 100 VAC/MIN
 INSULATION RESISTANCE: > 1000 MΩ
 CONTACT RESISTANCE: 30 mΩ MAX

MECHANICAL
 INSERTION FORCE: 5-8 N MAX
 EXTRACTION FORCE: 8-20 N MIN

STANDARD
 CERTIFIED: E323964
 TIP LISTED

SOLDERING
 JEDEC LEAD FREE REFLOW SOLDERING PROCESS

PACKAGING
 TAPE & REEL

X	PCB THICKNESS	A
1	1.00 MM	1.50 MM
3	1.60 MM	1.90 MM

RoHS Compliant			
G			
F			
E			
D			
C			
B	26-JAN-17	UPGRADE	AK
A	17-NOV-15	PDF	AK
REV	DATE	FILE	BY

PROJECTION:

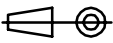

APPROVAL: NPr

GENERAL TOLERANCE
 .X = +/- 0.2
 .XX = +/- 0.15

UNIT: MM
 SCALE:
 SHEET: 1/4
 DRAW: AK



DESCRIPTION: USB 3.1 TYPE C RECEPTACLE - HORIZONTAL THT/SMT
 WERI PART NO: 632 723 x00 011

SIZE
A4

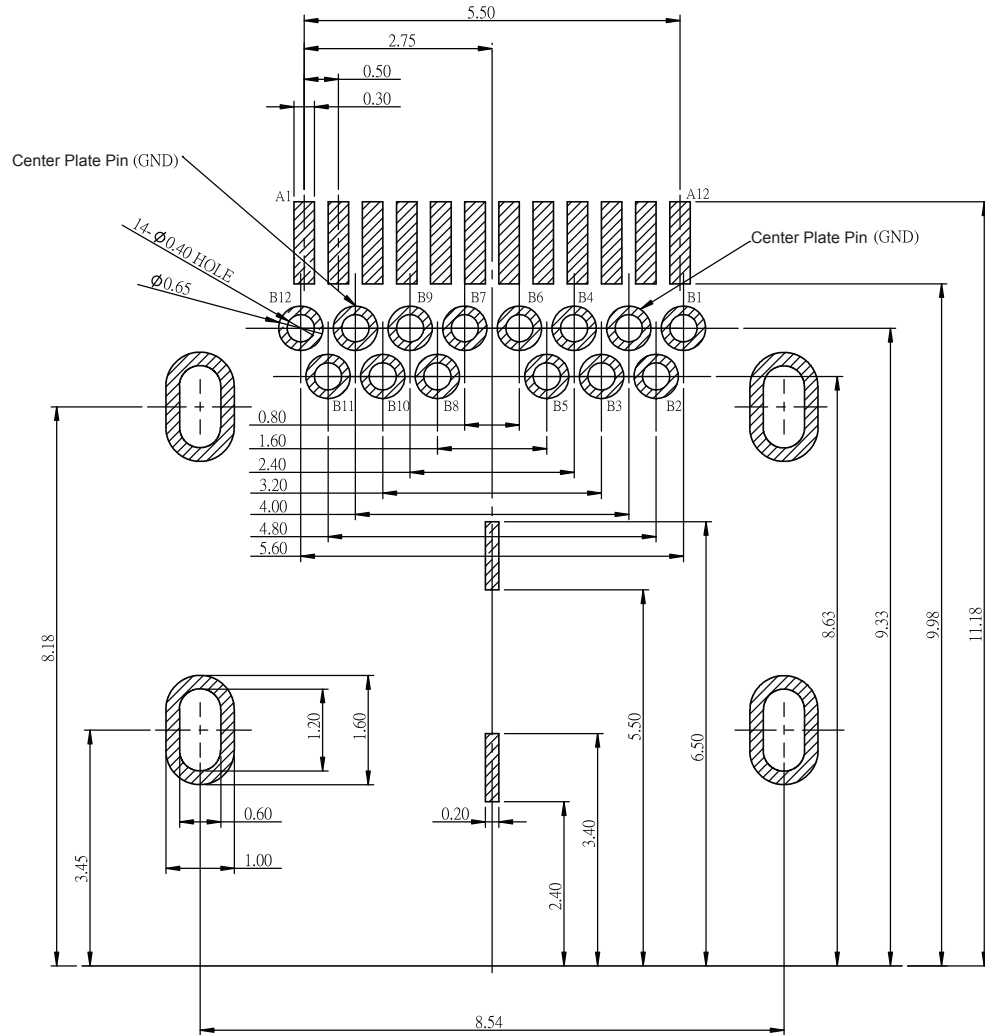

PCB LAYOUT - COMPONENT VIEW

Pin Number	Signal Name	Pin Number	Signal Name
A1	GND	B12	GND
A2	SSTXp1	B11	SSRXp1
A3	SSTXn1	B10	SSRXn1
A4	VBUS	B9	VBUS
A5	CC1	B8	SBU2
A6	Dp1	B7	Dn2
A7	Dn1	B6	Dp2
A8	SBU1	B5	CC2
A9	VBUS	B4	VBUS
A10	SSRXn2	B3	SSTXn2
A11	SSRXp2	B2	SSTXp2
A12	GND	B1	GND

X	PCB THICKNESS
1	1.00 MM
3	1.60 MM

RoHS Compliant			
G			
F			
E			
D			
C			
B			
A			
REV	DATE	FILE	BY

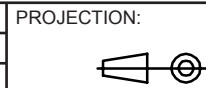

APPROVAL: NPr

GENERAL TOLERANCE
 .X = +/- 0.2
 .XX = +/- 0.15



UNIT: MM
 SCALE:
 SHEET: 2/4
 DRAW: AK

DESCRIPTION: USB 3.1 TYPE C RECEPTACLE - HORIZONTAL THT/SMT
 WERI PART NO: 632 723 x00 011

SIZE
A4

A

B

C

D

1

2

3

4

5

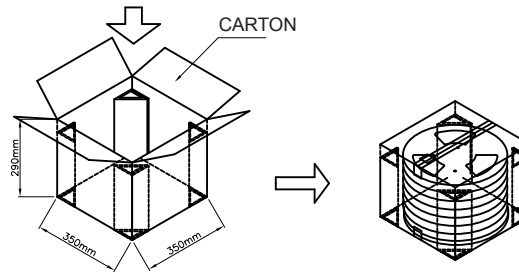
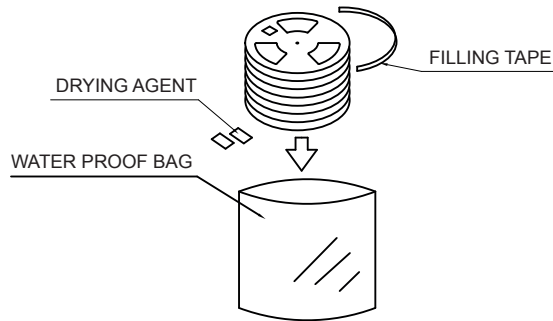
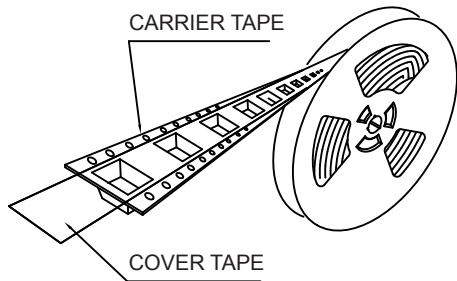
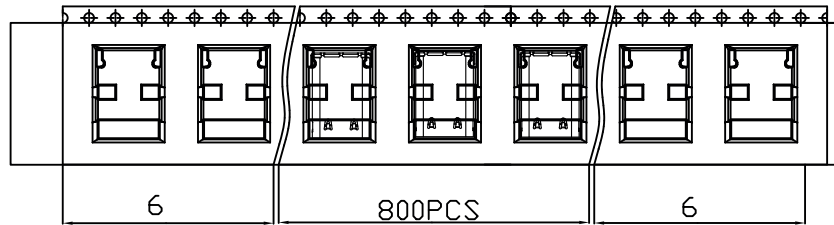
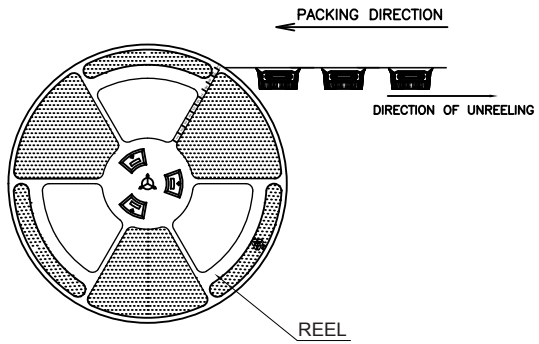

800 pcs/reel
 9 reels/carton
 7200 pcs/carton

RoHS Compliant			
G			
F			
E			
D			
C			
B			
A			
REV	DATE	FILE	BY

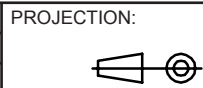

APPROVAL: NPr

GENERAL TOLERANCE

.X = +/- 0.2

.XX = +/- 0.15

UNIT: MM

SCALE:

SHEET: 3/4

DRAW: AK



DESCRIPTION: USB 3.1 TYPE C RECEPTACLE - HORIZONTAL THT/SMT

WERI PART NO: 632 723 x00 011

SIZE

A4

1

2

3

4

5

Cautions and Warnings:

This electronic component is designed and developed with the intention for use in general electronics equipments.



Before incorporating the components into any equipments in the field such as aerospace, aviation, nuclear control, submarine, transportation, (automotive control, train control, ship control), transportation signal, disaster prevention, medical, public information network etc. where higher safety and reliability are especially required or if there is possibility of direct damage or injury to human body, Würth Elektronik must be asked for a written approval.

In addition, even electronic component in general electronic equipments, when used in electrical circuits that require high safety, reliability functions or performance, the sufficient reliability evaluation-check for the safety must be performed before by the user before usage.

A

B

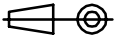
C

RoHS Compliant				PROJECTION: 	GENERAL TOLERANCE .X = +/- 0.2 .XX = +/- 0.15		DESCRIPTION: DISCLAIMER	SIZE A4
G								
F								
E								
D								
C				APPROVAL: JC	UNIT: MM	WERI PART NO: DISCLAIMER	SIZE A4	
B				SCALE:				
A	10-SEP-14	PDF	QL	SHEET: 4/4				
REV	DATE	FILE	BY	DRAW: QL				

D