



mikromedia+

for PIC32MX7®

Amazingly compact, all-on-single-pcb development board carrying 4.3" TFT Touch Screen and lots of multimedia peripherals, all driven by powerful **PIC32MX795F512L** microcontroller.



TO OUR VALUED CUSTOMERS

I want to express my thanks to you for being interested in our products and for having confidence in MikroElektronika.

The primary aim of our company is to design and produce high quality electronic products and to constantly improve the performance thereof in order to better suit your needs.

A handwritten signature in white ink, appearing to read 'N. Matic', is positioned on the right side of the page.

Nebojsa Matic
General Manager

Table of Contents

Introduction to mikromedia+ for PIC32MX7®	4	6. Port Expander	22
System Specification	4	7. MicroSD Card Slot	24
Package Contains	5	8. Touch Screen	26
1. Power Supply	6	9. Audio Module	28
2. PIC32MX795F512L Microcontroller	8	10. USB DEVICE Connection	30
Key Microcontroller Features	8	11. USB HOST Connection	32
3. Programming the Microcontroller	9	12. Accelerometer	34
Programming with mikroBootloader	10	13. Flash Memory	36
step 1 - Connecting mikromedia	10	14. RF Transceiver	38
step 2 - Browsing for .HEX file	11	15. Ethernet Transceiver	40
step 3 - Selecting .HEX file	11	16. Buzzer	42
step 4 - Uploading .HEX file	12	17. Other Modules	44
step 5 - Finish upload	13	18. Pads	46
Programming with mikroProg™ Programmer	14	19. mikromedia+ for PIC32MX7® SHIELD	48
mikroProg suite™ for PIC® Software	16	20. Click boards are plug and play!	50
Software Installation Wizard	17	21. Dimensions	52
4. Reset Button	18	22. What's next	53
5. Crystal Oscillators and 2.048V Reference	20		

Introduction to mikromedia+ for PIC32MX7®

The **mikromedia+ for PIC32MX7®** is a compact development system which allows development of devices with multimedia contents. The central part of the system is a 32-bit 100-pin **PIC32MX795F512L** microcontroller. The mikromedia+ for PIC32MX7® feature lots of on board modules such as stereo MP3 codec, **4.3" TFT 480x272** touch screen display, port expander, accelerometer, microSD card slot, buzzer, IR receiver, RGB LED diode, PIN photodiode, temperature sensor, 2.4GHz RF transceiver, Ethernet transceiver, 8 Mbit flash memory, Li-Polimer battery charger etc. The board also contains MINI-B USB connector, power screw terminals, 2x5 mikroProg™ connector, two 1x26 connection pads, ON/OFF switch and other. It comes pre-programmed with USB HID bootloader, but can also be programmed with **mikroProg™ for PIC®, dsPIC® and PIC32®** external programmer. mikromedia is compact and slim, and perfectly fits in the palm of your hand, which makes it a convenient platform for mobile and other multimedia devices. We have also prepared a **mikromedia+ SHIELD for PIC32MX7®** extension board which enables you to easily expand the functionality of your board.

System Specification



power supply

Via USB cable (5V DC) or via screw terminals (5 - 12V DC)



power consumption

65mA with erased MCU
(when on-board modules are inactive)

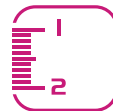

board dimensions

119.54 x 78mm (4.71 x 3.07inch)



weight

~115g (0.253lbs)

Package Contains



- 01 Damage resistant protective box



- 02 mikromedia+ for PIC32MX7[®] development system

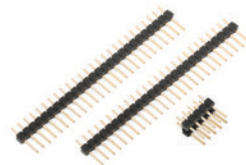

- 03 Two 1x26 male headers and one 2x5 header



- 04 mikromedia+ for PIC32MX7[®] user's guide



- 05 mikromedia+ for PIC32MX7[®] schematic



- 06 USB cable and microSD card

1. Power Supply

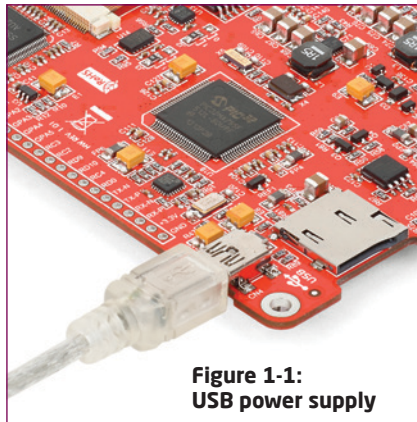

Figure 1-1:
USB power supply

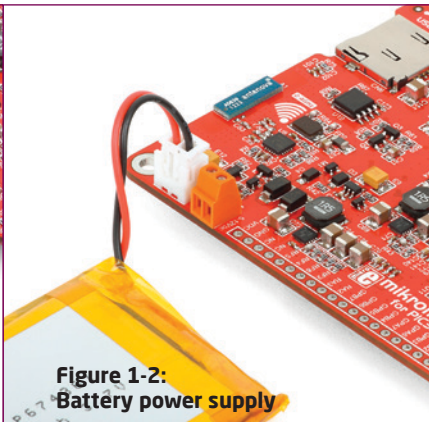

Figure 1-2:
Battery power supply

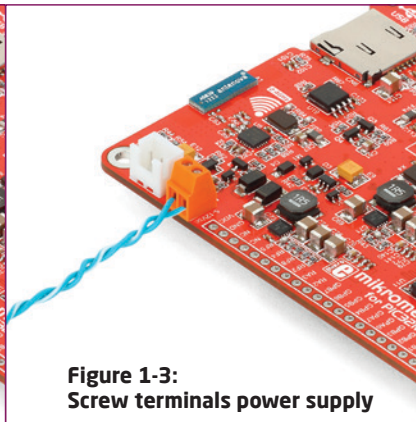

Figure 1-3:
Screw terminals power supply

The mikromedia+ for PIC32MX7[®] board can be powered in three different ways: via USB connector using MINI-B USB cable provided with the board (**CN4**), via battery connector using Li-Polymer battery (**CN5**) or via screw terminals using laboratory power supply (**CN3**). After you plug in the appropriate power supply turn the power switch ON (**SW1**). The USB connection can provide up to 500mA of current which is more than enough for the operation of all on-board modules and the microcontroller as well. If you decide to use external power supply via screw terminals, voltage levels must be within **5-12V DC** range. Power **LED ON (GREEN)** indicates the presence of power supply. On-board battery charger circuit **MCP73832** enables you to charge the battery over USB connection or via screw terminals. **LED diode (RED)** indicates when battery is charging. Charging current is ~250mA and charging voltage is 4.2V DC.

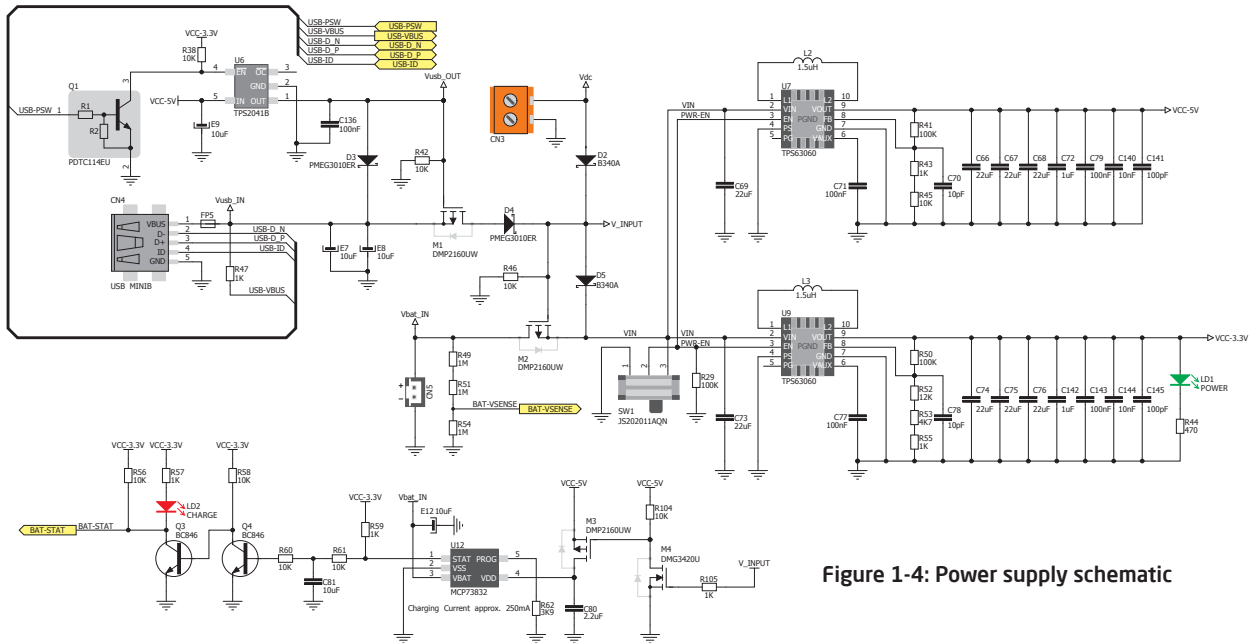

Figure 1-4: Power supply schematic

2. PIC32MX795F512L microcontroller

The mikromedia+ for PIC32MX7® development board comes with the 100-pin **PIC32MX795F512L** microcontroller. This high-performance **32-bit** microcontroller has integrated modules, such as 512K of flash and 128K of RAM easily handling demanding applications.

Key microcontroller features

- Up to **125 DMIPS** Operation (80MHz);
- 512K bytes of Flash memory;
- 128K bytes of RAM memory;
- up to 85 I/O pins;
- 16-bit timers;
- 8MHz internal oscillator, 32kHz RTCC, PLL;
- 6xUART, 4xSPI, 5xI²C, 2xCAN, ADC etc., and
- Ethernet, USB etc.

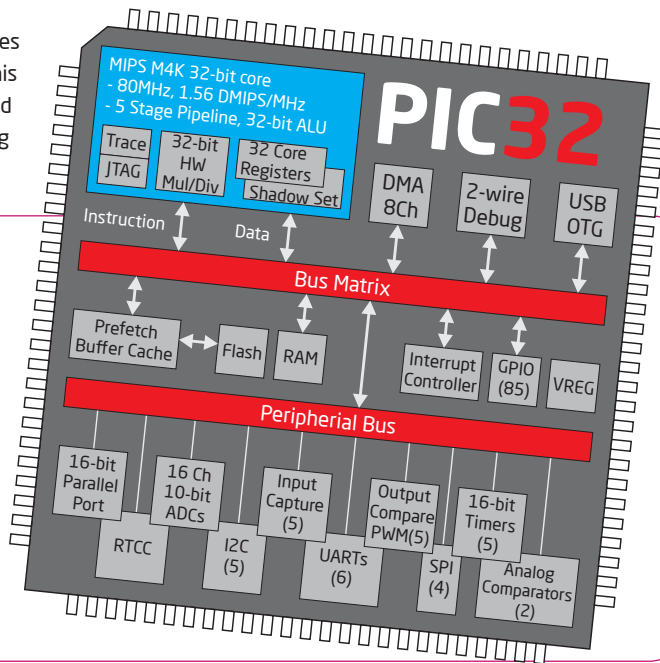

3. Programming the microcontroller

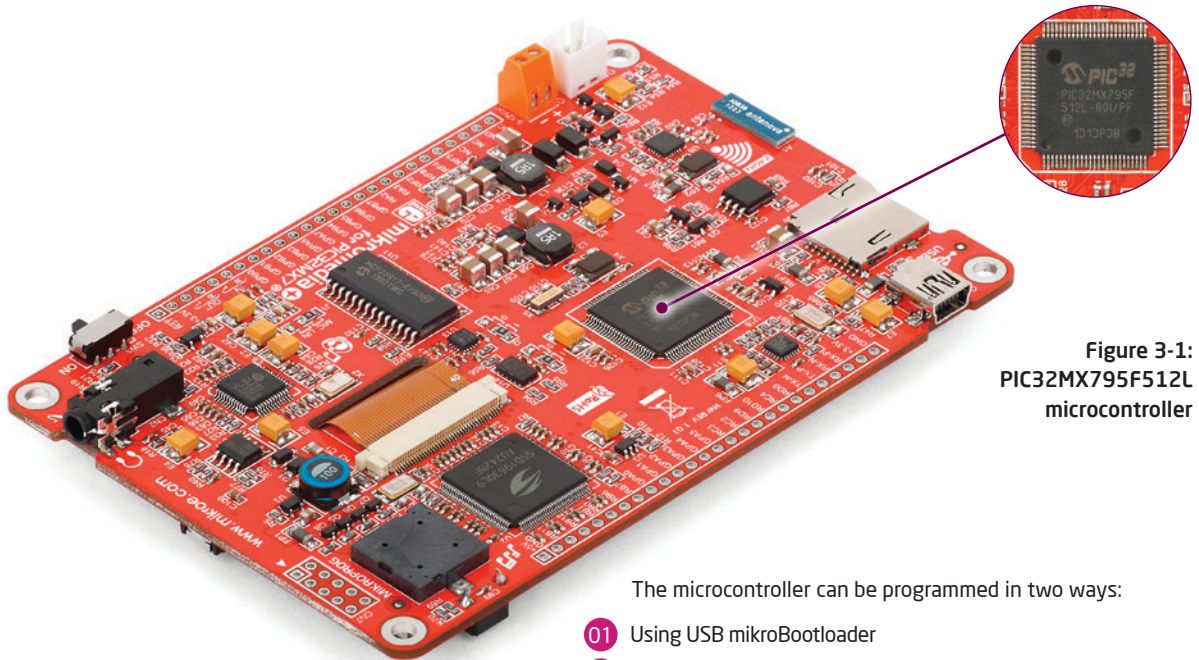

Figure 3-1:
PIC32MX795F512L
microcontroller

The microcontroller can be programmed in two ways:

- 01 Using USB mikroBootloader
- 02 Using external mikroProg™ for PIC®, dsPIC®, PIC32® programmer

Programming with mikroBootloader

Microcontroller is pre-programmed with USB HID Bootloader, which can be used to upload new device firmware. To transfer firmware .HEX file from a PC to MCU you need to use mikroBootloader USB HID application, which can be downloaded from:



http://www.mikroe.com/downloads/get/2031/mikromedia_plus_pic32mx7_bootloader.zip

Upon download, unzip it to desired location and start the mikroBootloader application:

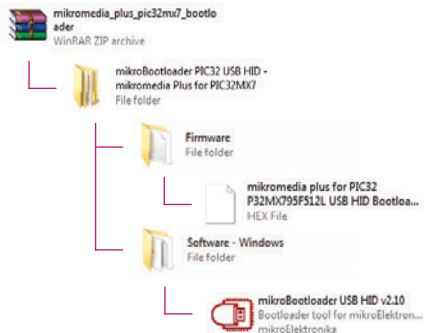

step 1 - Connecting mikromedia



Figure 3-2: USB HID mikroBootloader window

- 01 In order to start, connect the USB cable or (if already connected) press the **Reset** button on your mikromedia+ board. Click the **Connect** button within 5s to enter the bootloader mode, otherwise the existing microcontroller program will be executed.

step 2 - Browsing for .HEX file



Figure 3-3: Browse for HEX

- 01 Click the **Browse for HEX** button and from a pop-up window (**Figure 3.4**) choose the .HEX file that will be uploaded to MCU memory.

step 3 - Selecting .HEX file

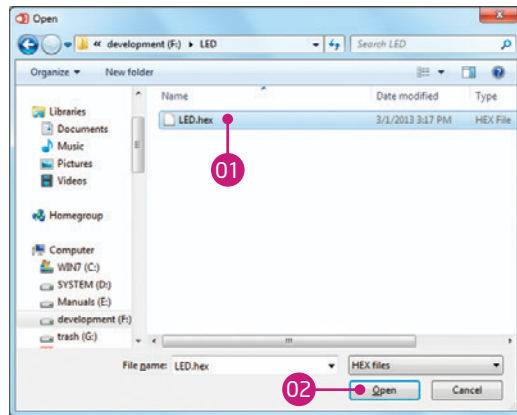

Figure 3-4: Selecting HEX

- 01 Select .HEX file from the Open dialog window.
- 02 Click the **Open** button.

step 4 - Uploading .HEX file



Figure 3-5: Begin uploading

- 01 In order to upload .HEX file click the **Begin uploading** button.



Figure 3-6: Progress bar

- 01 .HEX file uploading can be monitored via progress bar.

step 5 - Finish Upload

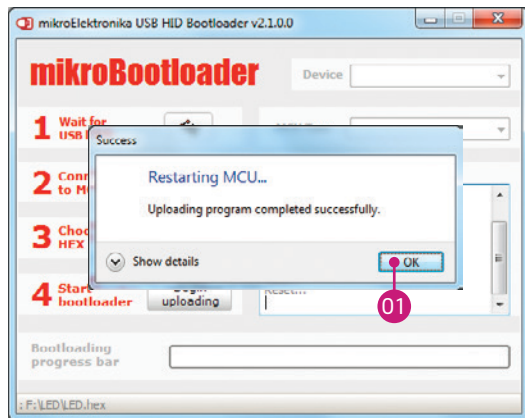

Figure 3-7: Restarting MCU

- 01** Click the **OK** button after uploading is finished. The board will be automatically reset and after 5 seconds your new program will be executed.



Figure 3-8: mikroBootloader ready to use

Programming with mikroProg™ Programmer



Figure 3-9:
mikroProg™
connector

The microcontroller can be programmed with external **mikroProg™ for PIC®, dsPIC® and PIC32® programmer** and **mikroProg Suite™ for PIC® software**. The external programmer is connected to the development system via 2X5 mikroProg™ connector, **Figure 3-9**. **mikroProg™** is a fast USB 2.0 programmer with hardware Debugger support. It supports IC10®, PIC12®, PIC16®, PIC18®, dsPIC30/33®, PIC24® and PIC32® devices from Microchip®. Outstanding performance, easy operation and elegant design are its key features.

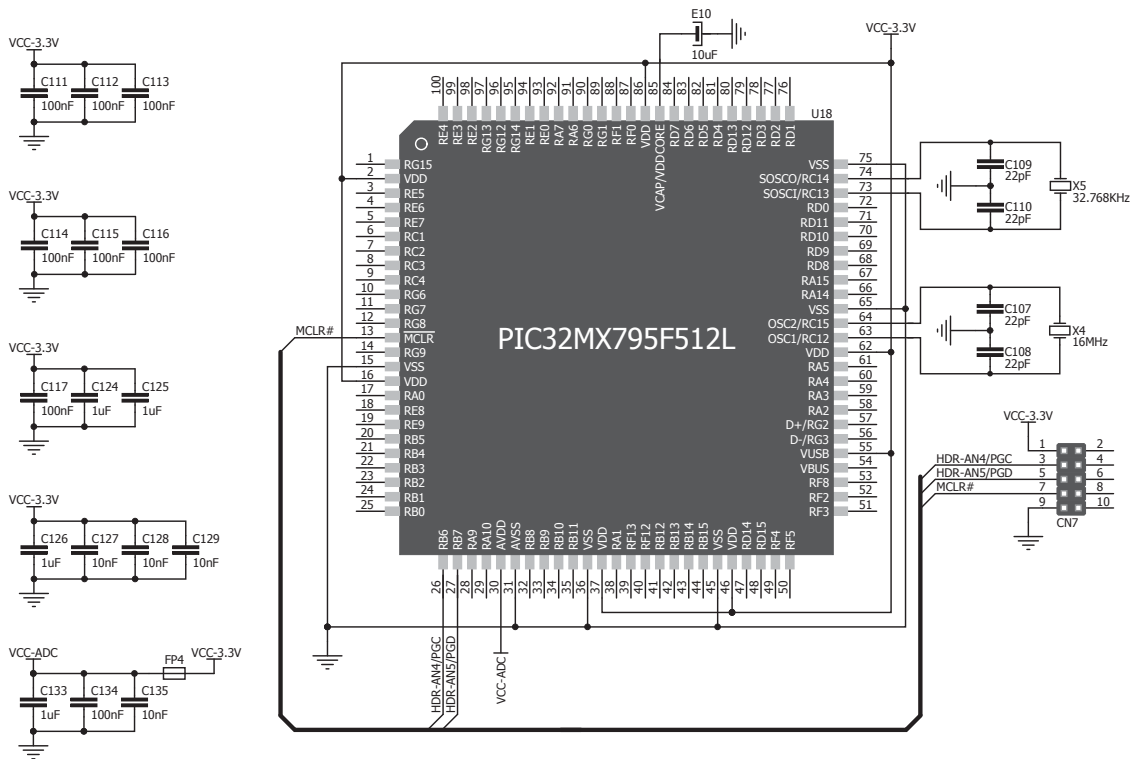

Figure 3-10: mikroProg™ connection schematic

mikroProg Suite™ for PIC® Software



The **mikroProg™** programmer requires special programming software called **mikroProg Suite™ for PIC®**. It can be used for programming all Microchip® microcontroller families, including PIC10®, PIC12®, PIC16®, PIC18®, dsPIC30/33®, PIC24® and PIC32®. Software has intuitive interface and SingleClick™ programming technology. Download the latest version of **mikroProg Suite™** and your programmer is ready to program new devices. **mikroProg Suite™** is updated regularly, at least four times a year, so your programmer will be more and more powerful with each new release.

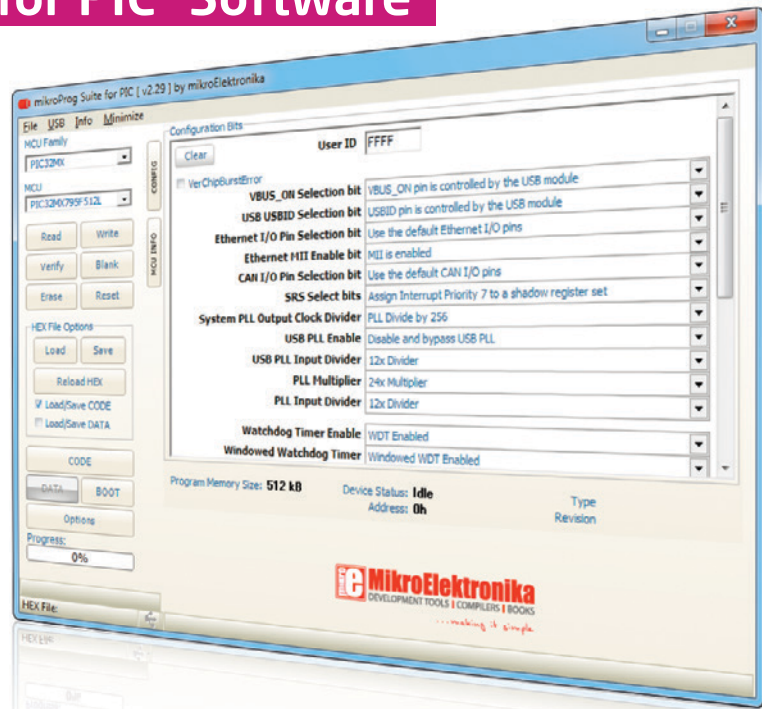
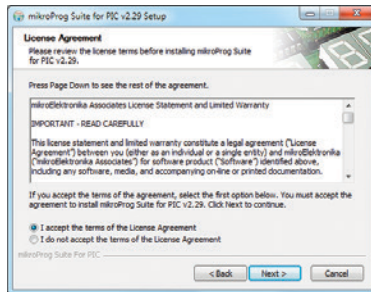

Figure 3-11: Main window of mikroProg Suite™ for PIC® programming software

Software Installation Wizard



01 Start Installation



02 Accept EULA and continue

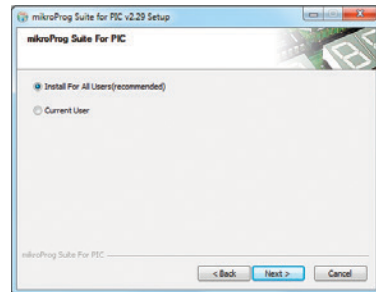

03 Install for all users

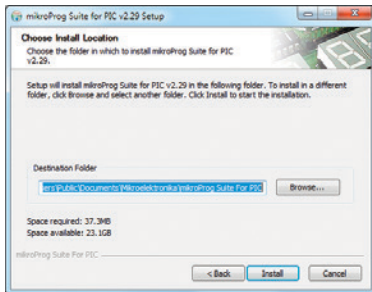

04 Choose destination folder

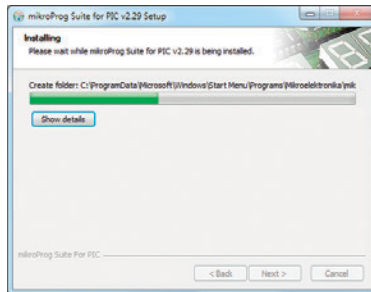

05 Installation in progress



06 Finish installation

4. Reset Button

The board is equipped with reset button, which is located on the front side of the board. One press on the reset button will generate a low voltage level on the microcontroller reset pin (input). Reset button can also be externally provided through the **pin 27** on the side headers.

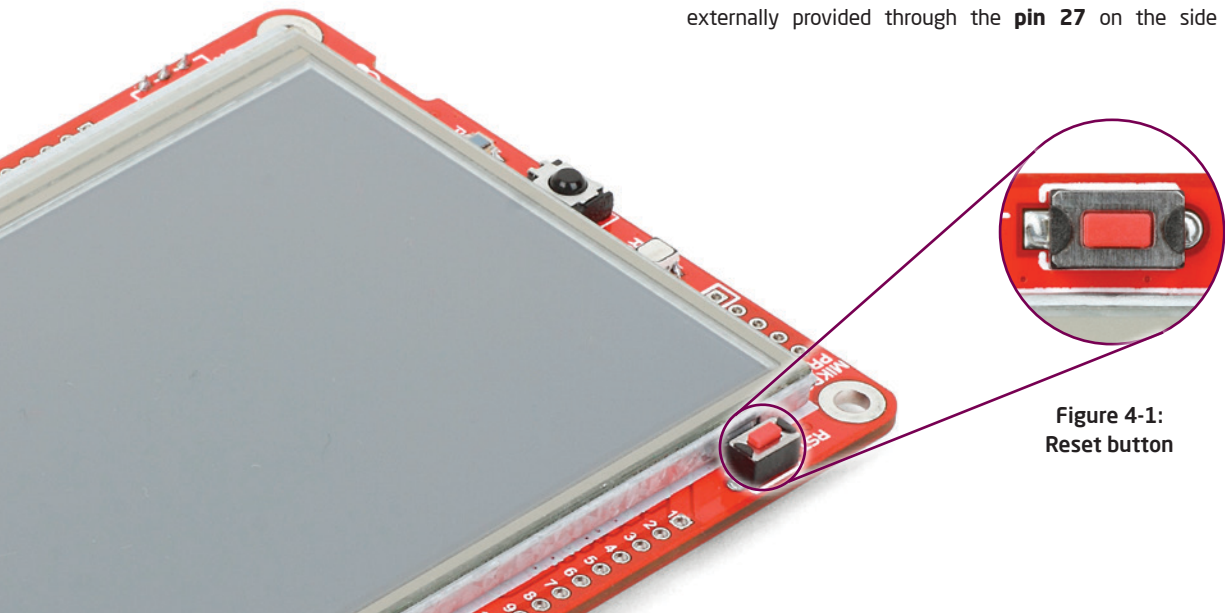

Figure 4-1:
Reset button

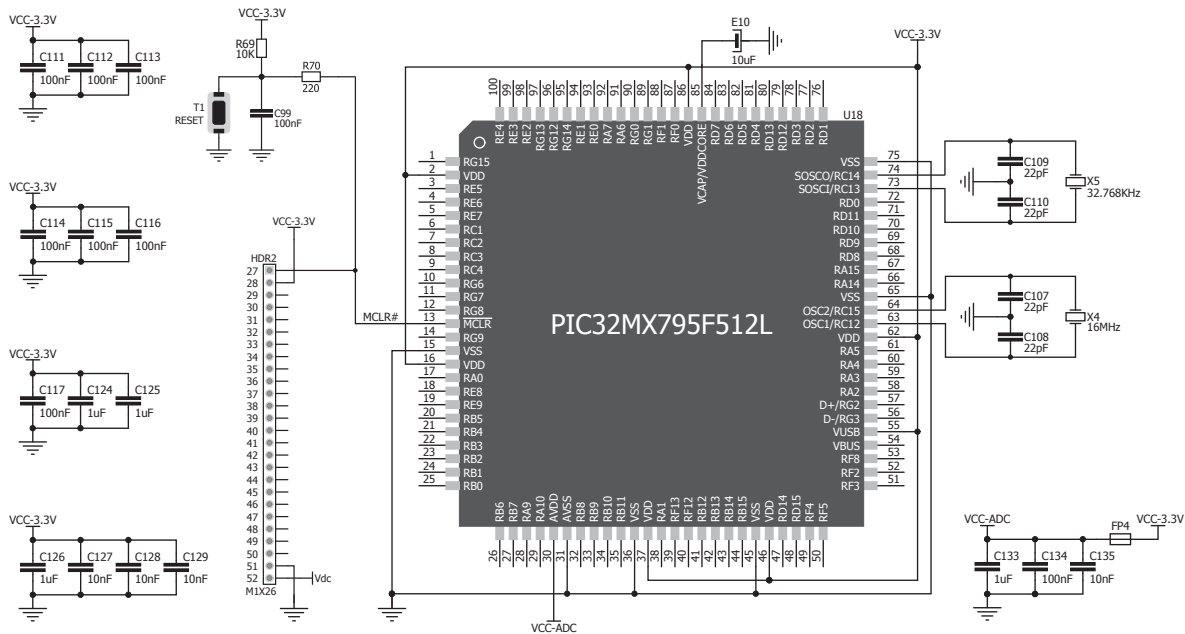

Figure 4-2: Reset button connection schematic

5. Crystal Oscillators and 2.048V Reference

The board is equipped with **01 16MHz crystal oscillator (X4)** circuit that provides external clock waveform to the microcontroller OSC1 and OSC2 pins. This base frequency is suitable for further clock multipliers and ideal for generation of necessary USB clock, which ensures proper operation of bootloader and your custom USB-based applications. The board also contains **02 32.768kHz crystal oscillator (X5)** which provides external clock for internal RTCC module. Microcontroller ADC requires an accurate source of reference voltage signal. That is why we provide the external **03 voltage reference** to the microcontroller VREF pin which is **2.048V**.

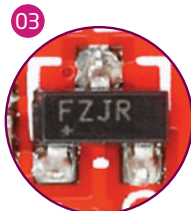
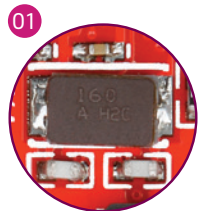
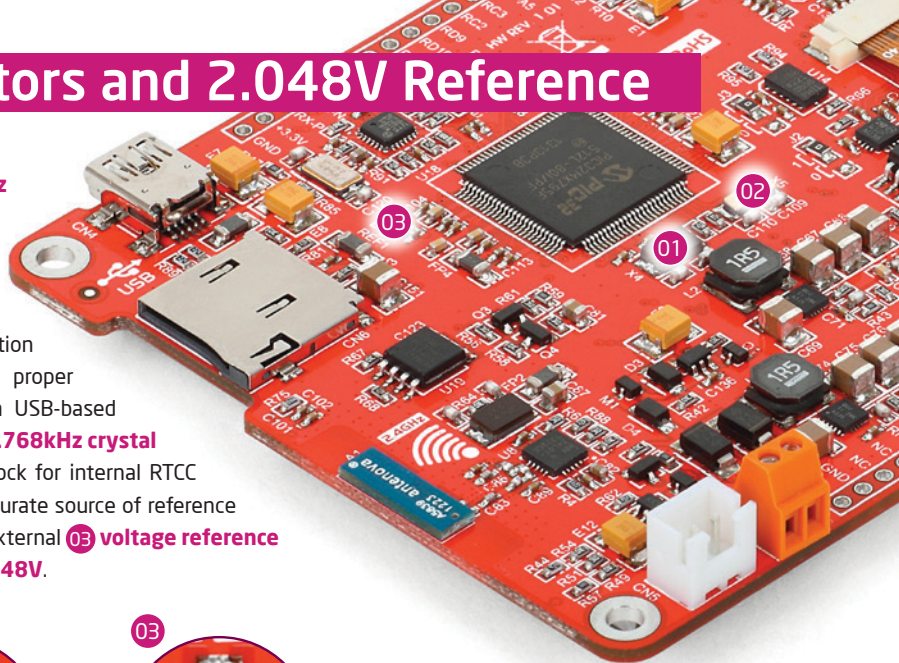

Figure 5-1: Crystal oscillator and 2.048V reference

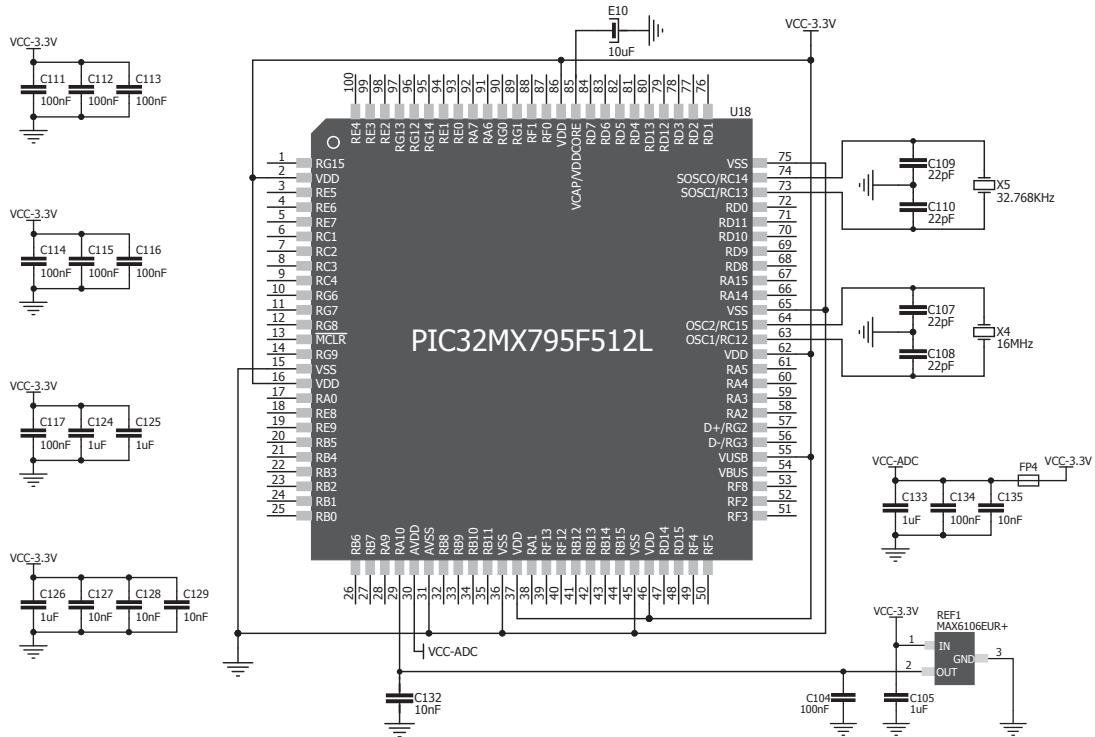

Figure 5-2: Crystal oscillators and voltage reference connection schematic

6. Port Expander

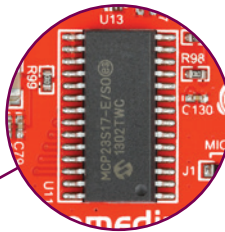
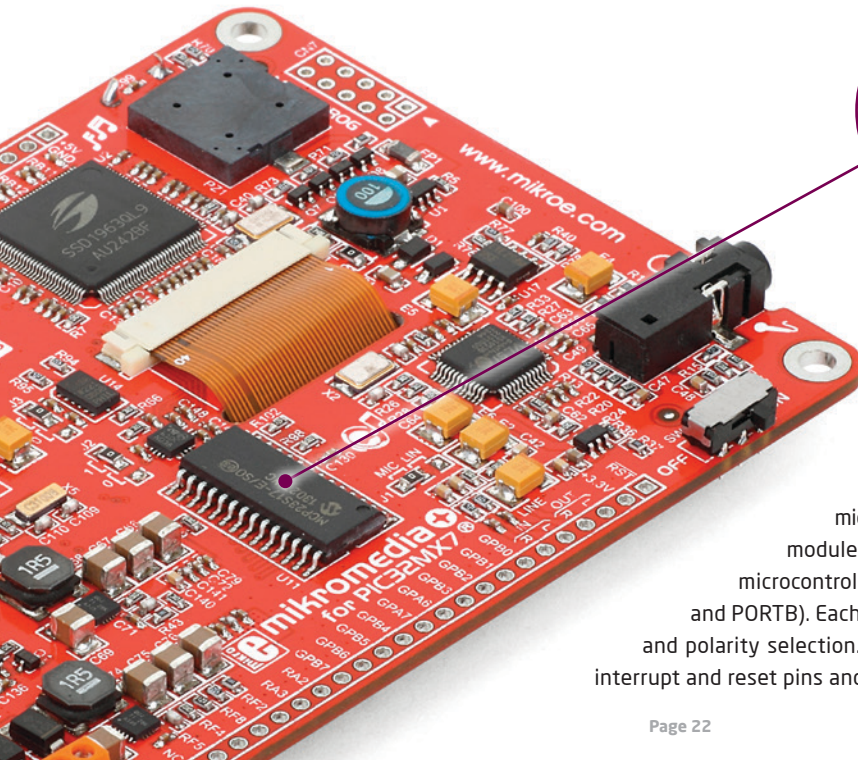
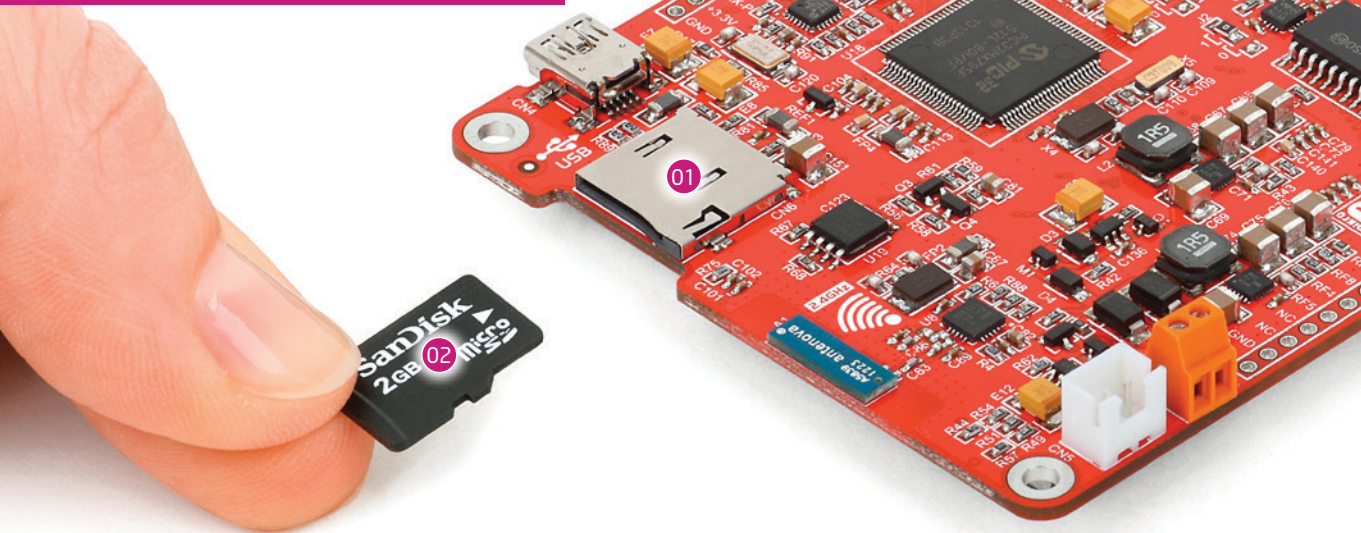

Figure 6-1:
Port Expander

mikromedia+ for PIC32MX7[®] features a 16-bit I/O port expander module **MCP23S17** which communicates with PIC32MX795F512L microcontroller via SPI serial interface. This module enables you to expand the number of microcontroller I/O pins with two 8-bit I/O ports (PORTA and PORTB). Each of them consists of registers for input, output and polarity selection. In addition, the **MCP23S17** module contains interrupt and reset pins and has 25mA sink/source capability per I/O pin.

7. microSD Card Slot



The board contains **01** microSD card slot for using **02** microSD cards in your projects. It enables you to store large amounts of data externally, thus saving microcontroller memory. microSD cards use Serial Peripheral Interface (**SPI**) for communication with the microcontroller. Ferrite and capacitor are provided to compensate the voltage and current glitch that can occur when pushing-in and pushing-out microSD card into the socket. Proper insertion of the microSD card is shown in **Figure 7-1**.

Figure 7-1:
microSD Card Slot

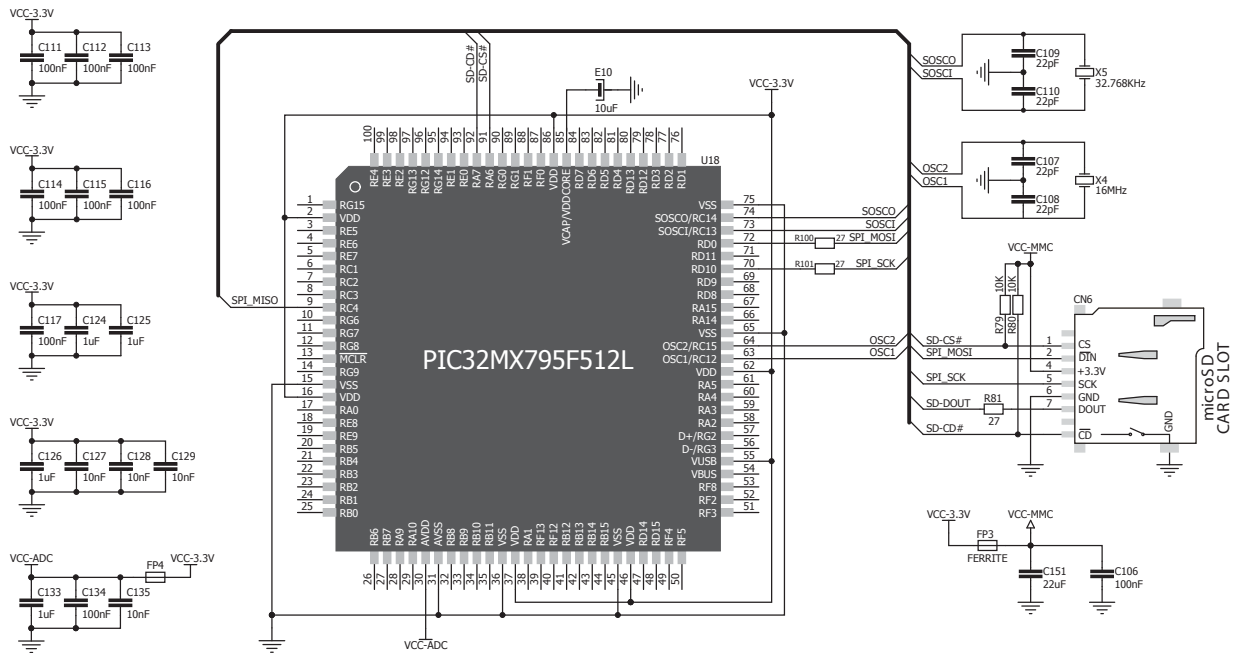
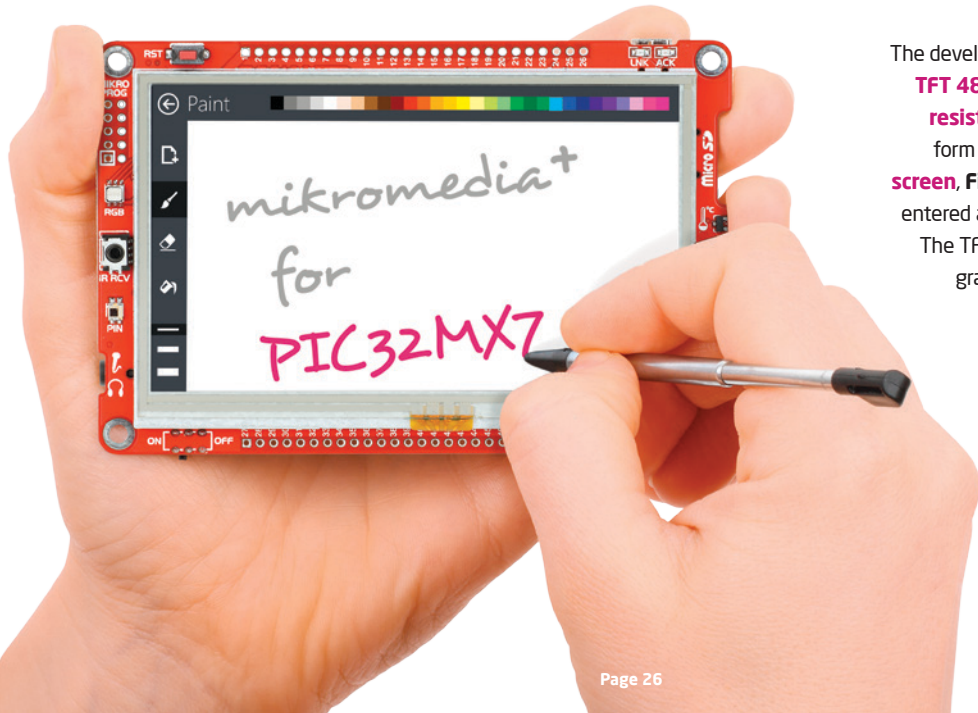

Figure 7-2: microSD Card Slot module connection schematic

8. Touch Screen



The development system features a **4.3" TFT 480x272 display** covered with a **resistive** touch panel. Together they form a functional unit called a **touch screen**, **Figure 8-1**. It enables data to be entered and displayed at the same time. The TFT display is capable of showing graphics in **256K** different **colors**.

Figure 8-1: Touch Screen

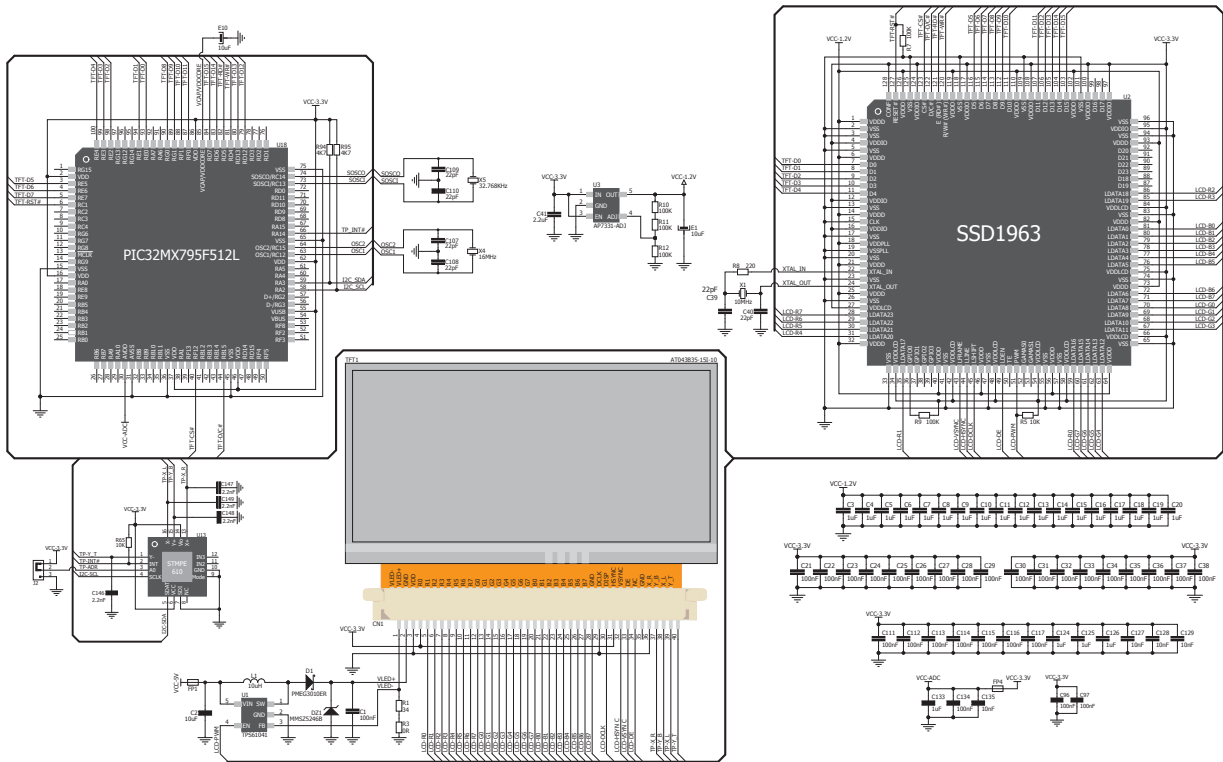
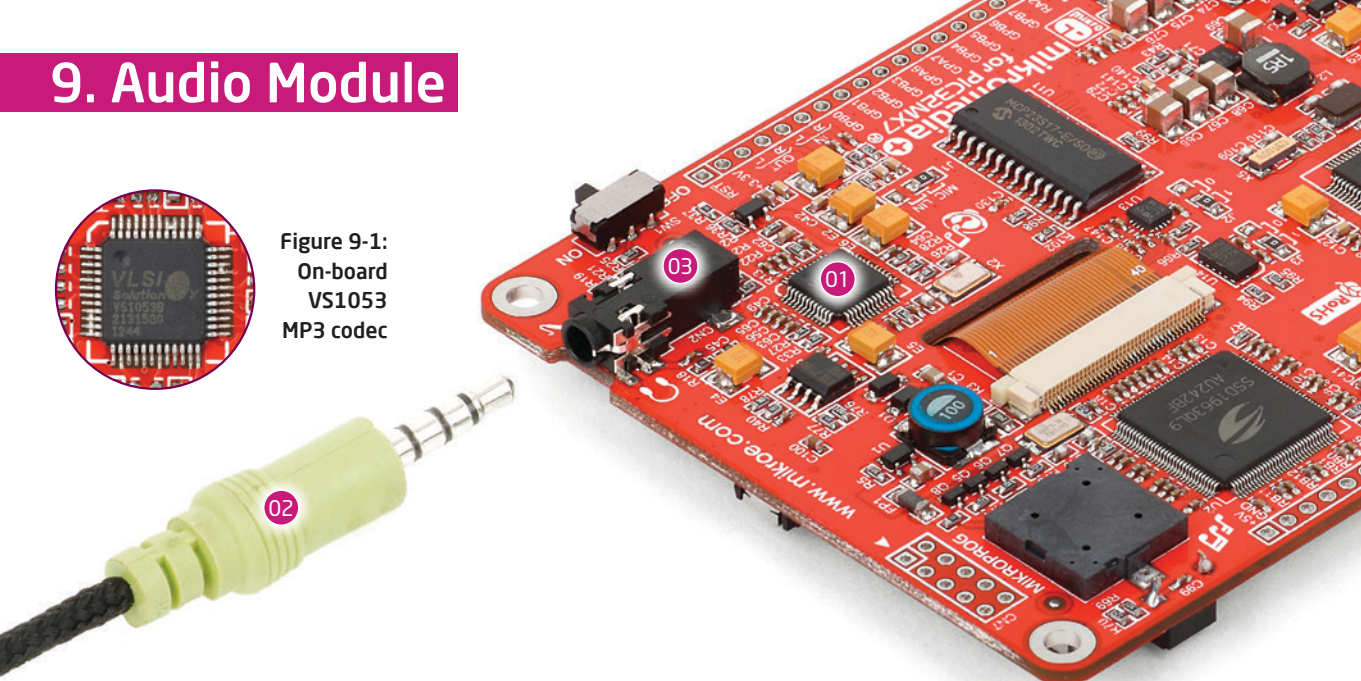

Figure 8-2: Touch Screen connection schematic

9. Audio Module



Figure 9-1:
On-board
VS1053
MP3 codec



mikromedia+ for PIC32MX7® features stereo audio codec **01 VS1053**. This module enables audio reproduction and sound recording by using **02 stereo headphones with microphone** connected to the system via a **03 3.5mm** connector CN2. All functions of this module are controlled by the microcontroller over Serial Peripheral Interface (**SPI**). IN and OUT channels are also provided on side headers.

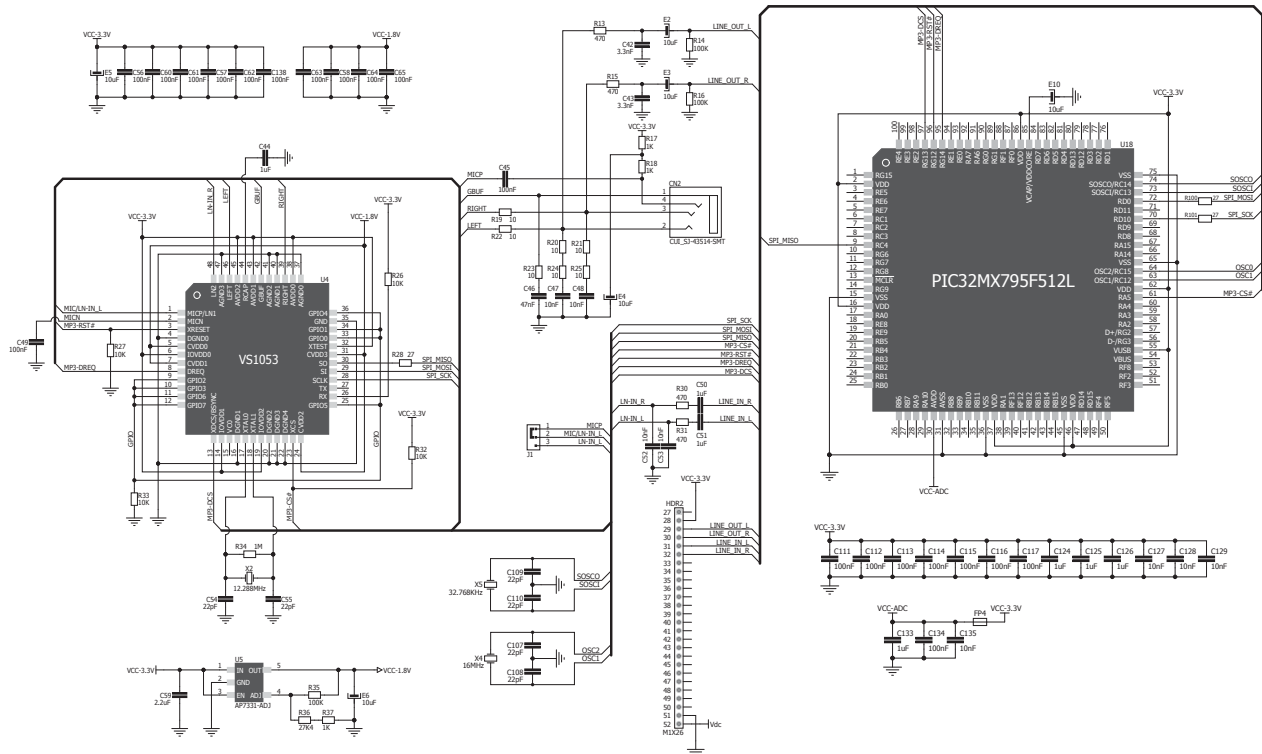

Figure 9-2: Audio module connection schematic

11. USB HOST connection

Note: When the device is working in USB HOST mode, it must not be mounted to other USB HOST.

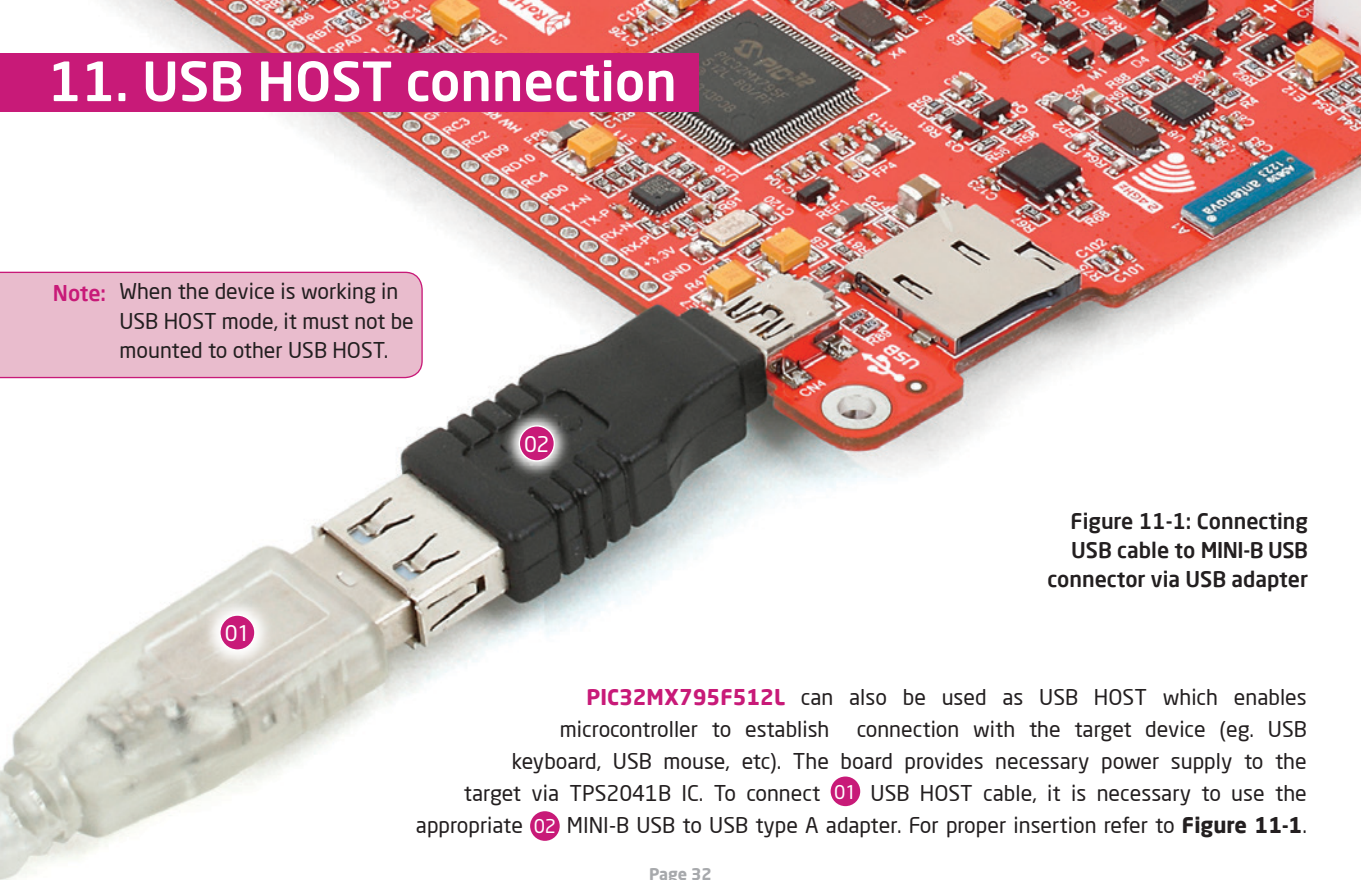

Figure 11-1: Connecting USB cable to MINI-B USB connector via USB adapter

PIC32MX795F512L can also be used as USB HOST which enables microcontroller to establish connection with the target device (eg. USB keyboard, USB mouse, etc). The board provides necessary power supply to the target via TPS2041B IC. To connect **01** USB HOST cable, it is necessary to use the appropriate **02** MINI-B USB to USB type A adapter. For proper insertion refer to **Figure 11-1**.

12. Accelerometer



Figure 12-1:
Accelerometer
module

On board **ADXL345** accelerometer is used to measure acceleration in three axis: x, y and z. Most common use is to determine the screen orientation, but there are many other fields of usage. Communication between the accelerometer and the microcontroller is performed through **I²C** interface. There is an option to select the alternate accel address with jumper **J3**.

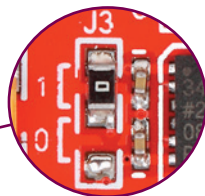
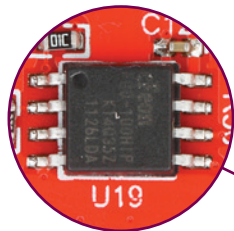

Figure 12-2:
Jumper J3

13. Flash Memory



Since multimedia applications are getting increasingly demanding, it is necessary to provide additional memory space for storing more data. The flash memory module enables the microcontroller to use additional **8Mbit** flash memory. It is connected to the microcontroller via the Serial Peripheral Interface (**SPI**).

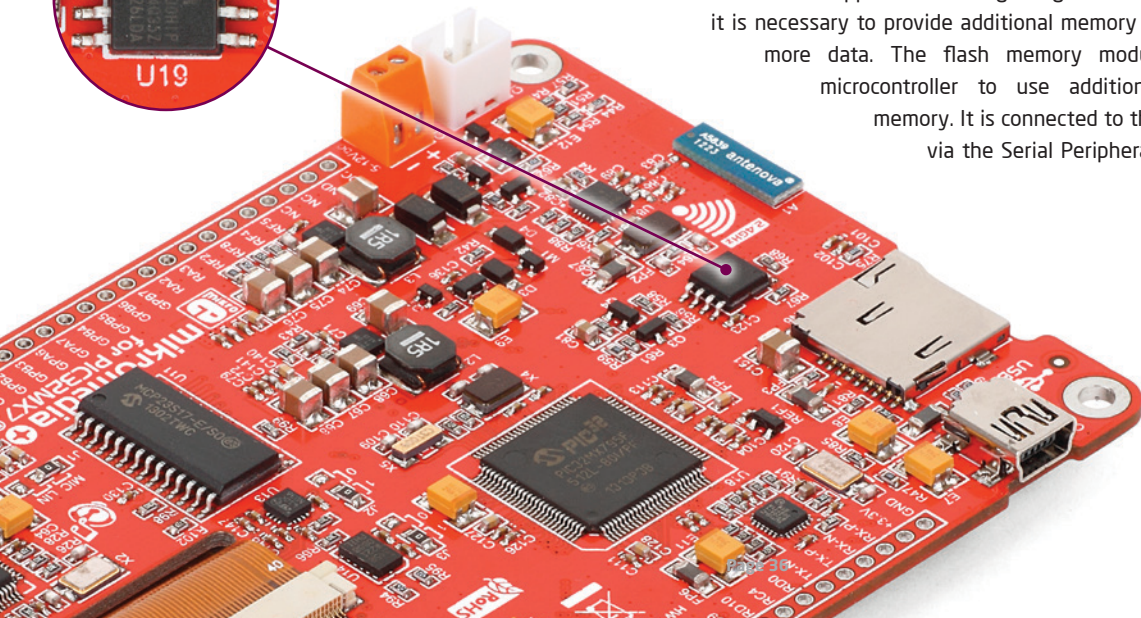

Figure 13-1:
Flash memory
module

14. RF Transceiver

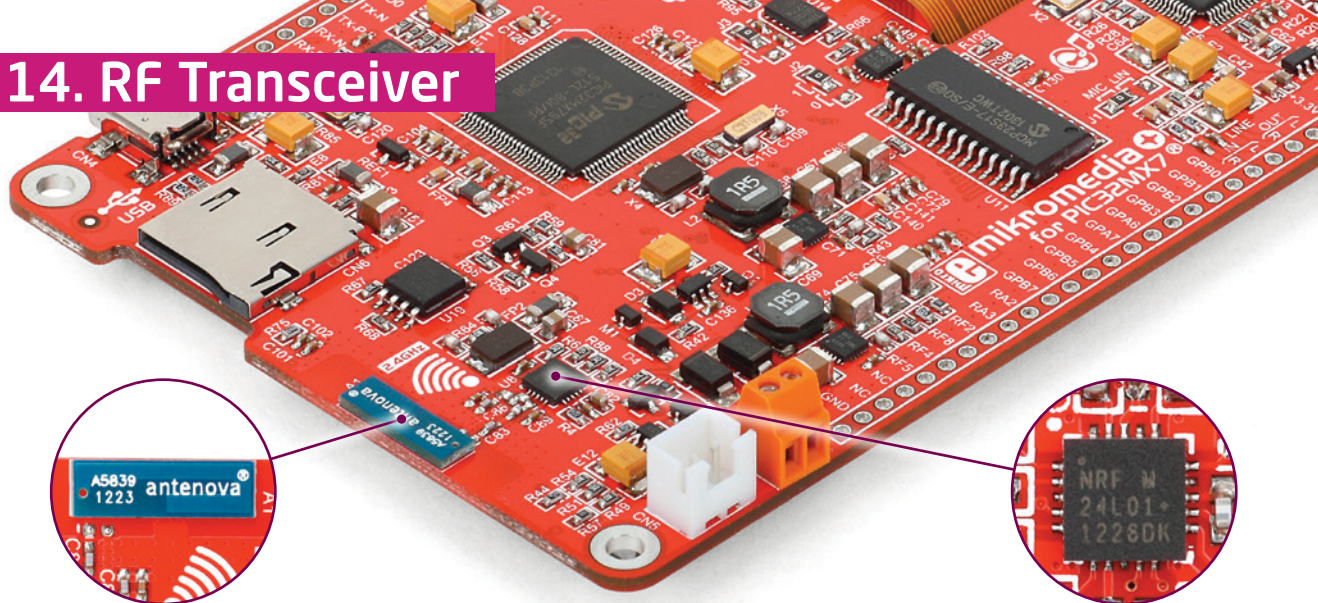

Figure 14-1:
RF transceiver antenna



Figure 14-2:
RF transceiver module

mikromedia+ for PIC32MX7® board features **RF transceiver** chip with **2.4GHz chip antenna**. It is suitable for wireless operation in the world wide ISM frequency band at 2.400 - 2.4835GHz with air data rate up to 2Mbps. RF transceiver module is connected to the microcontroller via the Serial Peripheral Interface (**SPI**). This RF transceiver module is widely used for wireless PC peripherals, remote controllers, VoIP headsets, game controllers, sensors, home and commercial automation, active RFID, toys and many more.

15. Ethernet Transceiver

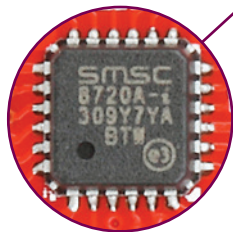
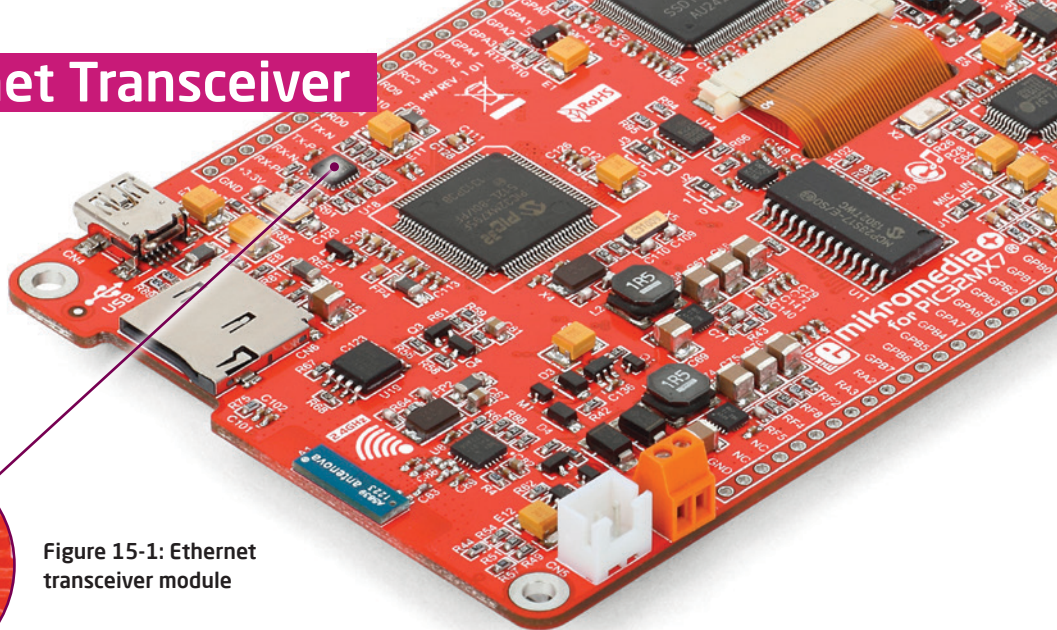

Figure 15-1: Ethernet transceiver module



The development system features an Ethernet transceiver module ideal for local area networking (LAN). Communication over Ethernet is based on data packets called frames. Each frame contains source and destination addresses and error-checking data so that damaged data can be detected and re-transmitted. If you want to establish connection with computer, router or other devices you need to use standard **RJ-45** connector which is provided on **mikromedia+ SHIELD for PIC32MX7**[®]. Communication lines are also provided over side headers.

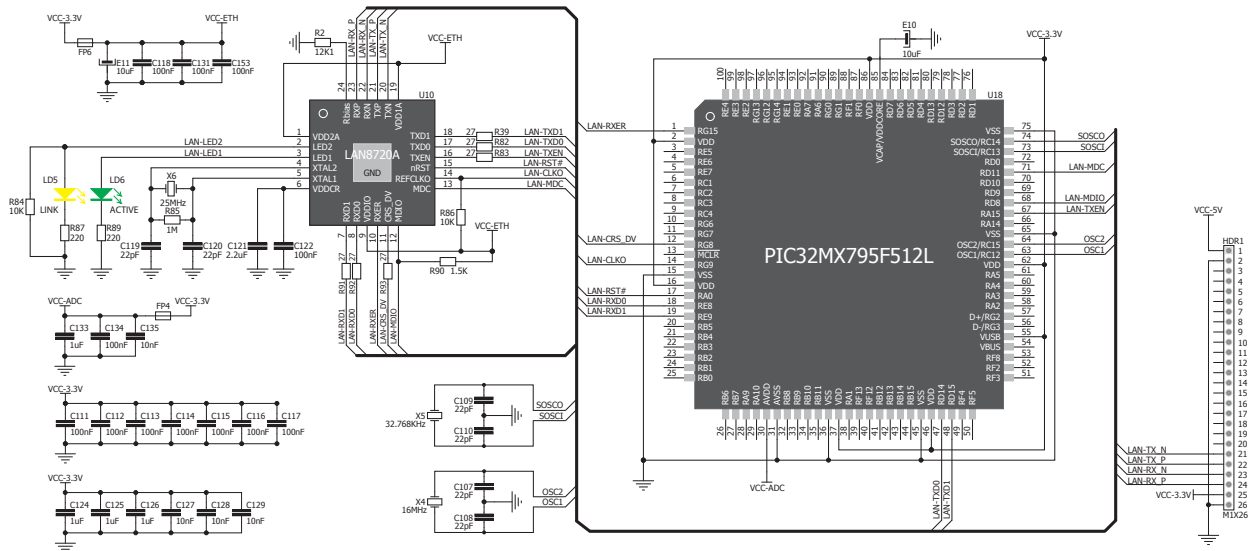

Figure 15-2: Ethernet transceiver module schematic

16. Buzzer

The board is also equipped with piezo buzzer. It is an electric component which can be used to create sound when is provided with electrical signal. This is usually a PWM signal coming from a microcontroller pin. Frequency of the signal determines the pitch of the sound and duty cycle of the signal can be used to increase or decrease the volume.

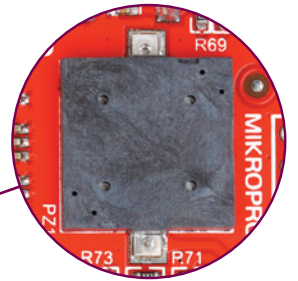
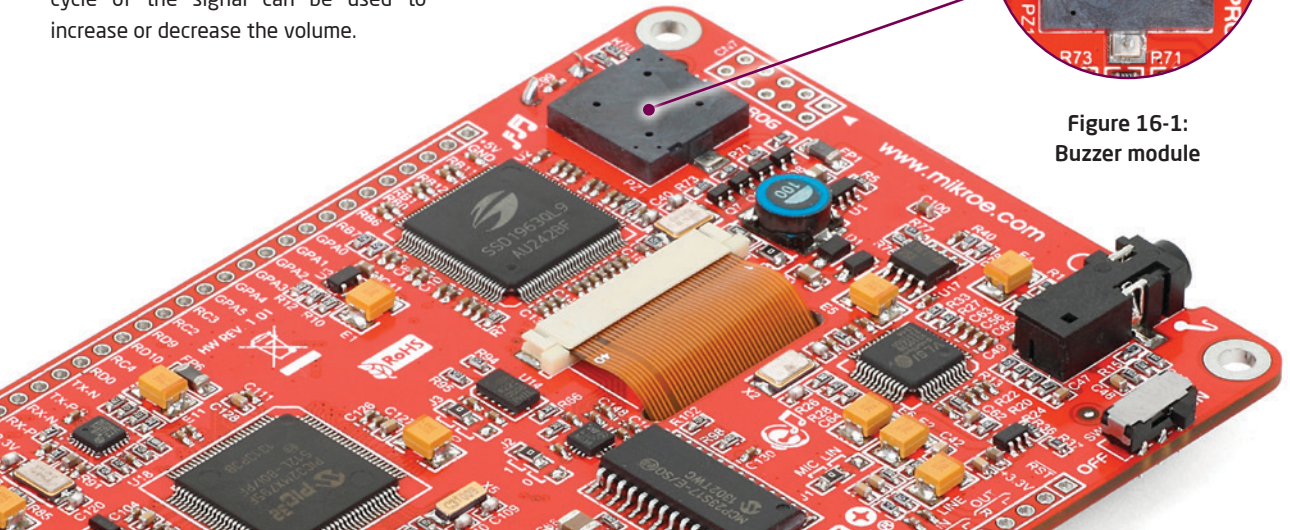

Figure 16-1:
Buzzer module



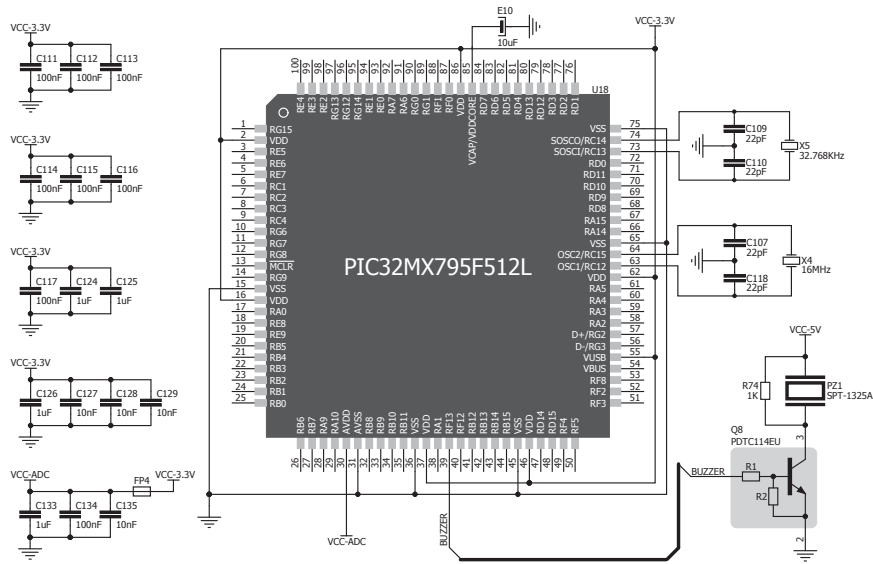
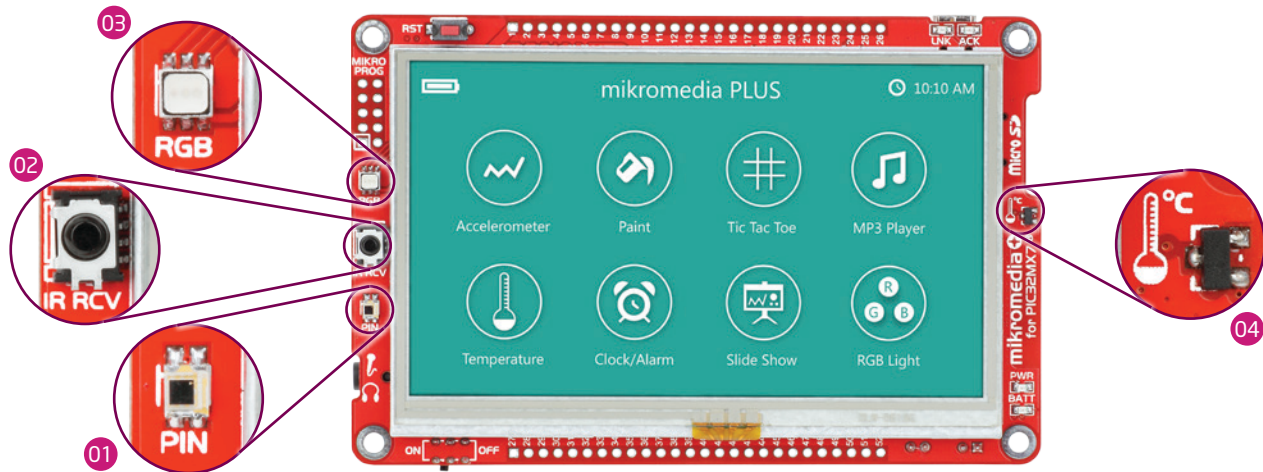

Figure 16-2: Buzzer module connection schematic

17. Other Modules



The board also contains other useful peripherals such as **01** PIN photodiode, **02** IR receiver, **03** RGB led diode and **04** analog temperature sensor. **PIN photodiode** is a type of photo detector. It has high sensitivity and response speed. It is connected to the microcontroller analog pin **RB8**. **IR receiver** is used in infrared remote control systems. The demodulated output signal obtained from IR module can be directly decoded by a microcontroller. Many of standard data formats are supported. **RGB (Red, Green, Blue) diode** can be used as a light indicator. Each color is driven separately by transistor. The **analog temperature sensor** converts temperature to analog voltage. It is directly connected to the microcontroller **RB9 analog pin**. Temperature measurement range of mikromedia+ for PIC32MX7[®] board is from -20° C to 70° C.

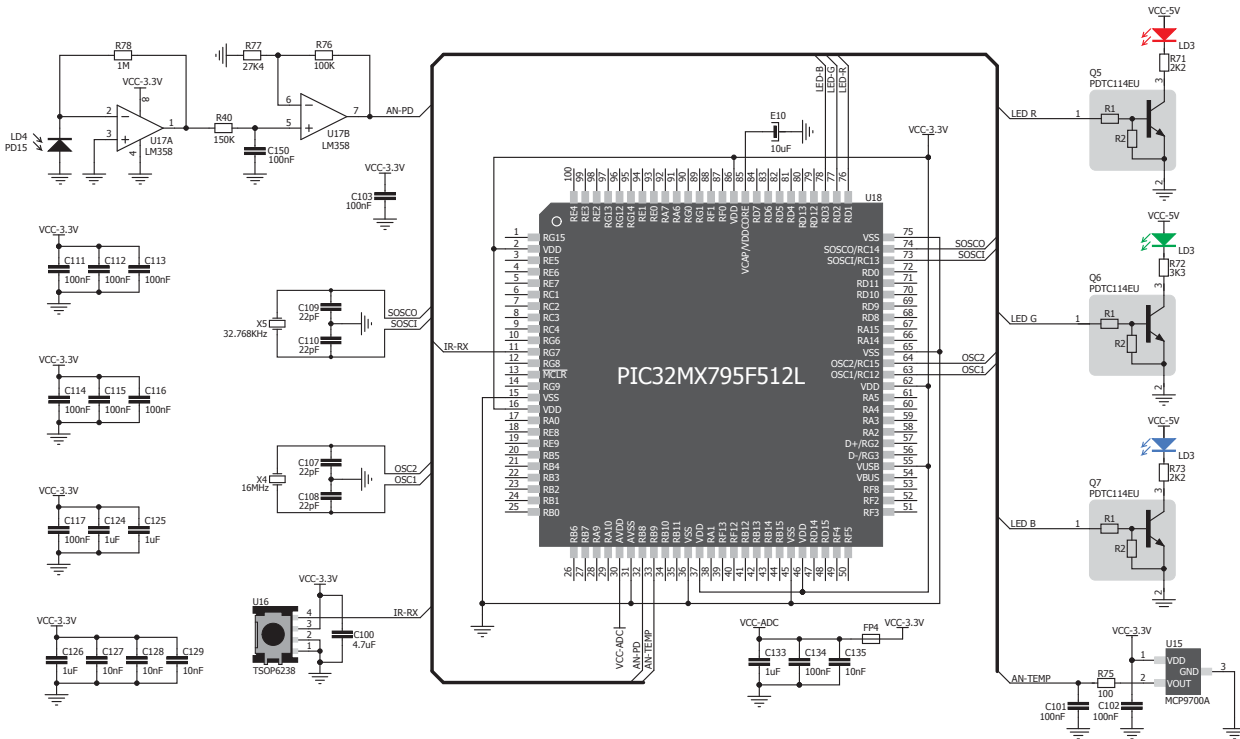
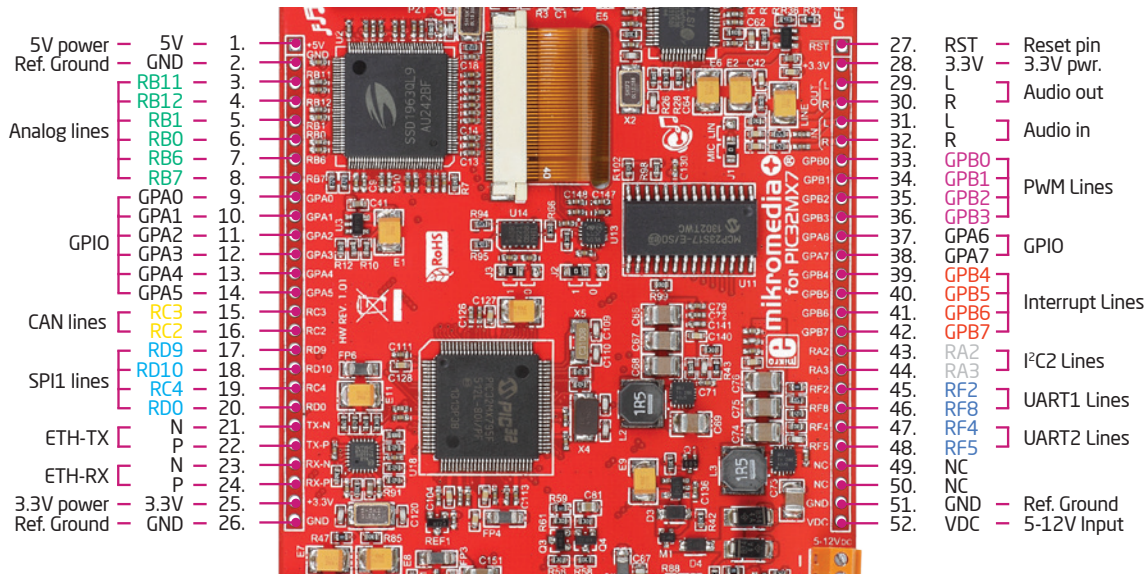

Figure 17-1: Other modules connection schematic

18. Pads

■ PWM
 ■ Interrupt
 ■ I2C
 ■ UART
 ■ Analog lines
 ■ SPI
 ■ CAN



Many microcontroller pins are available for further connectivity via two 1x26 rows of connection pads on both sides of the board. They are designed to match with the mikromedia+ SHIELD for PIC32MX7®

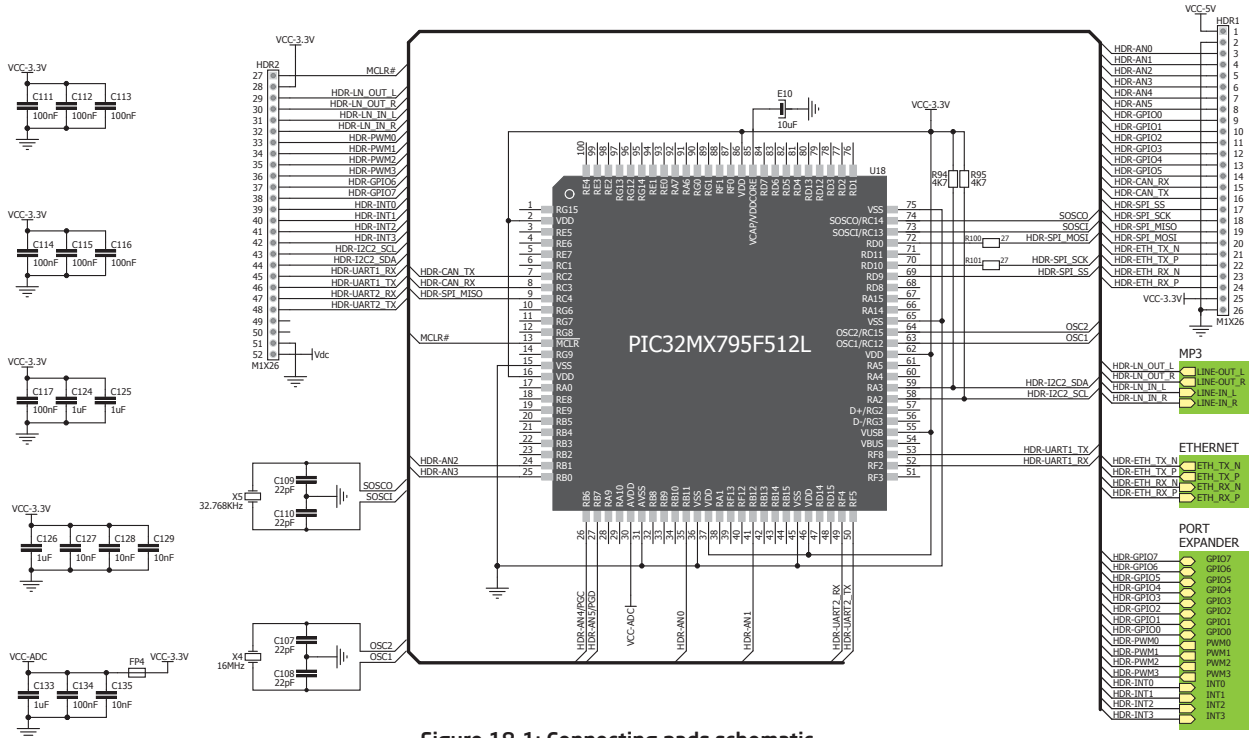
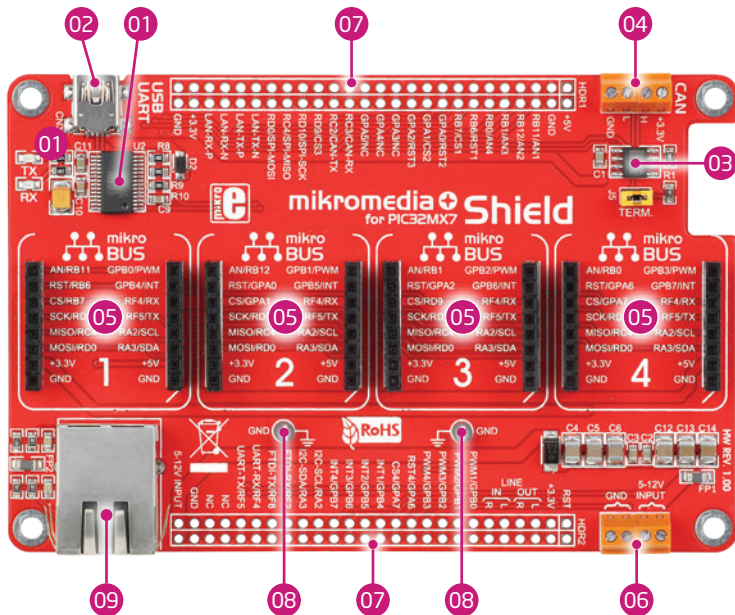

Figure 18-1: Connecting pads schematic

19. mikromedia+ SHIELD for PIC32MX7®



We have also made an extension board pin-compatible with your mikromedia+ board, which enables you to easily expand your basic board functionality. It is called **mikromedia+ SHIELD for PIC32MX7®**. The shield contains:

- 01 FTDI USB-UART chip
- 02 USB MINI-B connector
- 03 CAN transceiver
- 04 Screw terminals
- 05 mikroBUS sockets
- 06 Power supply screw terminals
- 07 Side connection pads
- 08 GNDs
- 09 Ethernet connector

Figure 19-1: mikromedia+ SHIELD for PIC32MX7*®

* not provided in the package

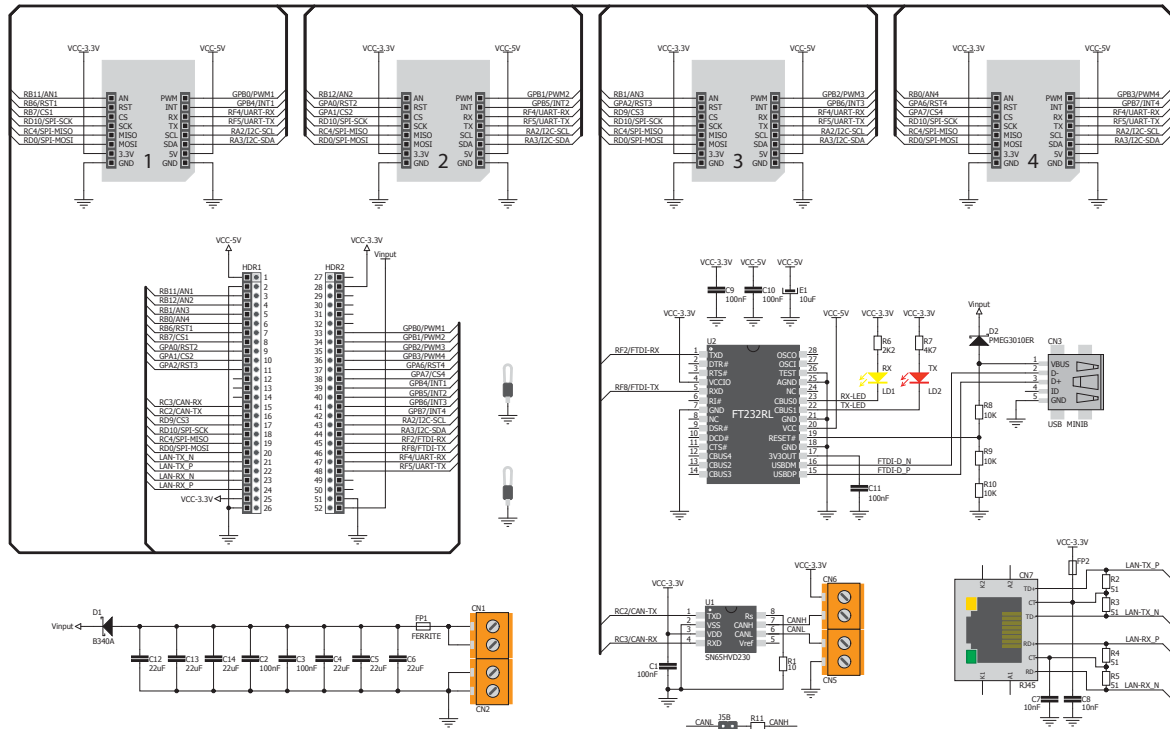

Figure 19-2: mikromedia+ SHIELD for PIC32MX7® schematic

20. Click boards are plug and play!

So far, MikroElektronika has released more than 60 mikroBUS™ compatible **click Boards™**. On average, one click board is released per week. Our intention is to enable you to easily expand with as many add-on boards as possible, so you will be able to easily expand the functionality of your development board. Each click board™ comes with a set of working example codes. Please, check the list of currently available boards on the following link:

<http://www.mikroe.com/click/>



EVE click™

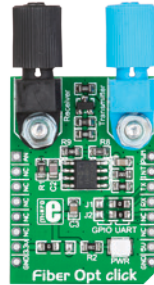

Fiber Opt click™



GPS2 click™



GSM2 click™

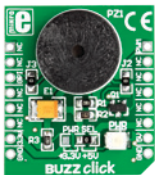

BUZZ click™

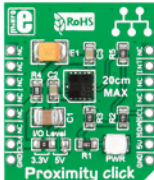

Proximity click™

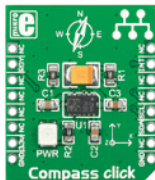

Compass click™

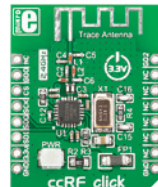

ccRF click™

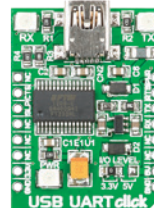

USB UART click™



Current click™

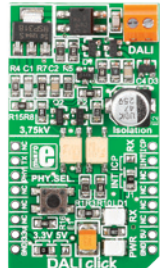

Dali click™

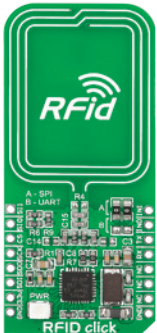

RFid click™



Relay click™

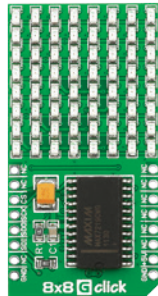

8x8 click™

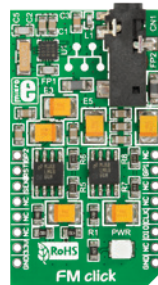

FM click™



Bluetooth2 click™

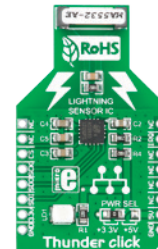

Thunder click™

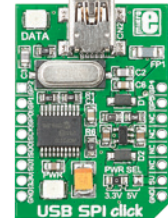

USB SPI click™

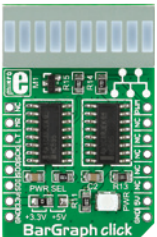

BarGraph click™

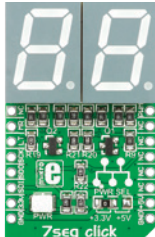

7seg click™

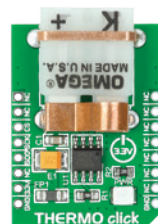

THERMO click™

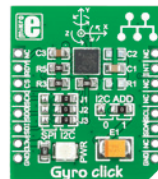

Gyro click™

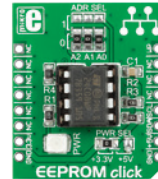

EEPROM click™

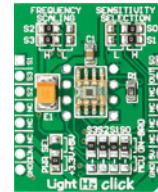

Light Hz click™

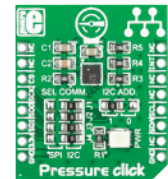

Pressure click™

21. Dimensions

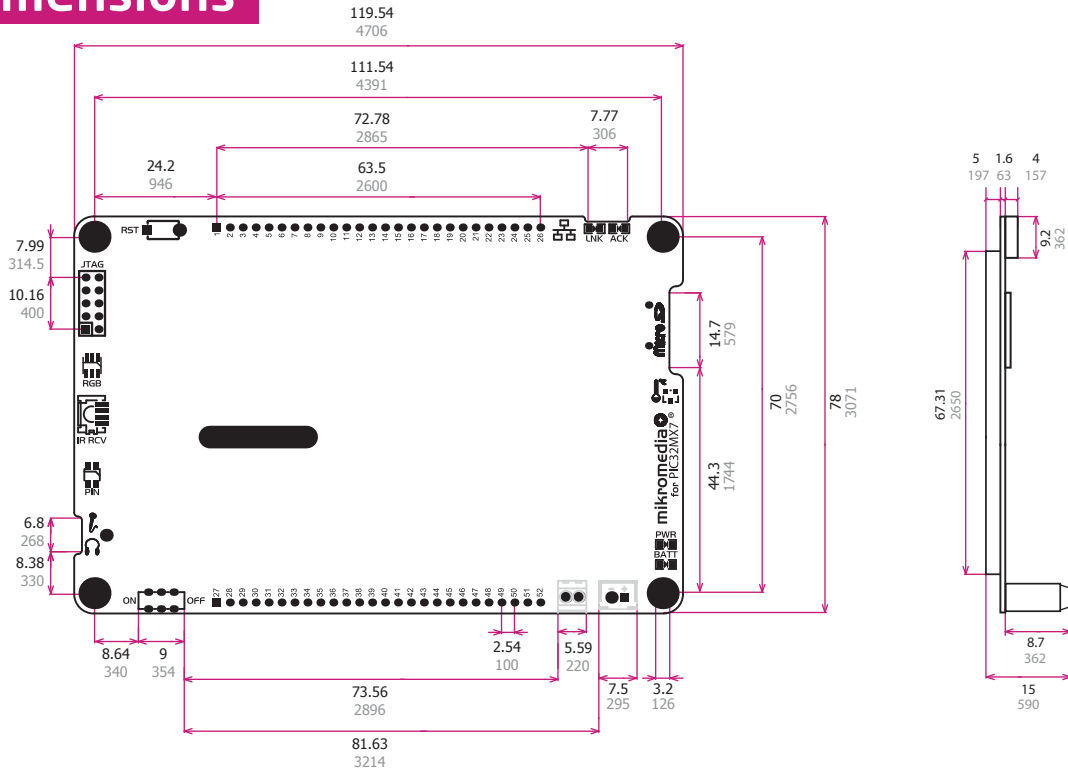

22. What's next?

Your journey through each and every feature of mikromedia+ for PIC32MX7® board ends here. You got to know it's modules and organization. Now you are ready to use it. We are suggesting several steps which are probably the best way to begin with. We invite you to join the users of mikromedia™ brand. You will find very useful projects and tutorials and can get help from a large ecosystem of users. Welcome!

Compiler

You still don't have an appropriate compiler? Locate PIC32® compiler that suits you best on our site:

<http://www.mikroe.com/pic/compilers/>

Choose between mikroC™, mikroBasic™ and mikroPascal™ and download fully functional demo version, so you can begin building your first applications.



Projects

Once you have chosen your compiler, and since you already got the board, you are ready to start writing your first projects. **Visual TFT software** for rapid development of graphical user interfaces enables you to quickly create your GUI. It will automatically create necessary code which is compatible with MikroElektronika compilers. Visual TFT is rich with examples, which are an excellent starting point for your future projects. Just load the example, read well commented code, and see how it works on hardware. Visual TFT is also available on our site:

<http://www.mikroe.com/visualtft/>

Notes:

DISCLAIMER

All the products owned by MikroElektronika are protected by copyright law and international copyright treaty. Therefore, this manual is to be treated as any other copyright material. No part of this manual, including product and software described herein, may be reproduced, stored in a retrieval system, translated or transmitted in any form or by any means, without the prior written permission of MikroElektronika. The manual PDF edition can be printed for private or local use, but not for distribution. Any modification of this manual is prohibited.

MikroElektronika provides this manual 'as is' without warranty of any kind, either expressed or implied, including, but not limited to, the implied warranties or conditions of merchantability or fitness for a particular purpose.

MikroElektronika shall assume no responsibility or liability for any errors, omissions and inaccuracies that may appear in this manual. In no event shall MikroElektronika, its directors, officers, employees or distributors be liable for any indirect, specific, incidental or consequential damages (including damages for loss of business profits and business information, business interruption or any other pecuniary loss) arising out of the use of this manual or product, even if MikroElektronika has been advised of the possibility of such damages. MikroElektronika reserves the right to change information contained in this manual at any time without prior notice, if necessary.

HIGH RISK ACTIVITIES

The products of MikroElektronika are not fault - tolerant nor designed, manufactured or intended for use or resale as on - line control equipment in hazardous environments requiring fail - safe performance, such as in the operation of nuclear facilities, aircraft navigation or communication systems, air traffic control, direct life support machines or weapons systems in which the failure of Software could lead directly to death, personal injury or severe physical or environmental damage ('High Risk Activities'). MikroElektronika and its suppliers specifically disclaim any expressed or implied warranty of fitness for High Risk Activities.

TRADEMARKS

The MikroElektronika name and logo, the MikroElektronika logo, mikroC™, mikroBasic™, mikroPascal™, mikroProg™, mikroBUS™, click Boards™, EasyPIC™ v7 and mikromedia™ are trademarks of MikroElektronika. All other trademarks mentioned herein are property of their respective companies.

All other product and corporate names appearing in this manual may or may not be registered trademarks or copyrights of their respective companies, and are only used for identification or explanation and to the owners' benefit, with no intent to infringe.



If you want to learn more about our products, please visit our website at www.mikroe.com

If you are experiencing some problems with any of our products or just need additional information, please place your ticket at www.mikroe.com/support/

If you have any questions, comments or business proposals,
do not hesitate to contact us at office@mikroe.com

mikromedia Plus for PIC32MX7 Manual
ver. 1.01b

