

## ANGELINA-XW-B

White version with ~91° wide beam compatible  
with BJB connectors

### TECHNICAL SPECIFICATIONS:

Dimensions	Ø 82 mm
Height	31 mm
Fastening	socket
Colour	white
Box size	480 x 280 x 300 mm
Box weight	11.1 kg
Quantity in Box	2035 pcs
ROHS compliant	yes ⓘ



### MATERIAL SPECIFICATIONS:

Component	Type	Material	Colour	Coating
ANGELINA-XW-B	Reflector	HRPC	white	

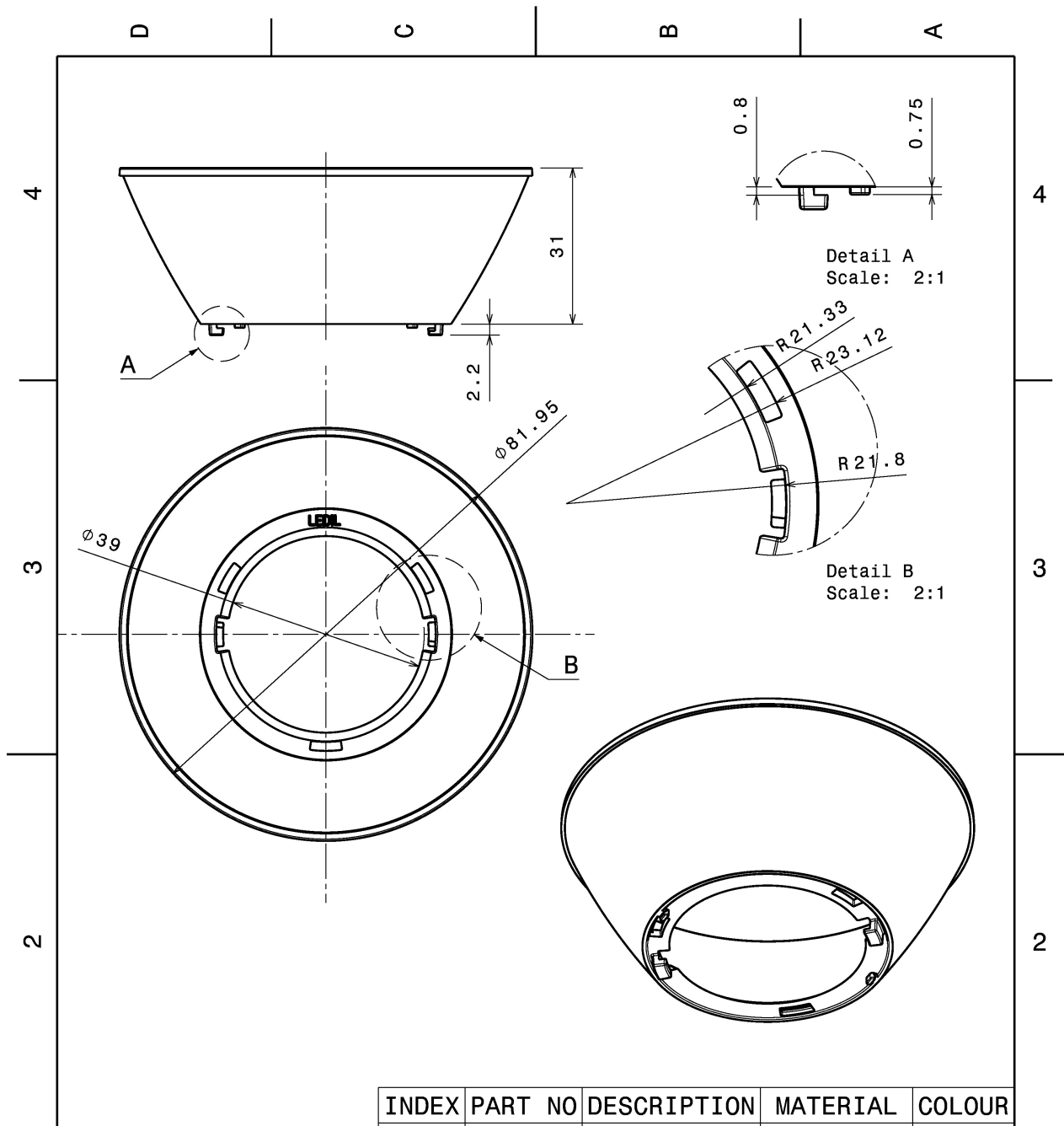

INDEX	PART NO	DESCRIPTION	MATERIAL	COLOUR
1		ANGELINA-B	Reflective PC	White

Tolerances if not otherwise shown  
According to DIN ISO 2768-1  
Linear measures:  
Up to 30mm class M, otherwise class C.  
According to DIN ISO 2768-2  
Form and position: class L

**LEDiL** Oy  
Salorankatu 10  
FIN 24240 SALO  
Finland

THIRD ANGLE PROJECTION:

DRAWING TITLE  
**ANGELINA-B series Reflector**

This drawing is the property of LEDiL Oy. It may not be reproduced, copied or communicated without a written agreement with LEDiL Oy."

SIZE	PART NUMBER
A4	-

SCALE	1:1	WEIGHT	-	SHEET	1/1
-------	-----	--------	---	-------	-----

### PHOTOMETRIC DATA (MEASURED):

 LED BXRA ES Rectangle FWHM 94.0° Efficiency 94 % Peak intensity 0.478 cd/lm Required components: BJB: 47.319.2040		
 LED V18 Gen7 FWHM 92.0° Efficiency 94 % Peak intensity 0.490 cd/lm Required components: BJB: 47.319.2350		
<b>CITIZEN</b> LED CLL03x/CLU03x FWHM 93.0° Efficiency 94 % Peak intensity 0.500 cd/lm Required components: BJB: 47.319.2021		
<b>CITIZEN</b> LED CLL03x/CLU03x FWHM 93.0° Efficiency 89 % Peak intensity 0.450 cd/lm Required components: F13671_ANGE-RZ-LENS A.A.G. STUCCHI: 8101/G2		

**PHOTOMETRIC DATA (MEASURED):**

**CITIZEN**

LED            CLL03x/CLU03x  
FWHM         93.0°  
Efficiency     94 %  
Peak intensity 0.490 cd/lm  
Required components:  
A.A.G. STUCCHI: 8101/G2

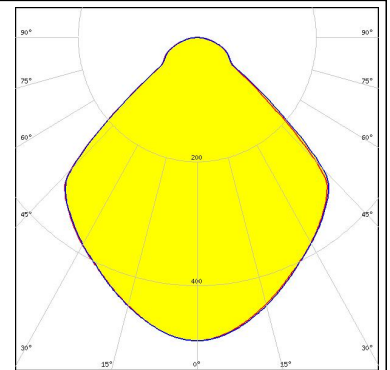
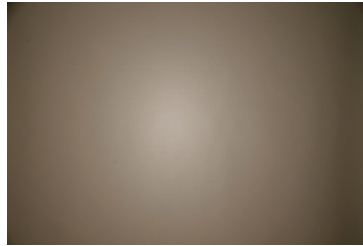

**CITIZEN**

LED            CLL04x/CLU04x  
FWHM         92.0°  
Efficiency     94 %  
Peak intensity 0.480 cd/lm  
Required components:  
A.A.G. STUCCHI: 8102/G2

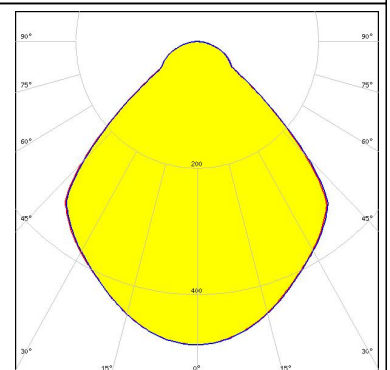
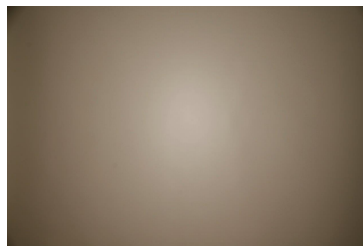

**CITIZEN**

LED            CLL04x/CLU04x  
FWHM         91.0°  
Efficiency     88 %  
Peak intensity 0.450 cd/lm  
Required components:  
F13671\_ANGE-RZ-LENS  
A.A.G. STUCCHI: 8102/G2

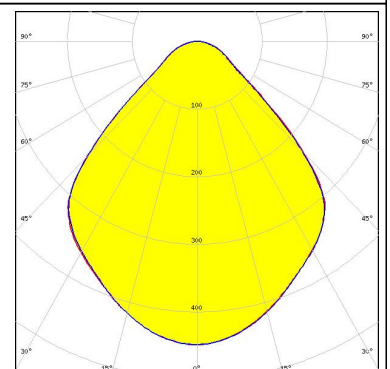
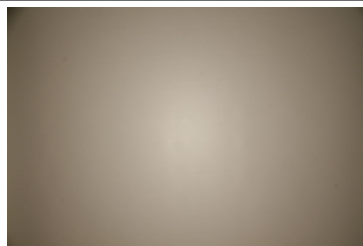

**CITIZEN**

LED            CLL04x/CLU04x  
FWHM         91.0°  
Efficiency     94 %  
Peak intensity 0.500 cd/lm  
Required components:  
BJB: 47.319.2030

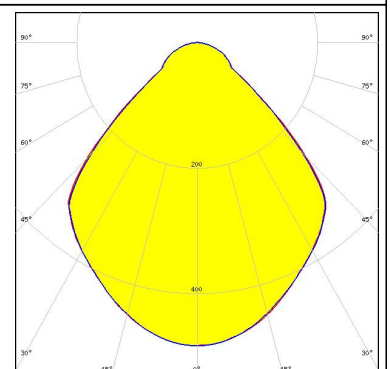
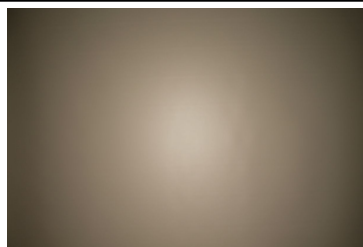



#### PHOTOMETRIC DATA (MEASURED):



LED CXA/B 25xx  
 FWHM 92.0°  
 Efficiency 94 %  
 Peak intensity 0.490 cd/lm  
 Required components:  
 BJB: 47.319.2141

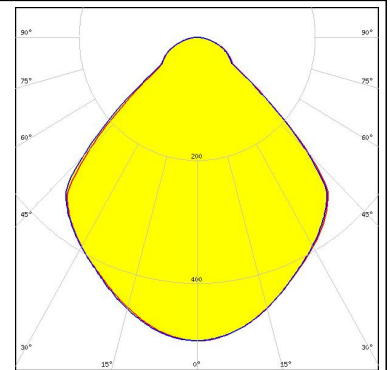
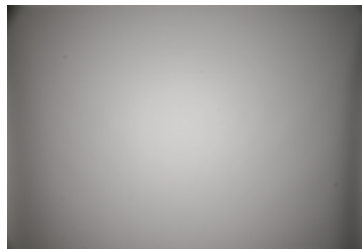

LED CXA/B 25xx  
 FWHM 92.0°  
 Efficiency 92 %  
 Peak intensity 0.460 cd/lm  
 Required components:  
 F13671\_ANGE-RZ-LENS  
 BJB: 47.319.2141

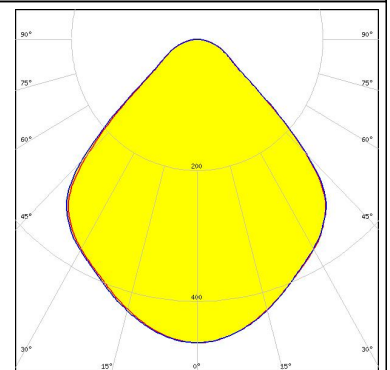
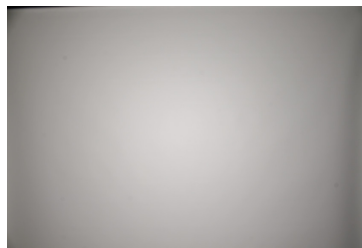

LED CXA/B 25xx  
 FWHM 93.0°  
 Efficiency 94 %  
 Peak intensity 0.490 cd/lm  
 Required components:  
 A.A.G. STUCCHI: 8401/G2

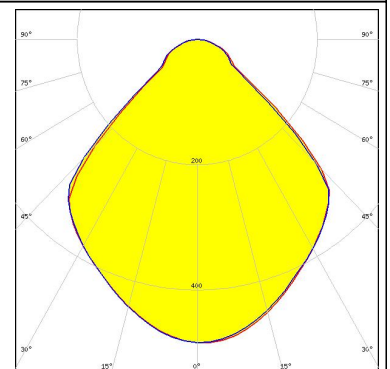
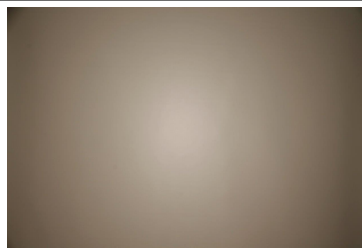

LED CXA/B 30xx  
 FWHM 90.0°  
 Efficiency 94 %  
 Peak intensity 0.490 cd/lm  
 Required components:  
 A.A.G. STUCCHI: 8404/G2

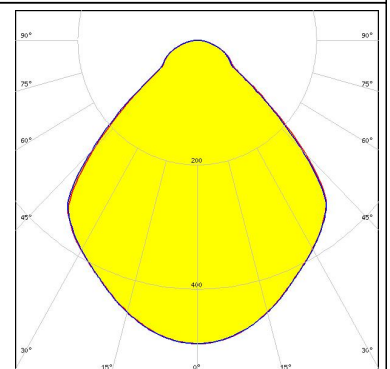
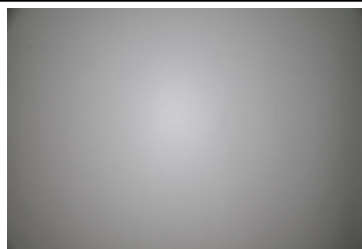

**PHOTOMETRIC DATA (MEASURED):**

**LG Innotek**

LED COB 10W/13W/17W/24W  
 FWHM 93.0°  
 Efficiency 94 %  
 Peak intensity 0.490 cd/lm  
 Required components:  
 A.A.G. STUCCHI: 8600/G2

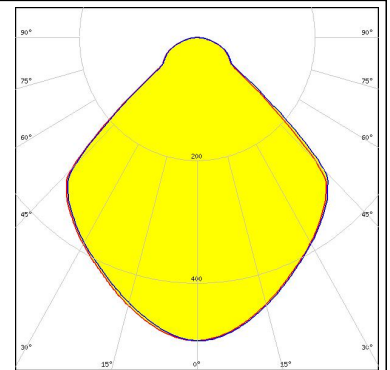
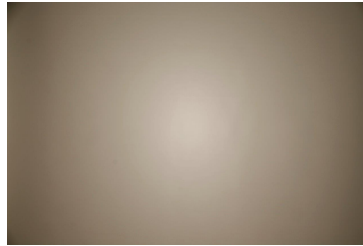

**LG Innotek**

LED COB 10W/13W/17W/24W  
 FWHM 93.0°  
 Efficiency 94 %  
 Peak intensity 0.500 cd/lm  
 Required components:  
 BJB: 47.319.2080

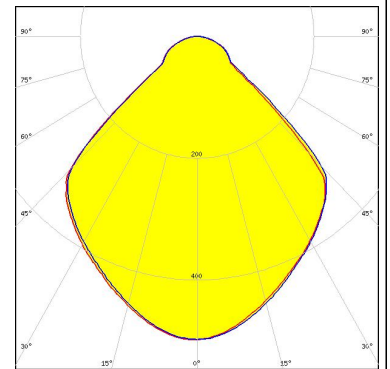

**LG Innotek**

LED COB 40W/60W  
 FWHM 90.0°  
 Efficiency 94 %  
 Peak intensity 0.490 cd/lm  
 Required components:  
 A.A.G. STUCCHI: 8102/G2

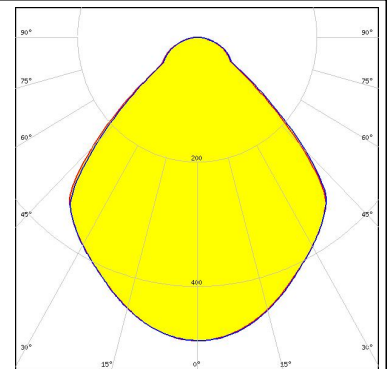
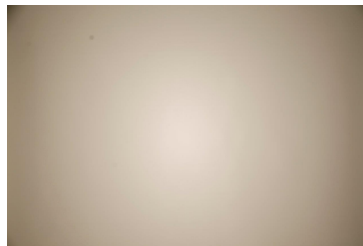

**LUMILEDS**

LED LUXEON CoB 1204/1205  
 FWHM 94.0°  
 Efficiency 94 %  
 Peak intensity 0.490 cd/lm  
 Required components:  
 A.A.G. STUCCHI: 8301/G2

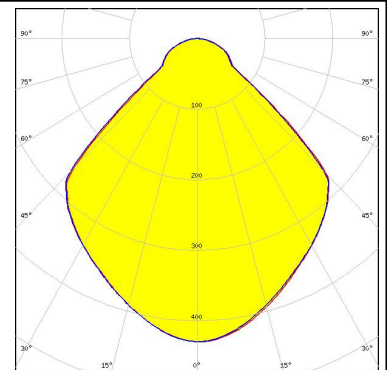
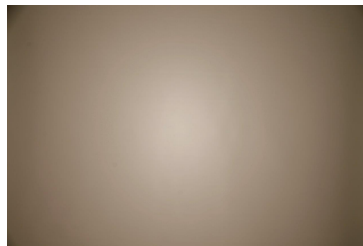

**PHOTOMETRIC DATA (MEASURED):**

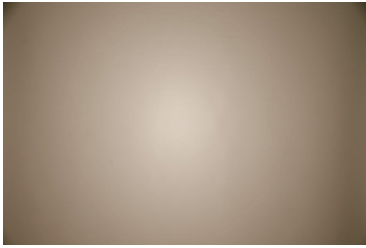
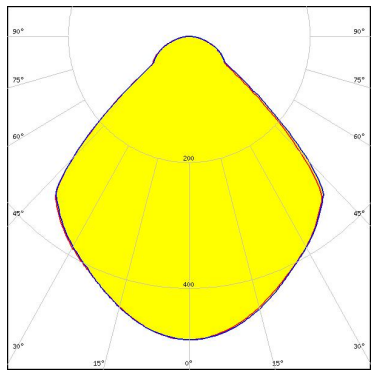
<p><b>LUMILEDS</b></p> <p>LED LUXEON CoB 1208</p> <p>FWHM 93.0°</p> <p>Efficiency 94 %</p> <p>Peak intensity 0.490 cd/lm</p> <p>Required components: A.A.G. STUCCHI: 8301/G2</p>		
<p><b>LUMILEDS</b></p> <p>LED LUXEON CoB 1211</p> <p>FWHM 92.0°</p> <p>Efficiency 94 %</p> <p>Peak intensity 0.480 cd/lm</p> <p>Required components: BJB: 47.319.2030</p>		
<p><b>LUMILEDS</b></p> <p>LED LUXEON CoB 1211</p> <p>FWHM 91.0°</p> <p>Efficiency 94 %</p> <p>Peak intensity 0.490 cd/lm</p> <p>Required components: A.A.G. STUCCHI: 8102/G2</p>		
<p><b>LUMILEDS</b></p> <p>LED LUXEON CoB 1216/1812</p> <p>FWHM 91.0°</p> <p>Efficiency 96 %</p> <p>Peak intensity 0.490 cd/lm</p> <p>Required components: BJB: 47.319.2030</p>		

**PHOTOMETRIC DATA (MEASURED):**

**LUMILEDS**

LED LUXEON CoB 1216/1812  
 FWHM 91.0°  
 Efficiency 89 %  
 Peak intensity 0.490 cd/lm  
 Required components:  
 F13671\_ANGE-RZ-LENS  
 BJB: 47.319.2030

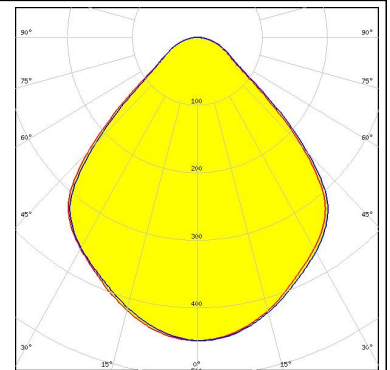

**LUMILEDS**

LED LUXEON K12  
 FWHM 91.0°  
 Efficiency 94 %  
 Peak intensity 0.533 cd/lm  
 Required components:  
 BJB: 47.319.2070

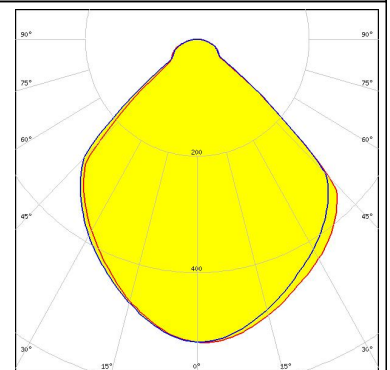

**LUMILEDS**

LED LUXEON K16  
 FWHM 91.0°  
 Efficiency 94 %  
 Peak intensity 0.540 cd/lm  
 Required components:  
 BJB: 47.319.2070

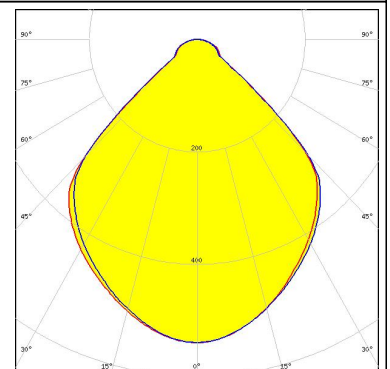
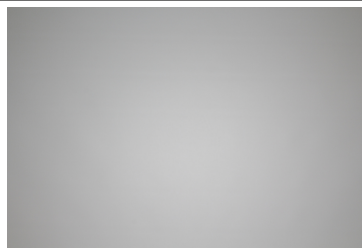

**LUMINUS**

LED CXM-14  
 FWHM 92.0°  
 Efficiency 94 %  
 Peak intensity 0.500 cd/lm  
 Required components:  
 BJB: 47.319.2021

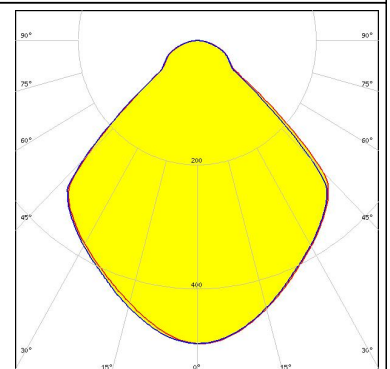
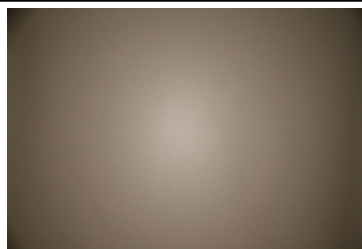

**PHOTOMETRIC DATA (MEASURED):**

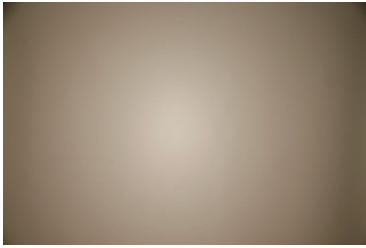
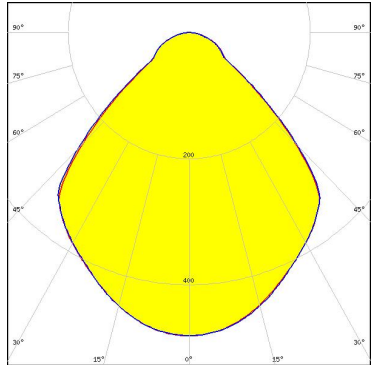
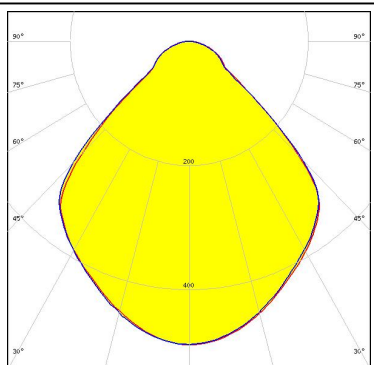
<p><b>LUMINUS</b></p> <p>LED CXM-22            FWHM 91.0°            Efficiency 94 %            Peak intensity 0.500 cd/lm            Required components:            BJB: 47.319.2030</p>		
<p><b>OSRAM</b> Opto Semiconductors</p> <p>LED Soleriq E30            FWHM 91.0°            Efficiency 94 %            Peak intensity 0.490 cd/lm            Required components:            BJB: 47.319.2090</p>		
<p><b>OSRAM</b> Opto Semiconductors</p> <p>LED Soleriq P13            FWHM 93.0°            Efficiency 94 %            Peak intensity 0.490 cd/lm            Required components:            A.A.G. STUCCHI: 8502/G2</p>		
<p><b>OSRAM</b> Opto Semiconductors</p> <p>LED Soleriq S13 Gen2            FWHM 94.0°            Efficiency 94 %            Peak intensity 0.470 cd/lm            Required components:            BJB: 47.319.2021</p>		



**PHOTOMETRIC DATA (MEASURED):**

**OSRAM**  
Opto Semiconductors

LED Soleriq S19  
FWHM 92.0°  
Efficiency 94 %  
Peak intensity 0.490 cd/lm  
Required components:  
A.A.G. STUCCHI: 8503/G2

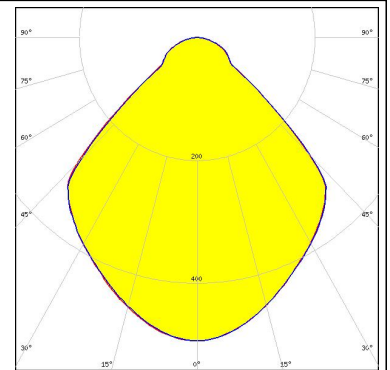
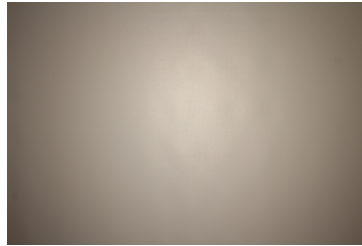

**OSRAM**  
Opto Semiconductors

LED Soleriq S19  
FWHM 93.0°  
Efficiency 94 %  
Peak intensity 0.480 cd/lm  
Required components:  
BJB: 47.319.2170

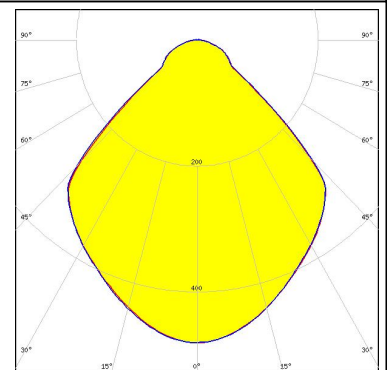
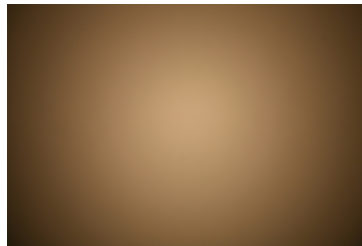

**SAMSUNG**

LED COB D Series LES 14.5 mm  
FWHM 93.0°  
Efficiency 94 %  
Peak intensity 0.490 cd/lm  
Required components:  
A.A.G. STUCCHI: 8101/G2

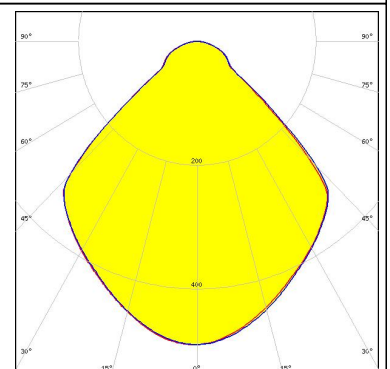
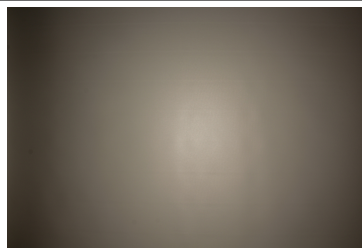

**SAMSUNG**

LED COB D Series LES 14.5 mm  
FWHM 93.0°  
Efficiency 91 %  
Peak intensity 0.460 cd/lm  
Required components:  
F13671\_ANGE-RZ-LENS  
A.A.G. STUCCHI: 8101/G2

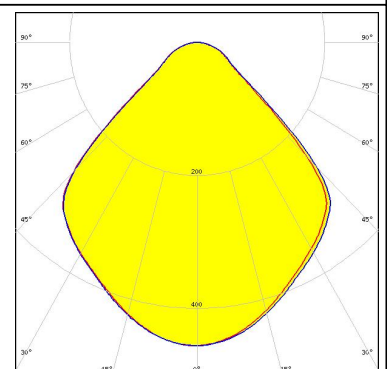
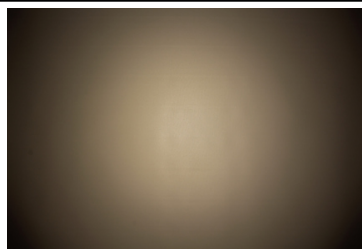



**PHOTOMETRIC DATA (MEASURED):**

**SAMSUNG**

LED COB D Series LES 14.5 mm  
 FWHM 93.0°  
 Efficiency 94 %  
 Peak intensity 0.490 cd/lm  
 Required components:  
 BJB: 47.319.2021

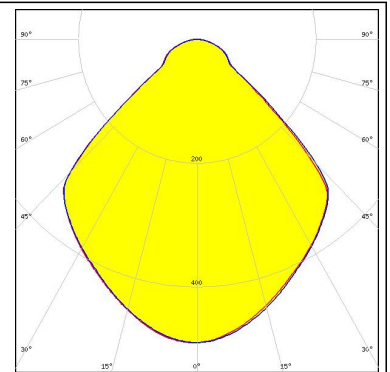
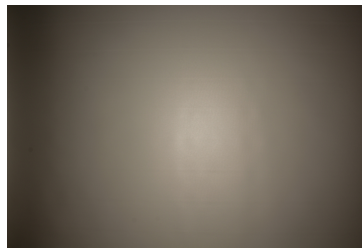

**SAMSUNG**

LED COB D Series LES 14.5 mm  
 FWHM 93.0°  
 Efficiency 91 %  
 Peak intensity 0.460 cd/lm  
 Required components:  
 F13671\_ANGE-RZ-LENS  
 BJB: 47.319.2021

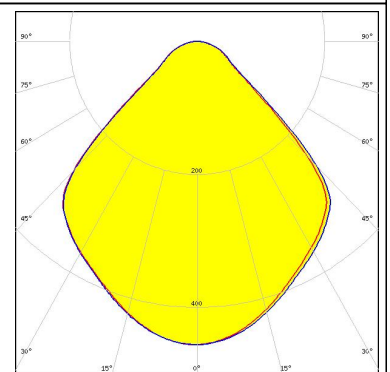
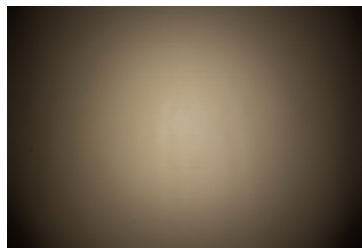

LED ZC12/18  
 FWHM 93.0°  
 Efficiency 94 %  
 Peak intensity 0.490 cd/lm  
 Required components:  
 A.A.G. STUCCHI: 8101/G2

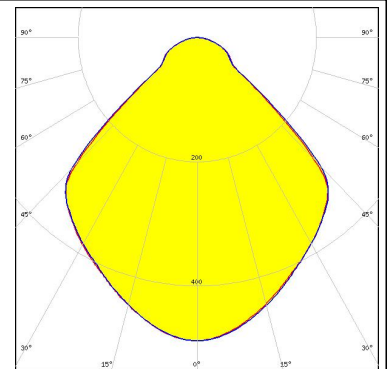
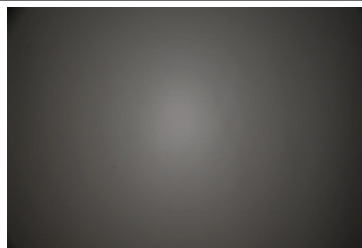

LED ZC25/40/60  
 FWHM 91.0°  
 Efficiency 94 %  
 Peak intensity 0.480 cd/lm  
 Required components:  
 A.A.G. STUCCHI: 8102/G2

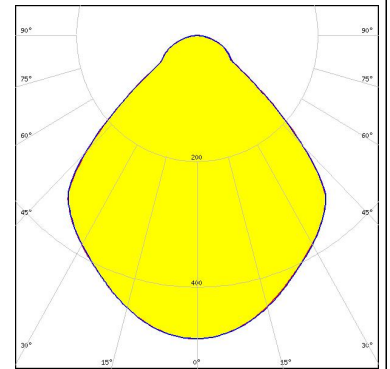
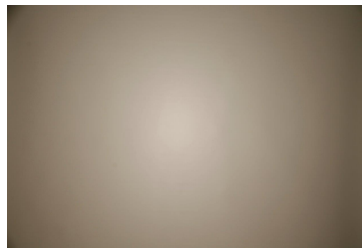

### PHOTOMETRIC DATA (MEASURED):

#### SHARP

LED Mega Zenigata (GW5DGC)  
FWHM 93.0°  
Efficiency 94 %  
Peak intensity 0.480 cd/lm  
Required components:  
BJB: 47.319.2011

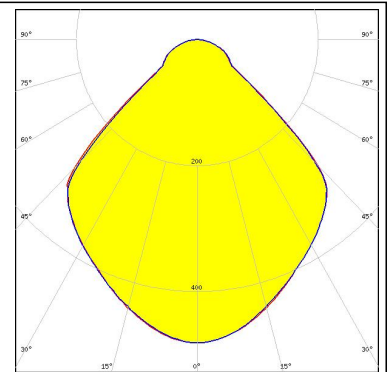
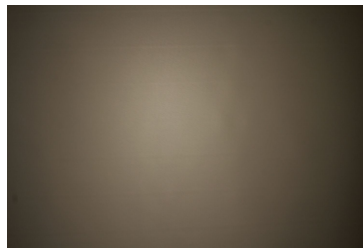

#### SHARP

LED Mega Zenigata (GW6DME)  
FWHM 93.0°  
Efficiency 94 %  
Peak intensity 0.480 cd/lm  
Required components:  
BJB: 47.319.2011

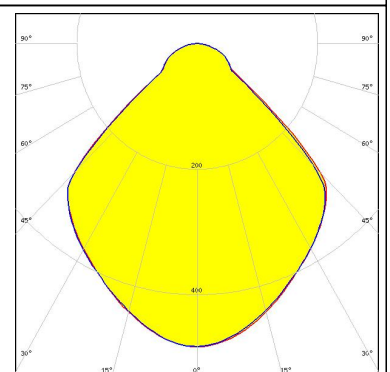
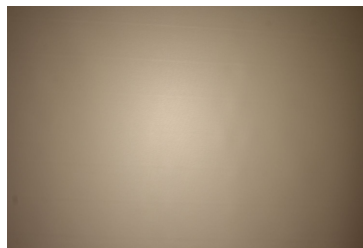

#### SHARP

LED Mega Zenigata (GW6DME)  
FWHM 93.0°  
Efficiency 94 %  
Peak intensity 0.500 cd/lm  
Required components:  
A.A.G. STUCCHI: 8301/G2

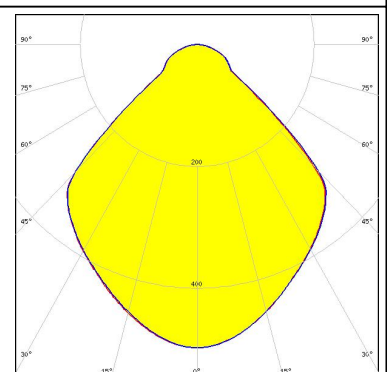
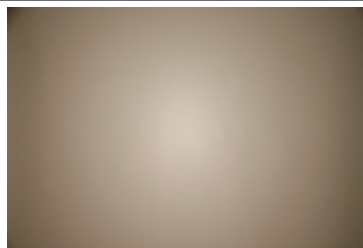

### PHOTOMETRIC DATA (SIMULATED):

#### CITIZEN

LED CLU730/731  
FWHM 86.0°  
Efficiency 93 %  
Peak intensity 0.635 cd/lm  
Required components:  
BJB: 47.319.2030

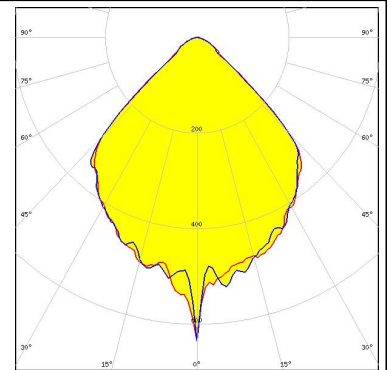

#### SAMSUNG

LED COB D Series LES 22 mm  
FWHM 91.0°  
Efficiency 88 %  
Peak intensity 0.460 cd/lm  
Required components:  
BJB: 47.319.2030

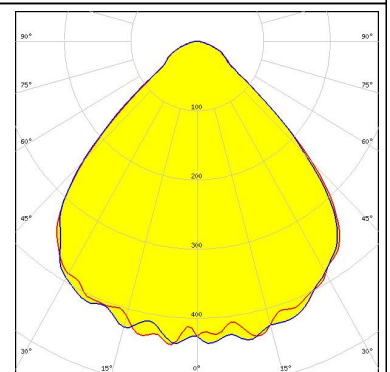

#### TRIDONIC

LED SLE G6 LES15  
FWHM 94.0°  
Efficiency 93 %  
Peak intensity 0.450 cd/lm  
Required components:  
BJB: 47.319.2021

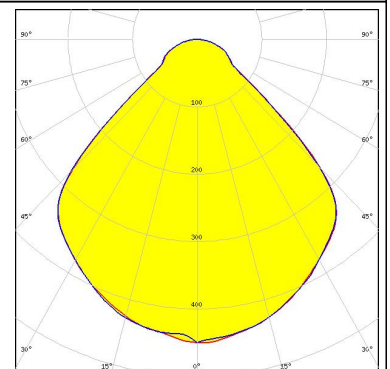

#### GENERAL INFORMATION:

NOTE: The typical beam angle will be changed by different color, chip size and chip position tolerance. The typical total beam angle is the full angle measured where the luminous intensity is half of the peak value.

Due to use of high power COB's with this product, special attention to proper thermal design is highly recommended. LEDiL has no liability for direct, indirect or consecutive damages arising from the LEDiL products being used outside of the recommended temperature range.

#### MATERIALS:

As part of our continuous research and improvement processes, and to ensure the best possible quality and availability of our products, LEDiL reserves the right to change material grades without notice.

#### PRODUCT DATA USER AGREEMENT AND DISCLAIMER:

The measured data in the provided downloadable LEDiL Product Datasheets and Mechanical 2D-Drawings is rounded and provided as reference for planning. LEDiL Oy's optical specifications have been verified by conducting performance testing of the products in accordance with the company's quality system. The reported data are averaged results of multiple measurements with typical variation. LEDiL Oy reserves the right to without prior notification make changes and improvements to its products.

LEDiL Oy assumes neither warranty, nor guarantee nor any other liability of any kind for the contents and correctness of the provided data. The provided data has been generated with highest diligence but the provided data may in reality not represent the complete possible variation range of all intrinsic parameters. Therefore, in certain cases a deviation from the provided data could occur.

LEDiL Oy reserves the right to undertake technical changes of its products without further notification which could lead to changes in the provided data. LEDiL Oy assumes no liability of any kind for the possible deviation from any provided data or any other damage resulting from the usage of the provided data.

The user agrees to this disclaimer and user agreement with the download or usage of the provided files.

#### LEDiL Oy

Joensuunkatu 13  
FI-24240 SALO  
Finland

#### LEDiL Inc.

228 West Page Street  
Suite D  
Sycamore IL 60178  
USA

#### Local sales and technical support

[www.ledil.com/where\\_to\\_buy](http://www.ledil.com/where_to_buy)

#### Shipping locations

Salo, Finland  
Hong Kong, China

#### Distribution Partners

[www.ledil.com/where\\_to\\_buy](http://www.ledil.com/where_to_buy)