

Applications

- High Frequency Isolated DC-DC Converters with Synchronous Rectification for Telecom and Industrial Use
- High Frequency Buck Converters for Computer Processor Power

V_{DSS}	R_{DS(on)} max	I_D
20V	20mΩ	36A

Benefits

- Ultra-Low Gate Impedance
- Very Low R_{DS(on)} at 4.5V V_{GS}
- Fully Characterized Avalanche Voltage and Current

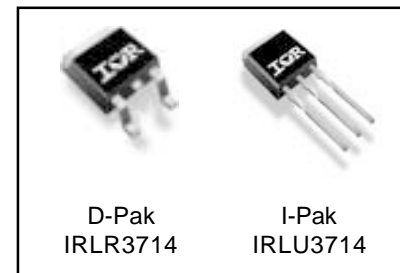

Absolute Maximum Ratings

Symbol	Parameter	Max.	Units
V _{DS}	Drain-Source Voltage	20	V
V _{GS}	Gate-to-Source Voltage	± 20	V
I _D @ T _C = 25°C	Continuous Drain Current, V _{GS} @ 10V	36 ⑤	A
I _D @ T _C = 70°C	Continuous Drain Current, V _{GS} @ 10V	31	
I _{DM}	Pulsed Drain Current①	140	
P _D @ T _C = 25°C	Maximum Power Dissipation③	47	W
P _D @ T _C = 70°C	Maximum Power Dissipation③	33	W
	Linear Derating Factor	0.31	W/°C
T _J , T _{STG}	Junction and Storage Temperature Range	-55 to + 175	°C

Thermal Resistance

	Parameter	Typ.	Max.	Units
R _{θJC}	Junction-to-Case	—	3.2	°C/W
R _{θJA}	Junction-to-Ambient	—	50	
R _{θJA}	Junction-to-Ambient (PCB mount)④	—	110	

Notes ① through ⑤ are on page 10

IRLR3714/IRLU3714

International
IR Rectifier

Static @ $T_J = 25^\circ\text{C}$ (unless otherwise specified)

	Parameter	Min.	Typ.	Max.	Units	Conditions
$V_{(BR)DSS}$	Drain-to-Source Breakdown Voltage	20	—	—	V	$V_{GS} = 0V, I_D = 250\mu A$
$\Delta V_{(BR)DSS}/\Delta T_J$	Breakdown Voltage Temp. Coefficient	—	0.022	—	V/ $^\circ\text{C}$	Reference to $25^\circ\text{C}, I_D = 1mA$
$R_{DS(on)}$	Static Drain-to-Source On-Resistance	—	15	20	m Ω	$V_{GS} = 10V, I_D = 18A$ ③
		—	21	28		$V_{GS} = 4.5V, I_D = 14A$ ③
$V_{GS(th)}$	Gate Threshold Voltage	1.0	—	3.0	V	$V_{DS} = V_{GS}, I_D = 250\mu A$
I_{DSS}	Drain-to-Source Leakage Current	—	—	20	μA	$V_{DS} = 16V, V_{GS} = 0V$
		—	—	100		$V_{DS} = 16V, V_{GS} = 0V, T_J = 125^\circ\text{C}$
I_{GSS}	Gate-to-Source Forward Leakage	—	—	200	nA	$V_{GS} = 16V$
	Gate-to-Source Reverse Leakage	—	—	-200		$V_{GS} = -16V$

Dynamic @ $T_J = 25^\circ\text{C}$ (unless otherwise specified)

Symbol	Parameter	Min.	Typ.	Max.	Units	Conditions
g_{fs}	Forward Transconductance	17	—	—	S	$V_{DS} = 10V, I_D = 14A$
Q_g	Total Gate Charge	—	6.5	9.7	nC	$I_D = 14A$
Q_{gs}	Gate-to-Source Charge	—	1.8	—		$V_{DS} = 10V$
Q_{gd}	Gate-to-Drain ("Miller") Charge	—	2.9	—		$V_{GS} = 4.5V$
Q_{oss}	Output Gate Charge	—	7.1	—		$V_{GS} = 0V, V_{DS} = 10V$
$t_{d(on)}$	Turn-On Delay Time	—	8.7	—	ns	$V_{DD} = 10V$
t_r	Rise Time	—	78	—		$I_D = 14A$
$t_{d(off)}$	Turn-Off Delay Time	—	10	—		$R_G = 1.8\Omega$
t_f	Fall Time	—	4.5	—		$V_{GS} = 4.5V$ ③
C_{iss}	Input Capacitance	—	670	—	pF	$V_{GS} = 0V$
C_{oss}	Output Capacitance	—	470	—		$V_{DS} = 10V$
C_{rss}	Reverse Transfer Capacitance	—	68	—		$f = 1.0MHz$

Avalanche Characteristics

Symbol	Parameter	Typ.	Max.	Units
E_{AS}	Single Pulse Avalanche Energy②	—	72	mJ
I_{AR}	Avalanche Current①	—	14	A

Diode Characteristics

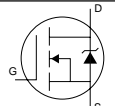
Symbol	Parameter	Min.	Typ.	Max.	Units	Conditions
I_S	Continuous Source Current (Body Diode)	—	36⑤	—	A	MOSFET symbol showing the integral reverse p-n junction diode. 
I_{SM}	Pulsed Source Current (Body Diode) ①	—	140	—		
V_{SD}	Diode Forward Voltage	—	—	1.3	V	$T_J = 25^\circ\text{C}, I_S = 18A, V_{GS} = 0V$ ③
		—	0.88	—		$T_J = 125^\circ\text{C}, I_S = 18A, V_{GS} = 0V$ ③
t_{rr}	Reverse Recovery Time	—	35	53	ns	$T_J = 25^\circ\text{C}, I_F = 18A, V_R = 10V$
Q_{rr}	Reverse Recovery Charge	—	34	51	nC	$di/dt = 100A/\mu s$ ③
t_{rr}	Reverse Recovery Time	—	35	53	ns	$T_J = 125^\circ\text{C}, I_F = 18A, V_R = 10V$
Q_{rr}	Reverse Recovery Charge	—	35	53	nC	$di/dt = 100A/\mu s$ ③

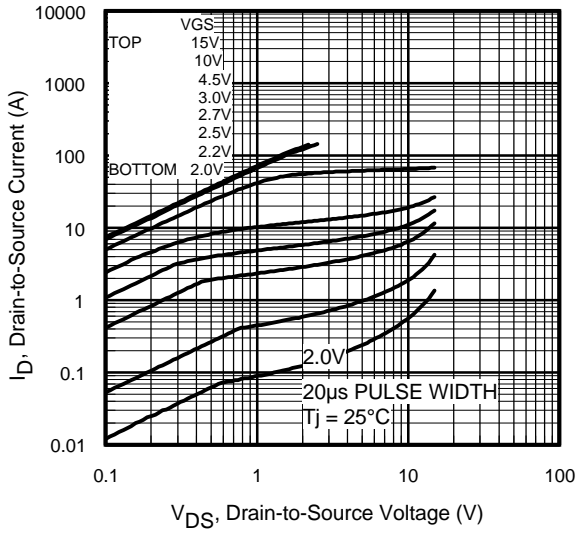

Fig 1. Typical Output Characteristics

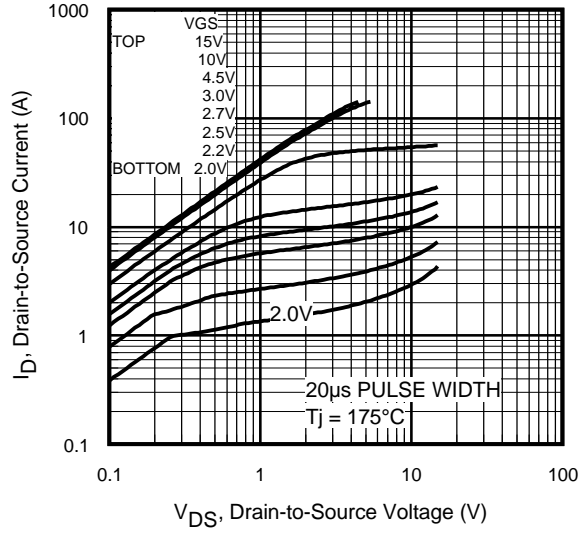

Fig 2. Typical Output Characteristics

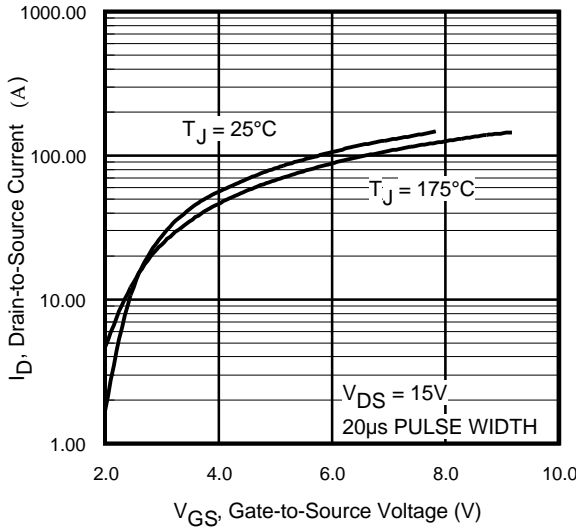

Fig 3. Typical Transfer Characteristics

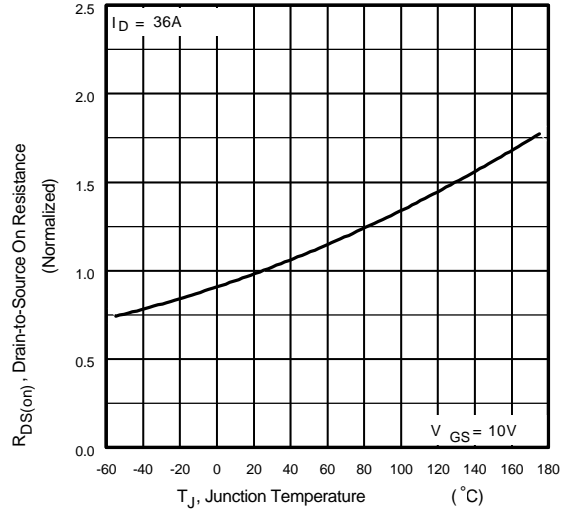

Fig 4. Normalized On-Resistance Vs. Temperature

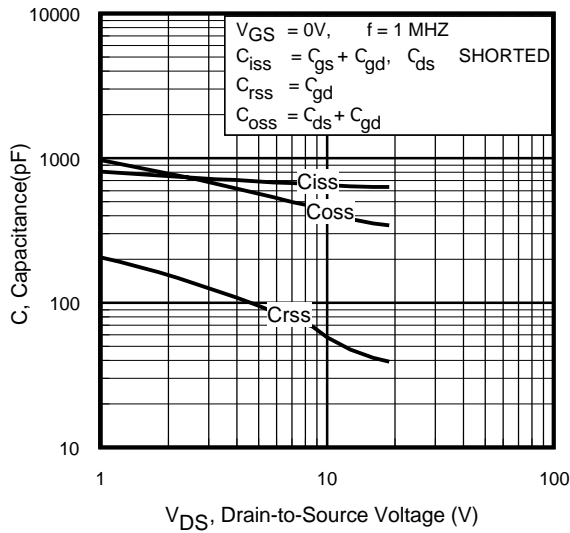

Fig 5. Typical Capacitance Vs. Drain-to-Source Voltage

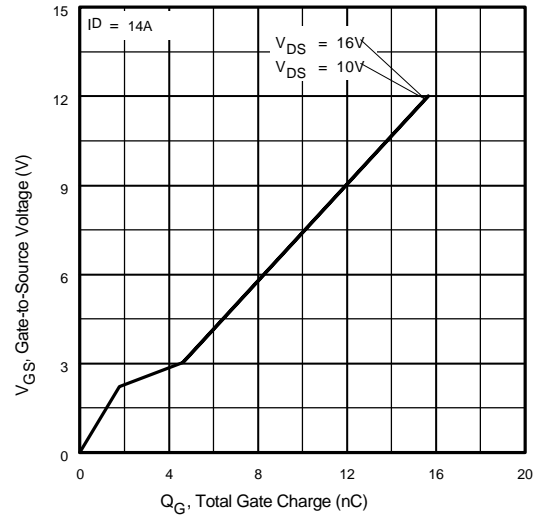

Fig 6. Typical Gate Charge Vs. Gate-to-Source Voltage

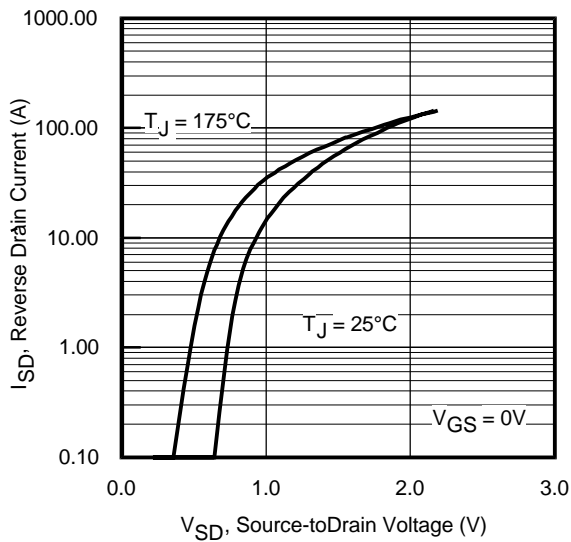

Fig 7. Typical Source-Drain Diode Forward Voltage

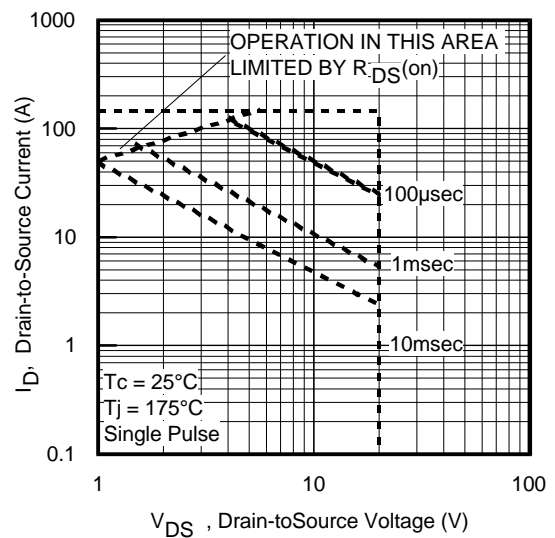

Fig 8. Maximum Safe Operating Area

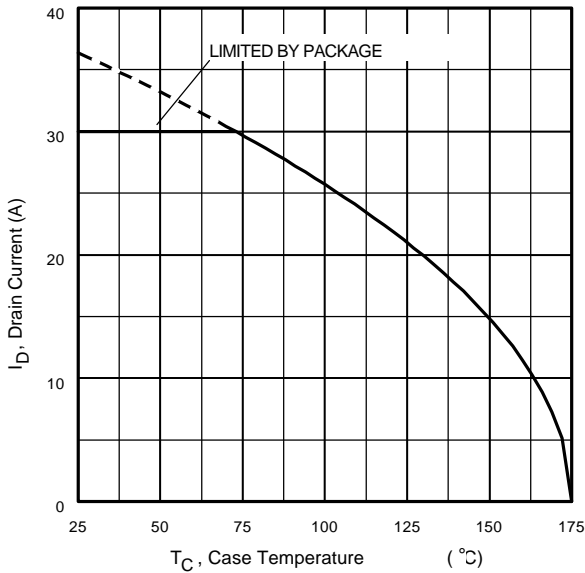

Fig 9. Maximum Drain Current Vs. Case Temperature

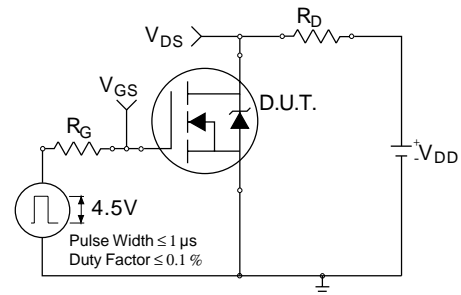

Fig 10a. Switching Time Test Circuit

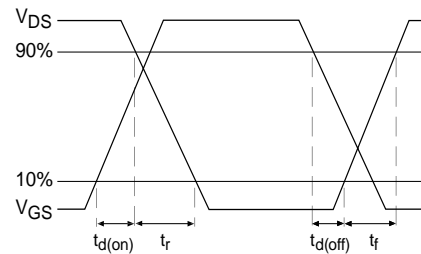

Fig 10b. Switching Time Waveforms

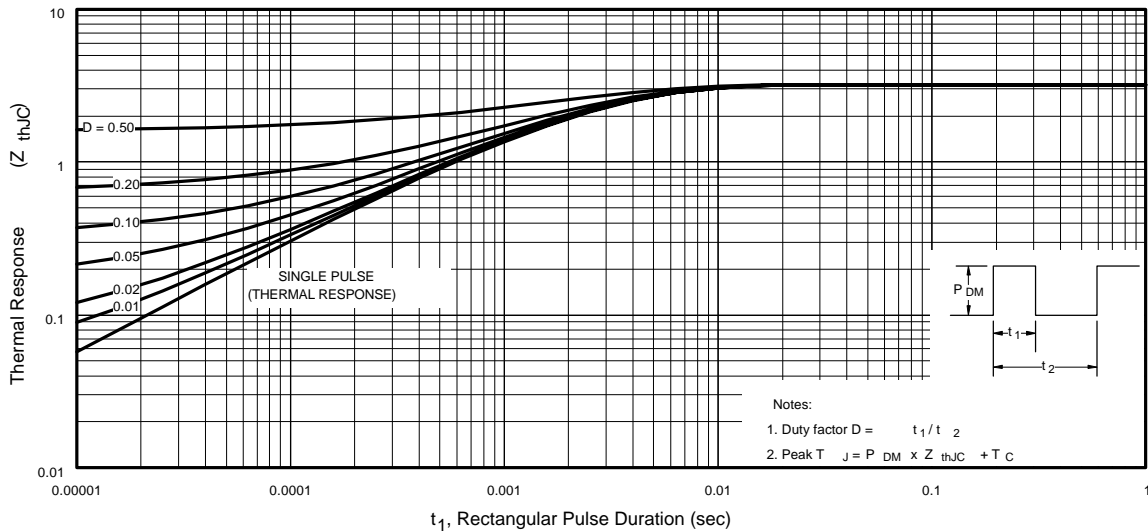

Fig 11. Maximum Effective Transient Thermal Impedance, Junction-to-Case

IRLR3714/IRLU3714

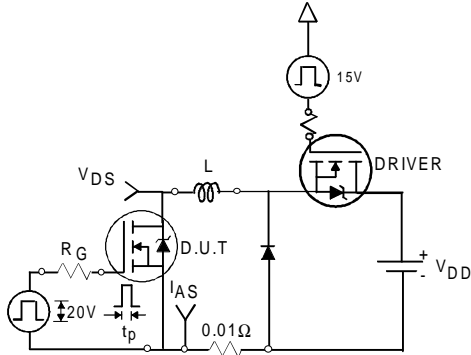

Fig 12a. Unclamped Inductive Test Circuit

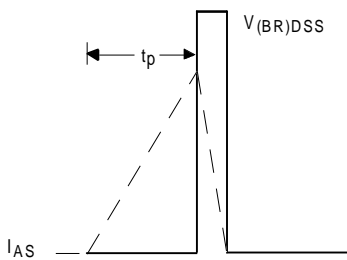

Fig 12b. Unclamped Inductive Waveforms

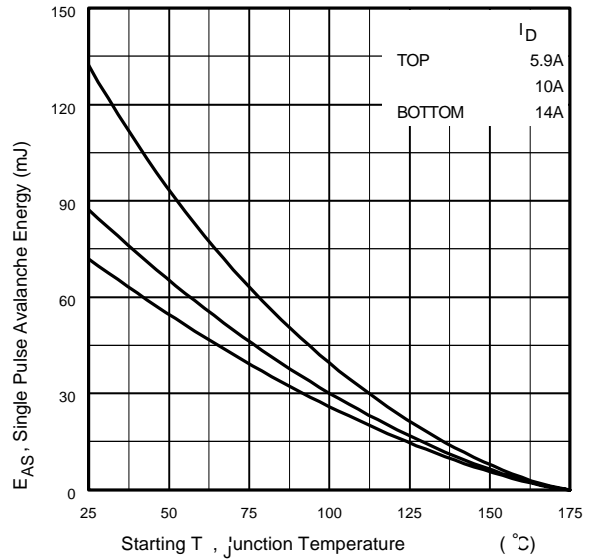

Fig 12c. Maximum Avalanche Energy Vs. Drain Current

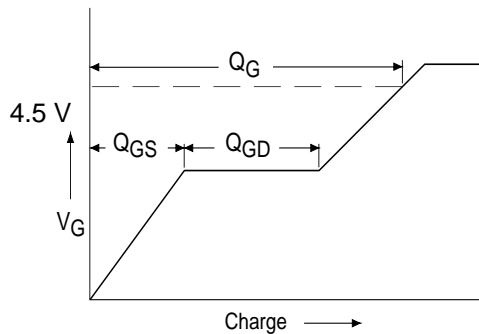

Fig 13a. Basic Gate Charge Waveform

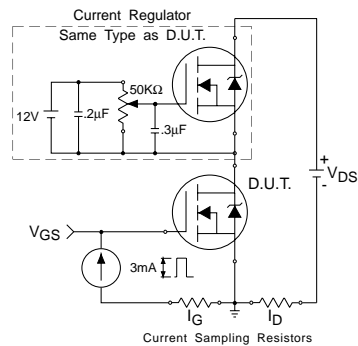
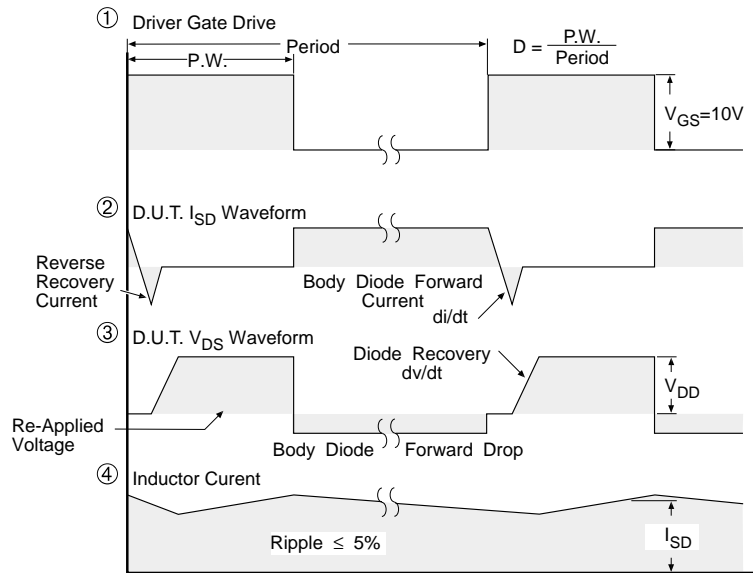
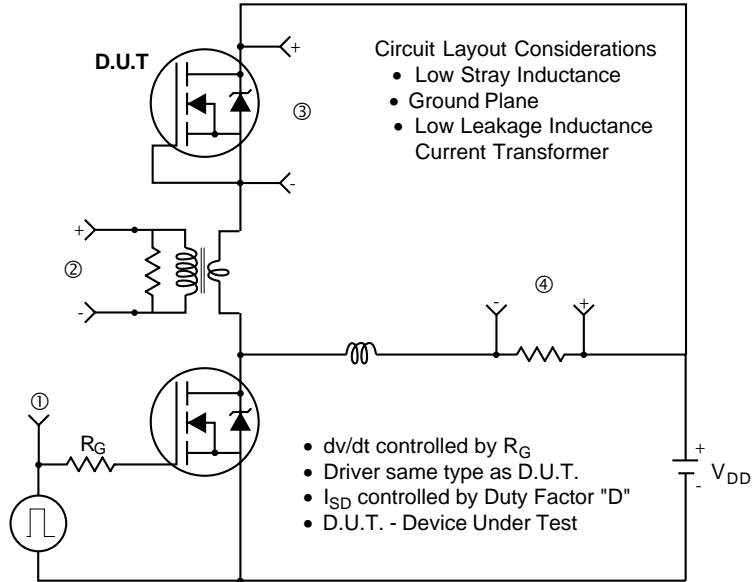

Fig 13b. Gate Charge Test Circuit

Peak Diode Recovery dv/dt Test Circuit



* $V_{GS} = 5V$ for Logic Level Devices

Fig 14. For N-Channel HEXFET[®] Power MOSFETs

I-Pak (TO-251AA) Package Outline

Dimensions are shown in millimeters (inches)

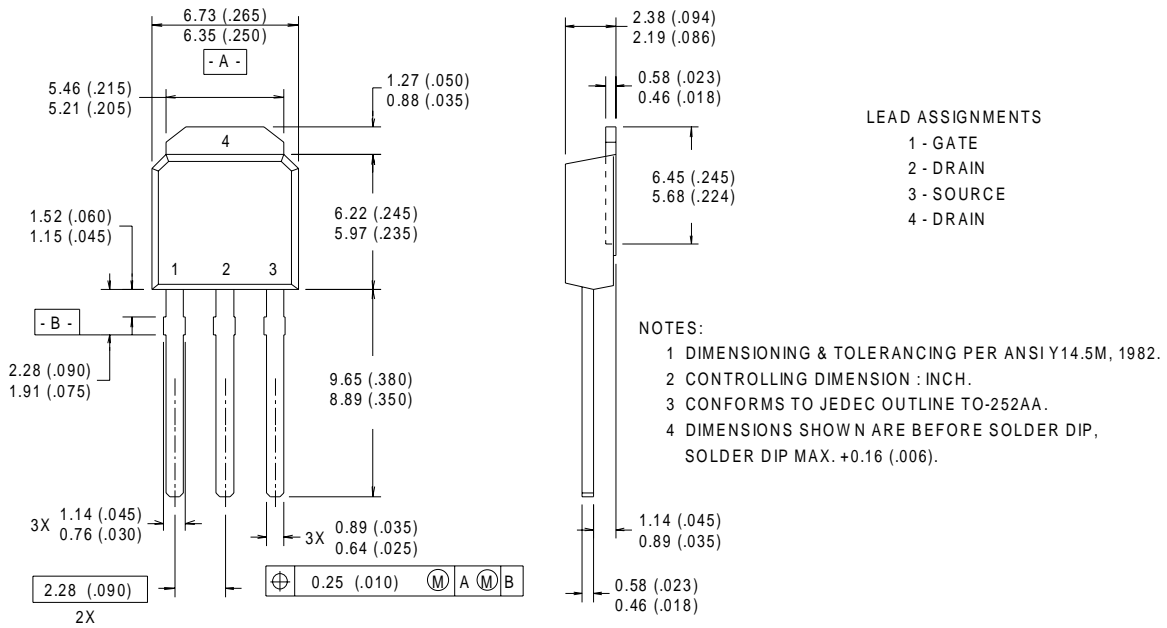

I-Pak (TO-251AA) Part Marking Information

EXAMPLE: THIS IS AN IRFU120
 LOT CODE 1789
 ASSEMBLED ON WW 19, 1997
 IN THE ASSEMBLY LINE "C"

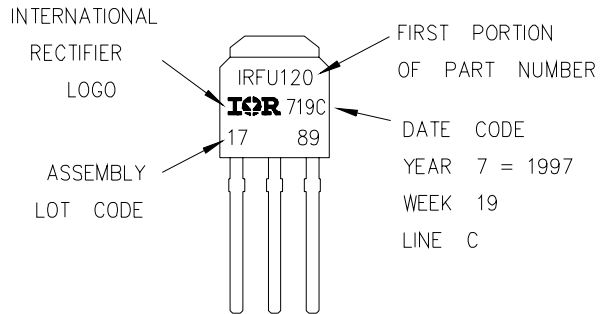

IRLR3714/IRLU3714

International
IR Rectifier

D-Pak (TO-252AA) Tape & Reel Information

Dimensions are shown in millimeters (inches)

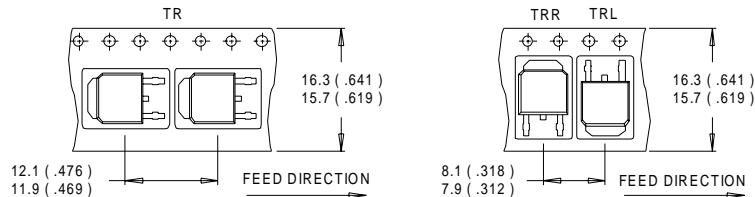

- NOTES :
1. CONTROLLING DIMENSION : MILLIMETER.
 2. ALL DIMENSIONS ARE SHOWN IN MILLIMETERS (INCHES).
 3. OUTLINE CONFORMS TO EIA-481 & EIA-541.

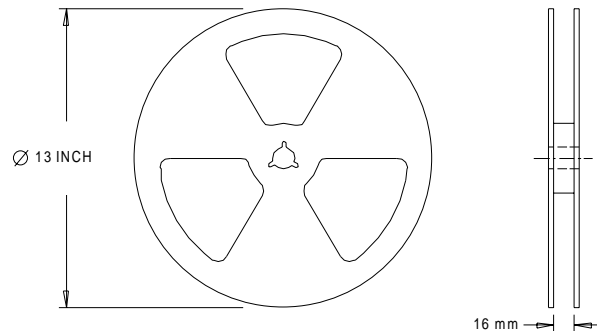

- NOTES :
1. OUTLINE CONFORMS TO EIA-481.

Notes:

- ① Repetitive rating; pulse width limited by max. junction temperature.
- ② Starting $T_J = 25^\circ\text{C}$, $L = 0.69 \text{ mH}$
 $R_G = 25\Omega$, $I_{AS} = 14\text{A}$.
- ③ Pulse width $\leq 400\mu\text{s}$; duty cycle $\leq 2\%$.
- ④ When mounted on 1" square PCB (FR-4 or G-10 Material). For recommended footprint and soldering techniques refer to application note #AN-994.
- ⑤ Calculated continuous current based on maximum allowable junction temperature; Package limitation current is 30A

Data and specifications subject to change without notice.
These products have been designed and qualified for the Industrial market.
Qualification Standards can be found on IR's Web site.

International
IR Rectifier

IR WORLD HEADQUARTERS: 233 Kansas St., El Segundo, California 90245, USA Tel: (310) 252-7105
TAC Fax: (310) 252-7903

Visit us at www.irf.com for sales contact information.06/01

www.irf.com

Note: For the most current drawings please refer to the IR website at:
<http://www.irf.com/package/>