

Temperature Controller E5CS-X

1/16 DIN Sized Controller Offers Selectable Control, Alarm Modes

- Accurate to $\pm 0.5\%$ of full scale.
- Multiple temperature scale ranges allow flexibility to match application.
- Field-selectable temperature ranges in $^{\circ}\text{F}$ and $^{\circ}\text{C}$.
- Selectable ON/OFF and PID control with auto-tuning of proportional band.
- 8-function alarm, standard.
- Tamper-proof setting, faulty sensor compensation and controller diagnostics.
- Easy-to-read 11 mm high LED display.
- Nonvolatile memory backup.
- 3-year warranty.



Ordering Information

Temperature Controllers

Stock Note: Shaded models are normally stocked.

Item		Model		
Sensor input type		Thermocouple (Types J and K)	Platinum RTD (Pt: 100 Ω , DIN and JIS standards)	Interchangeable thermistor (THE types)
Output	Contact	E5CS-R1KJX-F	E5CS-R1PJX-F	E5CS-R1GX-F
	Voltage	E5CS-Q1KJX-F	E5CS-Q1PJX-F	E5CS-Q1GX-F

Note: Items in the following table are sold in Canada only.

Item		Model		
Sensor input type		Thermocouple (Types J and K)	Platinum RTD (Pt: 100 Ω , DIN and JIS standards)	Interchangeable thermistor (THE types)
Output	Contact	E5CS-R1KJX	E5CS-R1PJX	E5CS-R1GX
	Voltage	E5CS-Q1KJX	E5CS-Q1PJX	E5CS-Q1GX

Accessories (Order Separately)

Stock Note: Shaded models are normally stocked.

Description		Model
Protective cover	Hard plastic; protects front panel against dust, dirt and water drops	Y92A-48
Panel mounting adapter	Replacement for one supplied with each unit	Y92F-30

Specifications

Model		E5CS-□1KJX	E5CS-□1PX	E5CS-□1GX
Sensor input type		Thermocouple Type J (IC) and Type K (CA)	Platinum RTD (Pt: 100Ω) DIN or JIS standard	Thermistor (interchangeable type)
Supply voltage		100 to 240 VAC, 50/60 Hz; operates on 85 to 110% of rated voltage		
Power consumption		Approx. 7 VA		
Control output	Contact	Type	SPDT relay	
		Max. load	3 A, 250 VAC (resistive load)	
	Voltage	Logic load	12 VDC, 20 mA with short-circuit protection	
	Hysteresis		0.2% of full scale during ON/OFF control action	
	Response time	Output	2 seconds for output to change	
		Display	2 seconds for displayed indication to change	
	Service life	Mechanical	10 million operation minimum with contact output	
Electrical		100,000 operations minimum with contact output		
Alarm output		Type	SPST-NO relay	
		Max. load	1 A, 250 VAC (resistive load)	
		Setting range	Absolute value alarm: Same as control output setting range Others: 0 to full scale	
Setting accuracy		Set value coincides with indicated value, so no relative error exists		
Indication accuracy		±0.5% of full scale, ±1 digit max.		
Display range		-999 to 999 (limited to input type)		
Control modes	Type	ON/OFF and PID with automatic tuning of proportional band, switch selectable		
	Proportional band	3% to 20% (in PID mode) automatically adjusted according to the rise time of the controlled system		
	Reset time	4 minutes (in PID mode)		
	Rate time	0.4 minutes (in PID mode)		
	Proportional period	2 or 20 seconds, switch selectable		
	Sampling period	500 ms		
Materials		Plastic case		
Mounting		Fits 1/16 DIN panel cutout; includes panel mounting adapter		
Connections		Screw terminals		
Weight		170 g (6 oz.) without mounting adapter		
Enclosure ratings	Front panel	IP50, NEMA 4 with optional Y92A-48N waterproof cover		
	Rear panel	IP30		
	Terminals	IP00		
Approvals	UL	Recognized, File Number E68481		
	CSA	Certified, File Number LR59623		
	CE	Conforms to EN61010-1		
Ambient temperature	Operating	-10°C to 55°C (14°F to 131°F)		
	Storage	-25°C to 65°C (-13°F to 149°F)		
Humidity		35 to 85% RH		
Insulation resistance		20 MΩ minimum at 500 VDC		
Dielectric strength		2,000 VAC, 50/60 Hz for 1 minute between current-carrying terminals of different polarity		
Vibration	Mechanical durability	10 to 55 Hz, 0.75 mm (0.03 in) double amplitude in X, Y, and Z directions for 2 hours each		
	Malfunction durability	2 to 55 Hz, 2 G in X, Y, and Z directions for 10 minutes each		
Shock	Mechanical durability	30 m/s ² , in 6 directions, 3 times each		
	Malfunction durability	100 m/s ² , in 6 directions, 3 times each		

Temperature Ranges

Thermocouple Input Type

Input type	Type K						Type J					
Temperature range	0 to 200	0 to 300	0 to 400	0 to 500	0 to 600	0 to 999	0 to 999	0 to 200	0 to 300	0 to 400	0 to 500	
Scale indication	°C	°C	°C/°F	°C/°F	°C/°F	°C/°F	°F	°C	°C	°C/°F	°C/°F	
Unit of measure	1° C or F											

Platinum RTD Input Type

Temperature range	-50 to 50	0.0 to 50.0	-20 to 80	0.0 to 99.9	0 to 200	0 to 300	0 to 400	0 to 600	0 to 800
Scale indication	°C	°C	°C	°C/°F	°C/°F	°C	°C/°F	°F	°F
Unit of measure	1° C or F	0.1° C or F	1° C or F	0.1° C or F	1° C or F				

Thermistor Input Type

Temp. range	-50 to 50	0 to 100	50 to 150	100 to 200	150 to 300	-50 to 100	0 to 200	100 to 300	200 to 400	300 to 600	
Scale indication	°C						°F				
Unit of measure	1° C or F										

Nomenclature

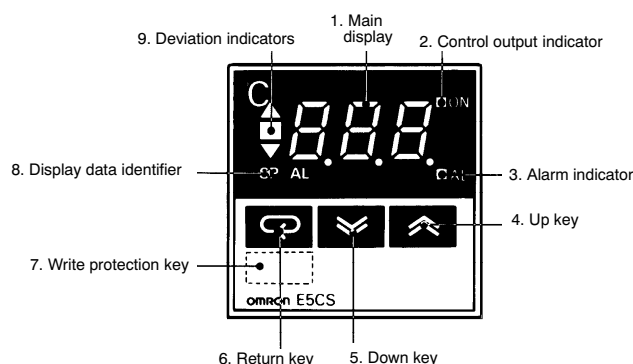

Key	Description	Key	Description
1	Main display sequentially displays the present temperature, set temperature, and an alarm value each time the return key is pressed.	7	The hidden write protection key provides protection against unauthorized setting of temperature and is used in conjunction with the internal "protection" switch. If the internal protection switch is set to ON, then to obtain Up and Down operation, the hidden key must be pressed simultaneously with the Up and Down keys. If the internal protection switch is set to OFF, changes can be made simply by pressing the Up and Down keys.
2	Control output indicator lights when the output is ON.		
3	Alarm indicator lights when the alarm output is ON.		
4	Up key increases the set temperature or alarm value when pressed. Increases the value quickly when held down.	8	Display data identifier lights SP when the set temperature is displayed on the main display and AL when an alarm value is displayed.
5	Down key decreases the set temperature or alarm value when pressed. Decreases the value quickly when held down.		
6	Return key changes the value displayed on the main display each time pressed.	9	Red deviation indicators light up an arrow when the present temperature is higher than the set temperature and light a down arrow when the present value is lower than the set temperature. The green block indicates the temperature deviation is within $\pm 1\%$ of the full scale.

Dimensions

Unit: mm (inch)

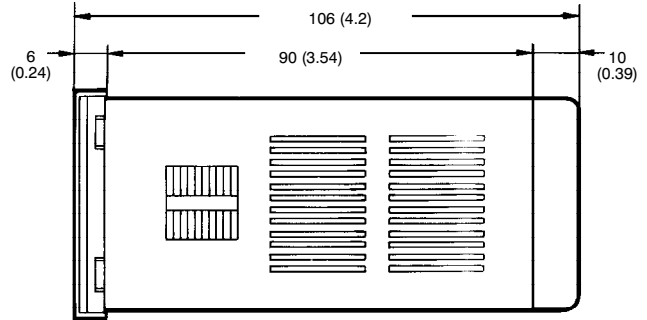
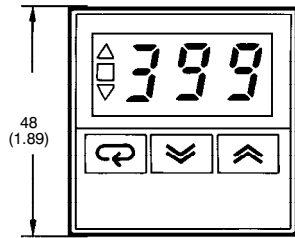
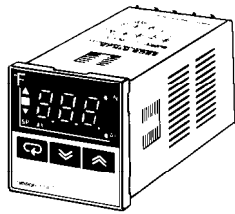

Panel Cutout

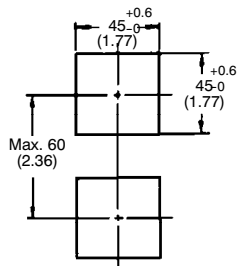

Side-by-side Mounting of Several Temperature Controllers

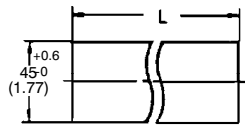

$$L = 48 \times \text{number of units} - 2.5$$

$$(1.89 \times \text{number of units} - 0.1)$$

Controllers	2	3	4	5	6
L	93.5 ⁺¹ ₋₀ (3.68)	141.5 ⁺¹ ₋₀ (5.57)	189.5 ⁺¹ ₋₀ (7.46)	237.5 ⁺¹ ₋₀ (9.35)	285.5 ⁺¹ ₋₀ (11.24)

- Note: 1. Recommended panel thickness is 1 to 8 mm (0.04 to 0.31 in).
 2. Because mounting brackets are attached to the top and bottom of a temperature controller, tight side-by-side mounting is possible.

Connections

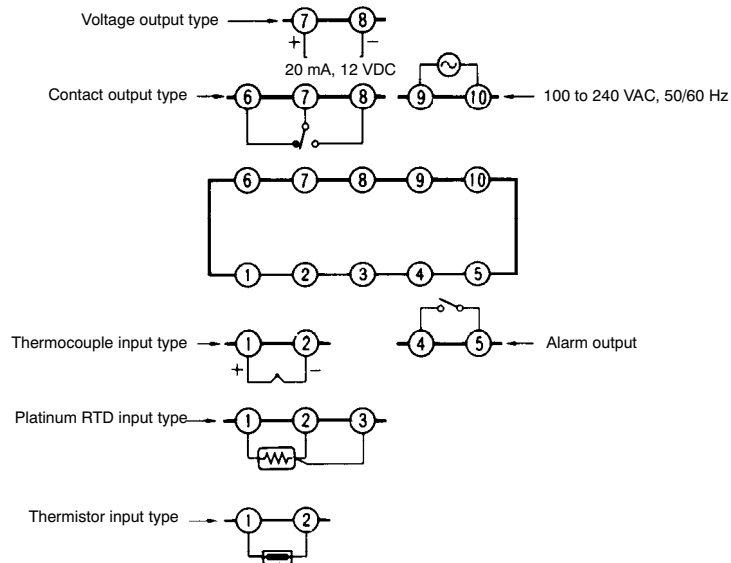

Operation

Settings Before Applying Power

Note: Always turn off the power supply to the temperature controller before changing any switch settings.

Before applying power to the temperature controller, set the following selector switches to specify the temperature range, functions and alarm mode.

Access to Internal Switches and Selectors

Push the tab on the underside of the front panel as you draw out the internal mechanism from the housing. The temperature range selector, and the alarm mode selector must all be set. A protection switch can also be set to protect settings. The following diagrams show the locations of these switches on the internal mechanism.

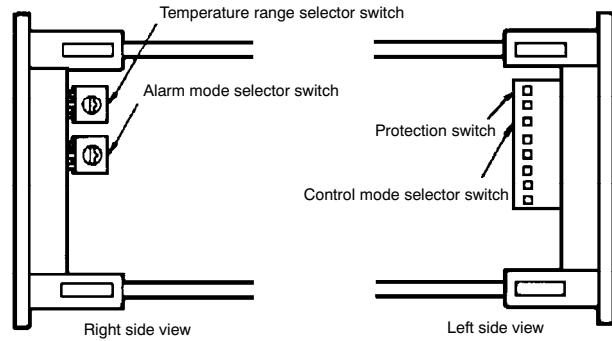
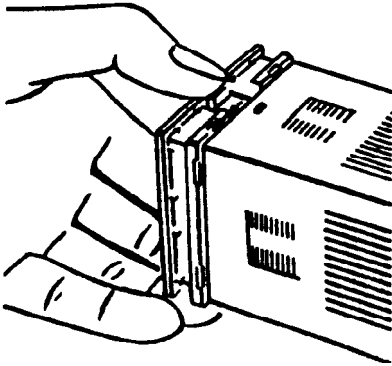

Select the desired temperature range by using the temperature range selector switch (rotary DIP type). The other rotary DIP switch is used to select one of eight alarm functions. Be sure the set temperature and alarm values are within the new range. Otherwise, the temperature controller automatically shifts these values to the maximum or minimum of the newly-set temperature range.

The protection switch may be used in conjunction with the front panel "hidden key" to prevent unauthorized changes to temperature settings. The switch is ON when it is pushed inwards in the direction of the white arrow.

The function selector switch is a 8-pin in-line DIP switch on the other side of the internal mechanism. Use it to select ON/OFF or PID control action, proportional period, control output, input shift function, temperature sensor input standard and scale indication for dual-scale temperature ranges.

When All Functions Have Been Selected

To Set Temperature

Press the return key until the SP indicator lights. Then set the desired temperature value by using the Up and Down keys.

To Set Alarm Value

Press the return key until the AL indicator lights. Then set the desired alarm value in units of °F or °C. If the present temperature exceeds the set alarm value, the alarm output will be issued.

Neither the set alarm value is displayed nor the AL indicator lights with the integral alarm mode setting switch set to 0 or 9. Be sure to check the alarm mode setting switch, located inside the housing, for proper setting.

In Case of Sensor Failure

The error message "FFF" or "---" will appear on the main display if the temperature sensor short-circuits or breaks.

Precautions





The E5CS-X temperature controller has self-diagnostic functions that display the following error messages to simplify troubleshooting.

Message	Cause	Control output
FFF	(1) Temperature has risen beyond temperature scale range (2) Thermistor has been short-circuited	OFF during heating (reverse) operation ON during cooling (normal) operation
---	(1) Temperature has fallen below temperature scale range (2) Thermistor has broken	ON during heating (reverse) operation OFF during cooling (normal) operation
FFF (blinks)*	(1) Failure has occurred in thermocouple or platinum RTD (2) Temperature has risen much beyond scale range	OFF
--- (blinks)*	(1) Failure has occurred in platinum RTD (2) Polarities (positive and negative) of thermocouple are reversed (3) Temperature has fallen much below scale range	OFF
E11 or E33*	(1) Memory failure (E11) display (2) Analog-to-digital converter failure (E33) display Temperature controller must be repaired if recovery is not made by turning power off once and on again.	Both control outputs and the alarm output are OFF

Note: *Key operations are disabled.

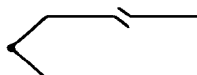
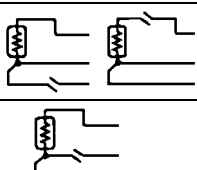
When the alarm outputs are used, an alarm output occurs when the “FFF” and “---” messages appear in the display. These displays indicate when the temperature has risen beyond or fallen below the temperature scale range.

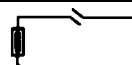
■ Sensor Failure Indication

Condition	Display	Control output
Thermocouple sensor		
Break in sensor 	FFF blinks	OFF
Short-circuit	Ambient temperature	OFF
Platinum RTD sensor		
Break in sensor 	FFF blinks	OFF
	--- blinks	OFF
	Disconnection of two or three wires FFF blinks	OFF
Short-circuit 	--- blinks	OFF
Thermistor sensor		
Break in sensor 	---	ON during heating (reverse) action OFF during cooling (normal) action
Short-circuit 	FFF	ON during heating (reverse) action OFF during cooling (normal) action

Note: The resistance of the platinum RTD is 100 Ω at 0°C and increases to 140 Ω at 100°C.

Installation

■ Mounting

All E5CS-X models conform to DIN 43700 standard. Recommended panel thickness is 1 to 4 mm (0.04 to 0.16 in).

Insert the temperature controller, back end first, into the panel cutout. Mount the adapter (Y92F-30) supplied with each unit by pushing it forward from the back of the temperature controller. Push the adapter as close as possible to the front panel of the temperature controller to eliminate the gap between them. Then, secure the adapter with screws as shown.

Removal

Loosen the screws on the adapter and push the hook open to remove the adapter.

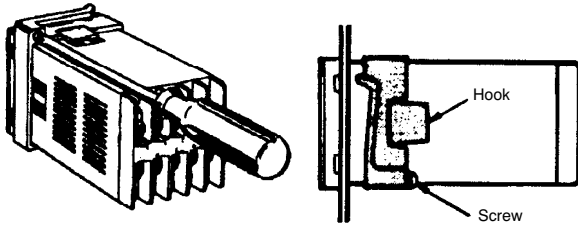

■ Connections

Connection Examples

Use M3.5 solderless terminals with the temperature controller's M3.5 self-rising pressure plate screws.

For solder-dipped leads, strip the lead wire 6 to 12 mm (0.24 to 0.47 in) and carefully insert the wire tip. Do not tighten the terminal screw with excessive force.

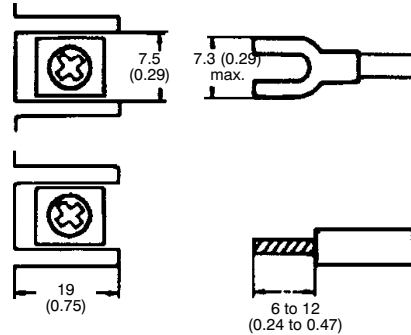

Precautions

■ Environment

Do not install the temperature controller in a location where there is a lot of dust or corrosive gases. Also avoid a location where the temperature controller is subjected to heavy vibration, shock, splashes of water or oil, and high temperatures.

Separate the temperature controller from equipment that generates strong, high-frequency electrical noise such as welding equipment.

Sensor Input Connections

The lead wires connecting the platinum RTD to the temperature controller must be separated from the power lines and the load lines, wherever possible, to prevent them from being inducted by electrical noise.

Use the specified compensating conductors for the thermocouple input type temperature controllers.

Use lead wires having a small resistance for the platinum RTD type temperature controllers.

Sequence Circuit

Several seconds are required until the relay is turned ON after the power has been applied to the temperature controller. Be sure to take this time lag into consideration when designing a sequence circuit which incorporates this temperature controller.

■ Recalibration

The E5CS-X temperature controller can be recalibrated by a factory-authorized repair service. Contact Omron for the location near you.

Unauthorized recalibration of the controller will void the warranty and may lead to erratic operation.

Certain Terms and Conditions of Sale

1. **Offer; Acceptance.** These terms and conditions (these "Terms") are deemed part of all catalogs, manuals or other documents, whether electronic or in writing, relating to the sale of goods or services (collectively, the "Goods") by Omron Electronics LLC and its subsidiary companies ("Seller"). Seller hereby objects to any terms or conditions proposed in Buyer's purchase order or other documents which are inconsistent with, or in addition to, these Terms. Please contact your Omron representative to confirm any additional terms for sales from your Omron company.
2. **Prices.** All prices stated are current, subject to change without notice by Seller. Buyer agrees to pay the price in effect at time of shipment.
3. **Discounts.** Cash discounts, if any, will apply only on the net amount of invoices sent to Buyer after deducting transportation charges, taxes and duties, and will be allowed only if (i) the invoice is paid according to Seller's payment terms and (ii) Buyer has no past due amounts owing to Seller.
4. **Orders.** Seller will accept no order less than \$200 net billing.
5. **Governmental Approvals.** Buyer shall be responsible for, and shall bear all costs involved in, obtaining any government approvals required for the importation or sale of the Goods.
6. **Taxes.** All taxes, duties and other governmental charges (other than general real property and income taxes), including any interest or penalties thereon, imposed directly or indirectly on Seller or required to be collected directly or indirectly by Seller for the manufacture, production, sale, delivery, importation, consumption or use of the Goods sold hereunder (including customs duties and sales, excise, use, turnover and license taxes) shall be charged to and remitted by Buyer to Seller.
7. **Financial.** If the financial position of Buyer at any time becomes unsatisfactory to Seller, Seller reserves the right to stop shipments or require satisfactory security or payment in advance. If Buyer fails to make payment or otherwise comply with these Terms or any related agreement, Seller may (without liability and in addition to other remedies) cancel any unshipped portion of Goods sold hereunder and stop any Goods in transit until Buyer pays all amounts, including amounts payable hereunder, whether or not then due, which are owing to it by Buyer. Buyer shall in any event remain liable for all unpaid accounts.
8. **Cancellation; Etc.** Orders are not subject to rescheduling or cancellation unless Buyer indemnifies Seller fully against all costs or expenses arising in connection therewith.
9. **Force Majeure.** Seller shall not be liable for any delay or failure in delivery resulting from causes beyond its control, including earthquakes, fires, floods, strikes or other labor disputes, shortage of labor or materials, accidents to machinery, acts of sabotage, riots, delay in or lack of transportation or the requirements of any government authority.
10. **Shipping; Delivery.** Unless otherwise expressly agreed in writing by Seller:
 - a. Shipments shall be by a carrier selected by Seller;
 - b. Such carrier shall act as the agent of Buyer and delivery to such carrier shall constitute delivery to Buyer;
 - c. All sales and shipments of Goods shall be FOB shipping point (unless otherwise stated in writing by Seller), at which point title to and all risk of loss of the Goods shall pass from Seller to Buyer, provided that Seller shall retain a security interest in the Goods until the full purchase price is paid by Buyer;
 - d. Delivery and shipping dates are estimates only.
 - e. Seller will package Goods as it deems proper for protection against normal handling and extra charges apply to special conditions.
11. **Claims.** Any claim by Buyer against Seller for shortage or damage to the Goods occurring before delivery to the carrier must be presented in writing to Seller within 30 days of receipt of shipment and include the original transportation bill signed by the carrier noting that the carrier received the Goods from Seller in the condition claimed.
12. **Warranties.** (a) **Exclusive Warranty.** Seller's exclusive warranty is that the Goods will be free from defects in materials and workmanship for a period of twelve months from the date of sale by Seller (or such other period expressed in writing by Seller). Seller disclaims all other warranties, express or implied. (b) **Limitations.** SELLER MAKES NO WARRANTY OR REPRESENTATION, EXPRESS OR IMPLIED, ABOUT NON-INFRINGEMENT, MERCHANTABILITY OR FITNESS FOR A PARTICULAR PURPOSE OF THE GOODS. BUYER ACKNOWLEDGES THAT IT ALONE HAS DETERMINED THAT THE GOODS WILL SUITABLY MEET THE REQUIREMENTS OF THEIR INTENDED USE. Seller further disclaims all warranties and responsibility of any type for claims or expenses based on infringement by the Goods or otherwise of any intellectual property right. (c) **Buyer Remedy.** Seller's sole obligation hereunder shall be to replace (in the form originally shipped with Buyer responsible for labor charges for removal or replacement thereof) the non-complying Good or, at Seller's election, to repay or credit Buyer an amount equal to the purchase price of the Good; provided that in no event shall Seller be responsible for warranty, repair, indemnity or any other claims or expenses regarding the Goods unless Seller's analysis confirms that the Goods were properly handled, stored, installed and maintained and not subject to contamination, abuse, misuse or inappropriate modification. Return of any goods by Buyer must be approved in writing by Seller before shipment. Seller shall not be liable for the suitability or unsuitability or the results from the use of Goods in combination with any electrical or electronic components, circuits, system assemblies or any other materials or substances or environments. Any advice, recommendations or information given orally or in writing, are not to be construed as an amendment or addition to the above warranty.
13. **Damage Limits; Etc.** SELLER SHALL NOT BE LIABLE FOR SPECIAL, INDIRECT OR CONSEQUENTIAL DAMAGES, LOSS OF PROFITS OR PRODUCTION OR COMMERCIAL LOSS IN ANY WAY CONNECTED WITH THE GOODS, WHETHER SUCH CLAIM IS BASED IN CONTRACT, WARRANTY, NEGLIGENCE OR STRICT LIABILITY. Further, in no event shall liability of Seller exceed the individual price of the Good on which liability is asserted.
14. **Indemnities.** Buyer shall indemnify and hold harmless Seller, its affiliates and its employees from and against all liabilities, losses, claims, costs and expenses (including attorney's fees and expenses) related to any claim, investigation, litigation or proceeding (whether or not Seller is a party) which arises or is alleged to arise from Buyer's acts or omissions under these Terms or in any way with respect to the Goods. Without limiting the foregoing, Buyer (at its own expense) shall indemnify and hold harmless Seller and defend or settle any action brought against Seller to the extent that it is based on a claim that any Good made to Buyer specifications infringed intellectual property rights of another party.
15. **Property; Confidentiality.** The intellectual property embodied in the Goods is the exclusive property of Seller and its affiliates and Buyer shall not attempt to duplicate it in any way without the written permission of Seller. Notwithstanding any charges to Buyer for engineering or tooling, all engineering and tooling shall remain the exclusive property of Seller. All information and materials supplied by Seller to Buyer relating to the Goods are confidential and proprietary, and Buyer shall limit distribution thereof to its trusted employees and strictly prevent disclosure to any third party.
16. **Miscellaneous.** (a) **Waiver.** No failure or delay by Seller in exercising any right and no course of dealing between Buyer and Seller shall operate as a waiver of rights by Seller. (b) **Assignment.** Buyer may not assign its rights hereunder without Seller's written consent. (c) **Amendment.** These Terms constitute the entire agreement between Buyer and Seller relating to the Goods, and no provision may be changed or waived unless in writing signed by the parties. (d) **Severability.** If any provision hereof is rendered ineffective or invalid, such provision shall not invalidate any other provision. (e) **Setoff.** Buyer shall have no right to set off any amounts against the amount owing in respect of this invoice. (f) As used herein, "including" means "including without limitation".

Certain Precautions on Specifications and Use

1. **Suitability of Use.** Seller shall not be responsible for conformity with any standards, codes or regulations which apply to the combination of the Good in the Buyer's application or use of the Good. At Buyer's request, Seller will provide applicable third party certification documents identifying ratings and limitations of use which apply to the Good. This information by itself is not sufficient for a complete determination of the suitability of the Good in combination with the end product, machine, system, or other application or use. The following are some examples of applications for which particular attention must be given. This is not intended to be an exhaustive list of all possible uses of this Good, nor is it intended to imply that the uses listed may be suitable for this Good:
 - (i) Outdoor use, uses involving potential chemical contamination or electrical interference, or conditions or uses not described in this document.
 - (ii) Energy control systems, combustion systems, railroad systems, aviation systems, medical equipment, amusement machines, vehicles, safety equipment, and installations subject to separate industry or government regulations.
 - (iii) Systems, machines and equipment that could present a risk to life or property. Please know and observe all prohibitions of use applicable to this Good.
2. **Programmable Products.** Seller shall not be responsible for the user's programming of a programmable Good, or any consequence thereof.
3. **Performance Data.** Performance data given in this catalog is provided as a guide for the user in determining suitability and does not constitute a warranty. It may represent the result of Seller's test conditions, and the user must correlate it to actual application requirements. Actual performance is subject to the Seller's Warranty and Limitations of Liability.
4. **Change in Specifications.** Product specifications and accessories may be changed at any time based on improvements and other reasons. It is our practice to change part numbers when published ratings or features are changed, or when significant construction changes are made. However, some specifications of the Good may be changed without any notice. When in doubt, special part numbers may be assigned to fix or establish key specifications for your application. Please consult with your Seller's representative at any time to confirm actual specifications of purchased Good.
5. **Errors and Omissions.** The information in this catalog has been carefully checked and is believed to be accurate; however, no responsibility is assumed for clerical, typographical or proofreading errors, or omissions.

NEVER USE THE PRODUCT FOR AN APPLICATION INVOLVING SERIOUS RISK TO LIFE OR PROPERTY WITHOUT ENSURING THAT THE SYSTEM AS A WHOLE HAS BEEN DESIGNED TO ADDRESS THE RISKS, AND THAT THE SELLER'S PRODUCT IS PROPERLY RATED AND INSTALLED FOR THE INTENDED USE WITHIN THE OVERALL EQUIPMENT OR SYSTEM.

Complete “Terms and Conditions of Sale” for product purchase and use are on Omron’s website at www.omron.com/oei – under the “About Us” tab, in the Legal Matters section.

ALL DIMENSIONS SHOWN ARE IN MILLIMETERS.

To convert millimeters into inches, multiply by 0.03937. To convert grams into ounces, multiply by 0.03527.

OMRON[®]**OMRON ELECTRONICS LLC**

One Commerce Drive
Schaumburg, IL 60173

847-843-7900

For US technical support or other inquiries:

800-556-6766**OMRON CANADA, INC.**

885 Milner Avenue
Toronto, Ontario M1B 5V8

416-286-6465**OMRON ON-LINE**

Global - <http://www.omron.com>
USA - <http://www.omron.com/oei>
Canada - <http://www.omron.ca>