Backlight/Flash LED Driver and Triple LDO Lighting Management Unit

General Description

The AAT2866 is a highly integrated charge pump-based lighting management unit (LMU) offering eight LED channels with three linear regulators optimized for single-cell lithium-ion/polymer systems. The charge pump provides power for all LED outputs and multiple backlight and flash LED configurations are available. The backlight LED channel outputs are programmable up to 31mA and the total flash LED output current can be programmed up to 600mA.

Skyworks' AS²Cwire™ single-wire interface is used to enable, disable, and set the current to one of 32 levels for the backlight and one of 16 levels for the flash. A separate flash enable and programmable safety timer are included for easy flash control. Backlight current matching is better than 3% for uniform display brightness, and flash current matching is better than 5% for uniform power dissipation. As an alternative, the main backlight LED's output current can be controlled via pulse width modulation (PWM).

The AAT2866 also offers three high-performance low-noise MicroPower™ low dropout (LDO) linear regulators. The regulators output voltages are set through the AS²Cwire serial interface. Each LDO can supply up to 300mA load current and ground-pin current is only 80µA making the AAT2866 ideal for battery-operated applications.

The AAT2866 is available in a Pb-free, space-saving TQFN34-24 package and operates over the -40°C to +85°C ambient temperature range.

Features

- Input Voltage Range: 2.7V to 5.5V
- AS²Cwire Serial Interface
- Tri-Mode Charge Pump
 - Drives up to Eight LEDs
- Programmable Backlight Current by:
 - AS²Cwire Interface
 - 31mA Maximum Current per Channel
 - 32 Linear Current Settings
 - Independent Main/Sub Settings
 - PWM Control
 - All Channels BL1-BL6 (default)
 - Main Backlight BL1-BL4 (optional)
 - All Channels BL1-BL7 (AAT2866-3)
 - 60Hz to 100kHz
 - Programmable Flash Current
 - 600mA Total Flash Current
 - 16 Linear Current Settings
 - 2 Channel Configuration
- 1MHz Switching Frequency
- Automatic Soft Start
- Three Linear Regulators
 - 300mA Output Current
 - 150mV Dropout
 - Programmable Control from 1.2V to 3.3V
 - Output Auto-Discharge for Fast Shutdown
- Built-In Thermal Protection
- Automatic Soft Start
- -40°C to +85°C Temperature Range
- TQFN34-24 Package

Applications

- Camera Enabled Mobile Devices
- Digital Still Cameras
- Multimedia Mobile Phones

AAT2866

Backlight/Flash LED Driver and Triple LDO Lighting Management Unit

Typical Application

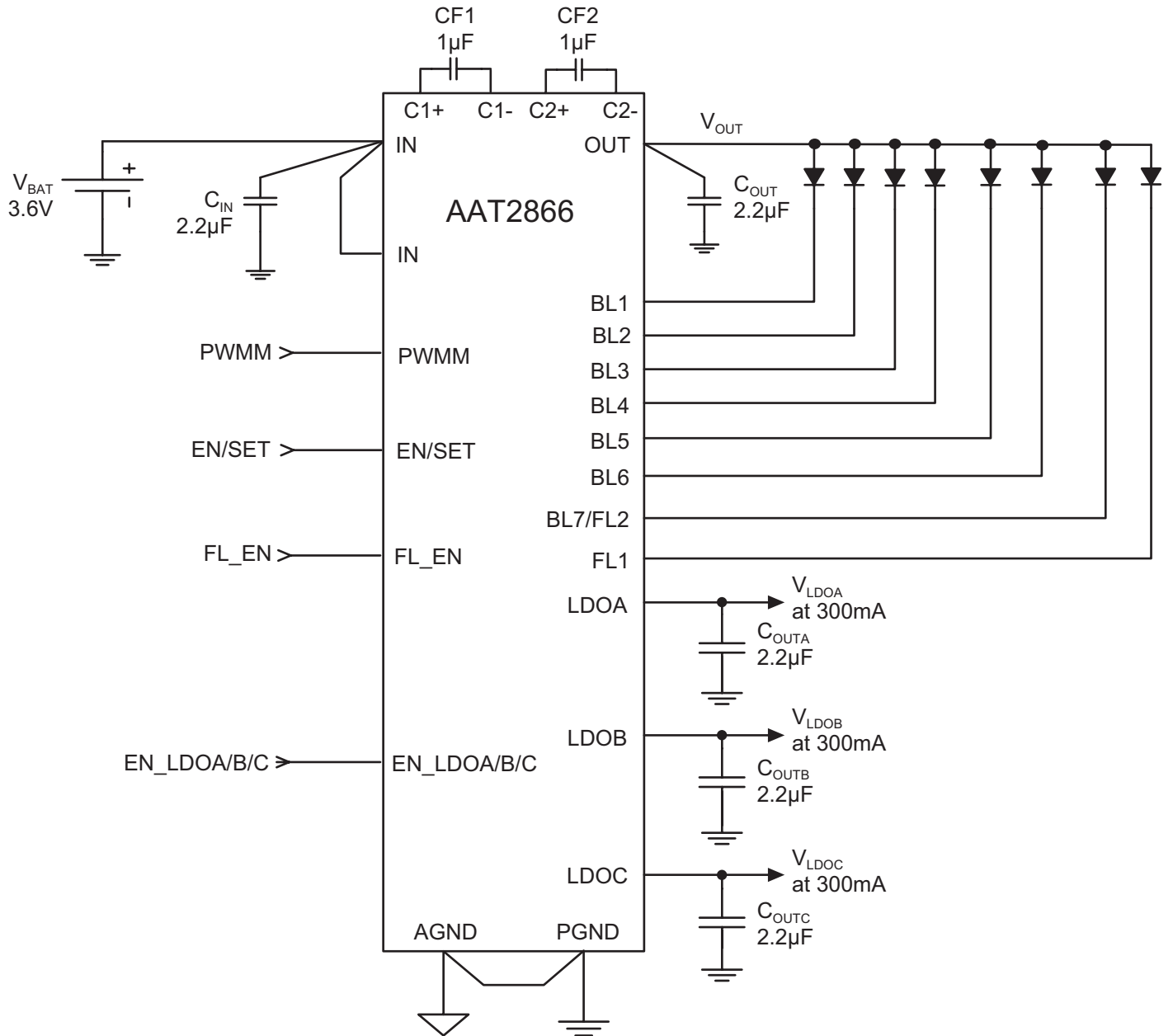

Backlight/Flash LED Driver and Triple LDO Lighting Management Unit**Pin Descriptions**

Pin #	Symbol	Function	Description
1	OUT	O	Charge-pump output. OUT is the output of the charge pump and supplies current to the backlight and flash LEDs. Connect the backlight and flash LED anodes to OUT. Bypass OUT to PGND with a 2.2 μ F or larger ceramic capacitor as close to the AAT2866 as possible.
2	C2+	I	Positive terminal of charge pump capacitor 2. Connect the 1 μ F charge pump capacitor 2 from C2+ to C2-.
3	EN/SET	I	AS ² Cwire serial input. EN/SET is the address and data input of the AS ² Cwire serial interface. AS ² Cwire is used to control backlight, flash and LDO functions.
4	FL_EN	I	Flash enable. FL_EN is the enable control for the Flash LEDs. For the FL_EN pin to enable the flash current the EN/SET pin must also be pulled high.
5	PWMM	I	PWM input pin. Apply a PWM signal of varying duty cycle to modulate the LED current on BL1, BL2, BL3, BL4, BL5 & BL6 (Default). PWM frequency can vary up to 100kHz. The LED current maximum will be set at the default setting if no programming is applied. If not used, connect PWMM to IN.
6	EN_LDOA/B/C	I	LDOA, LDOB and LDOC enable pin. EN_LDOA/B/C enables all LDO regulators A. The EN/SET pin must also be pulled high for the LDO regulators to be enabled. The EN_LDOA/B/C input can be overwritten via the AS ² Cwire interface to disable either LDOA or LDOB or LDOC.
7	AGND	GND	Analog ground. Connect AGND to PGND at a single point as close to the AAT2866 as possible.
8	LDOC	O	LDOC is the voltage output of LDOC. Bypass LDOC to AGND with a 2.2 μ F or greater capacitor as close to the AAT2866 as possible.
9	IN	I	Input power pin for all three LDOs. Connect Pin 11 to Pin 23 with as short a PCB trace as practical.
10	LDOB	O	LDOB is the voltage output of LDOB. Bypass LDOB to AGND with a 2.2 μ F or greater capacitor as close to the AAT2866 as possible.
11	LDOA	O	LDOA is the voltage output of LDOA. Bypass LDOA to AGND with a 2.2 μ F or larger ceramic capacitor as close to the AAT2866 as possible.
12	BL1	O	Backlight LED 1 current sink. BL1 controls the current through backlight LED 1. Connect the cathode of backlight LED 1 to BL1. If not used, connect BL1 to OUT.
13	BL2	O	Backlight LED 2 current sink. BL2 controls the current through backlight LED 2. Connect the cathode of backlight LED 2 to BL2. If not used, connect BL2 to OUT.
14	BL3	O	Backlight LED 3 current sink. BL3 controls the current through backlight LED 3. Connect the cathode of backlight LED 3 to BL3. If not used, connect BL3 to OUT.
15	BL4	O	Backlight LED 4 current sink. BL4 controls the current through backlight LED 4. Connect the cathode of backlight LED 4 to BL4. If not used, connect BL4 to OUT.
16	BL5	O	Backlight LED 5 current sink. BL5 controls the current through backlight LED 5. Connect the cathode of backlight LED 5 to BL5. If not used, connect BL5 to OUT.
17	BL6	O	Backlight LED 6 current sink. BL6 controls the current through backlight LED 6. Connect the cathode of backlight LED 6 to BL6. If not used, connect BL6 to OUT.
18	BL7/FL2	O	AAT2866: Flash LED 2 current sink. FL2 controls the current through Flash LED 2. Connect the cathode of Flash LED 2 to FL2. If not used, connect FL2 to OUT. AAT2866-3: Backlight LED 7 current sink. BL7 controls the current through backlight LED 7. Connect the cathode of backlight LED 7 to BL7. If not used, connect BL7 to OUT.
19	FL1	O	Flash LED 1 current sink. FL1 controls the current through Flash LED 1. Connect the cathode of Flash LED 1 to FL1. If not used, connect FL1 to OUT.
20	PGND	GND	Power ground. Connect PGND to AGND at a single point as close to the AAT2866 as possible.
21	C2-	I	Negative terminal of charge pump capacitor 2.
22	C1-	I	Negative terminal of charge pump capacitor 1.
23	IN	I	Power input. Connect IN to the input source voltage. Bypass IN to PGND with a 2.2 μ F or larger ceramic capacitor as close to the AAT2866 as possible.
24	C1+	I	Positive terminal of charge pump capacitor 1. Connect the 1 μ F charge pump capacitor 1 from C1+ to C1-.
EP		GND	Exposed paddle (bottom) Connect to PGND/AGND as close to the AAT2866 as possible.

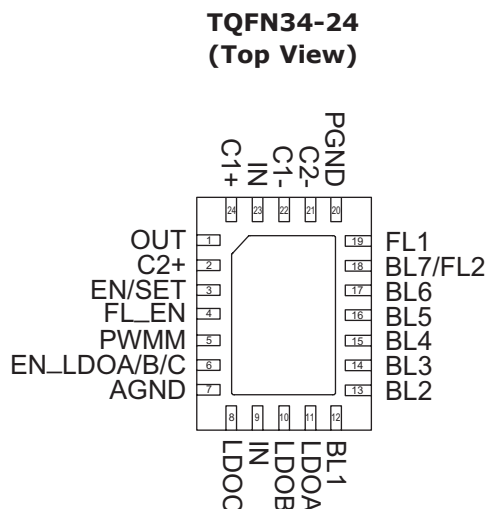
Backlight/Flash LED Driver and Triple LDO Lighting Management Unit**Pin Configuration****Part Number Description¹**

Part Number	Backlight LED Outputs		Flash LED Output
	Main	Sub	
AAT2866IMK-T1	6/4	0/2	2
AAT2866IMK-3-T1	5	2	1

Absolute Maximum Ratings²

$T_A = 25^\circ\text{C}$ unless otherwise noted.

Symbol	Description	Value	Units
	IN, OUT, BL1, BL2, BL3, BL4, BL5, BL6, FL1, BL7/FL2 Voltage to AGND	-0.3 to 6.0	V
	C1+, C2+ Voltage to AGND	-0.3 to $V_{OUT} + 0.3$	
	C1-, C2-, LDOA, LDOB, LDOC, EN/SET, FL_EN, EN_LDOA/B/C, PWMM Voltage to AGND	-0.3 to $V_{IN} + 0.3$	
	PGND Voltage to AGND	-0.3 to 0.3	

Thermal Information^{3, 4}

Symbol	Description	Value	Units
Θ_{JA}	Thermal Resistance	50	OC/W
P_D	Maximum Power Dissipation	2	W
T_J	Operating Junction Temperature Range	-40 to 150	°C
T_{LEAD}	Maximum Soldering Temperature (at Leads)	300	

- Backlight Main and Sub are configured to be equal by default. Main and Sub can be programmed via AS²Cwire to be 4 Main and 2 Sub . For more information, see the Applications Information section of this datasheet.
- Stresses above those listed in Absolute Maximum Ratings may cause permanent damage to the device. Functional operation at conditions other than the operating conditions specified is not implied. Only one Absolute Maximum Rating should be applied at any one time.
- Derate 20mW/°C above 25°C ambient temperature.
- Mounted on a FR4 circuit board.

Backlight/Flash LED Driver and Triple LDO Lighting Management Unit

Electrical Characteristics¹

$V_{IN} = 3.6V$; $C_{IN} = C_{OUT} = 2.2\mu F$; $C_1 = C_2 = 1\mu F$; $T_A = -40^{\circ}C$ to $+85^{\circ}C$, unless otherwise noted. Typical values are $T_A = 25^{\circ}C$.

Symbol	Description	Conditions	Min	Typ	Max	Units
V_{IN}	IN Operating Voltage Range		2.7		5.5	V
I_{IN}	IN Operating Current (1x mode, Main Channels enabled, I_{BLX} not included)	EN/SET = PWMM = BL1-BL7 = IN, FL_EN = EN_LDOA/B/C = AGND;			600	μA
	IN Operating Current (2x mode, Main Channels enabled, I_{BLX} not included)	2x Mode; EN/SET= PWMM = IN, FL_EN = EN_LDOA/B/C = AGND; BL1-BL7 = OPEN; ADDR=12, DATA=15; ADDR=13, DATA=16			5.5	mA
	IN Operating Current (LDOA, LDOB and LDOC enabled)	EN/SET = PWMM = EN_LDOA/B/C = IN; FL_EN = AGND; ADDR = 0; DATA = 6; No Load			225	μA
$I_{IN(SHDN)}$	IN Shutdown Current	EN/SET, FL_EN, EN_LDOA/B/C, PWMM = AGND			1.0	μA
T_{SD}	Over-Temperature Shutdown Threshold			140		$^{\circ}C$
$T_{SD(HYS)}$	Over-Temperature Shutdown Hysteresis			15		$^{\circ}C$
Charge Pump Section						
V_{OUT}	OUT Output Voltage			5.2		V
$I_{OUT(MAX)}$	OUT Maximum Output Current	$V_{IN} = 3.0V, V_{OUT} = 4.0V$		800		mA
$V_{IN(TH,H, BL)}$	BL1-BL7 Charge Pump Mode Transition Hysteresis	EN/SET = IN; $V_{IN} - V_F = 1V$; ADDR=3, DATA=2; ADDR=2, DATA=12		0.3		V
$V_{IN(TH,H, FL)}$	FL1-FL2 Charge Pump Mode Transition Hysteresis	EN/SET = FL_EN = IN; $V_{IN} - V_F = 1V$; ADDR=10, DATA=1		1		V
f_{OSC}	Charge Pump Oscillator Frequency	$T_A = 25^{\circ}C$		1		MHz
$t_{CP(SS)}$	Charge Pump Soft-Start Time	$T_A = 25^{\circ}C$		100		μs
BL1-BL7, FL1, FL2 LED Drivers						
I_{BLx}	BL1-BL7 Current Accuracy	EN/SET = IN; $V_{IN} - V_F = 1V$; ADDR=3, DATA=3; ADDR=2, DATA=12	18	20	22	mA
I_{BL_x}	BL1-BL7 Current Accuracy	EN/SET = IN; $V_{IN} - V_F = 1V$; ADDR=3, DATA=4; ADDR=2, DATA=14	1.6	2	2.4	mA
$I_{BL_{(10\%)}}$	BL1-BL7 PWM Current Accuracy	DC=10%; $f_{PWM}=10kHz$; $V_{IN}-V_F=1.5V$		2.5		mA
$\frac{\Delta I_{(BLx)}}{I_{BL(AVG)}}$	BL1-BL7 Current Matching ²	EN/SET = IN; $V_{IN} - V_F = 1V$; ADDR=3, DATA=3; ADDR=2, DATA=12		3		%
$V_{BL_{(TH)}}$	BL1-BL7 Charge Pump Transition Threshold	EN/SET = IN; $V_{IN} - V_F = 1V$; ADDR=3, DATA=3; ADDR=2, DATA=12		0.2		V
$I_{FL[1]}$	FL1,FL2 Current Accuracy	EN/SET = FL_EN = IN; $V_{IN} - V_F = 1V$; ADDR=10, DATA=1	270	300	330	mA
$I_{FL[1](DATA13)}$	FL1, FL2 Current Accuracy	EN/SET = FL_EN = IN; $V_{IN} - V_F = 1V$; ADDR=10, DATA=13	54	60	66	mA
$\frac{\Delta I_{(FLx)}}{I_{FL(AVG)}}$	FL1-FL2 Current Matching	EN/SET = FL_EN = IN; $V_{IN} - V_F = 1V$; ADDR=10, DATA=1		5		%
$V_{FL[1/2](TH)}$	FL1,FL2 Charge Pump Transition Threshold	EN/SET = FL_EN = IN; $V_{IN} - V_F = 1V$; ADDR=10, DATA=1		0.45		V
$\Delta t_{FL}/t_{FL_SET}$	Flash Safety Timer Period	EN/SET = FL_EN = IN; $V_{IN} - V_F = 1V$; ADDR=11, DATA=1	1.5	2	2.5	s

1. The AAT2866 is guaranteed to meet performance specifications over the $-40^{\circ}C$ to $+85^{\circ}C$ operating temperature range and is assured by design, characterization, and correlation with statistical process controls.

2. Current matching is defined as the deviation of any sink current from the average of all active channels.

Backlight/Flash LED Driver and Triple LDO Lighting Management Unit**Electrical Characteristics¹**

$V_{IN} = 3.6V$; $C_{IN} = C_{OUT} = 2.2\mu F$; $C_1 = C_2 = 1\mu F$; $T_A = -40^\circ C$ to $+85^\circ C$, unless otherwise noted. Typical values are $T_A = 25^\circ C$.

Symbol	Description	Conditions	Min	Typ	Max	Units
Linear Regulators						
$\frac{\Delta V_{LDO[A/B/C]}}{V_{LDO[A/B/C]}}$	LDOA, LDOB, LDOC Output Voltage Tolerance	$I_{LDO} = 1mA$ to $200mA$; $T_A = 25^\circ C$	-1.5		1.5	%
		$I_{LDO} = 1mA$ to $200mA$; $T_A = -40^\circ C$ to $+85^\circ C$	-3.0		3.0	
$I_{LDO[A/B/C](MAX)}$	LDOA, LDOB, LDOC Maximum Load Current		200			mA
$V_{LDO[A/B/C](DO)}$	LDOA, LDOB, LDOC Dropout Voltage ²	$V_{LDO[A/B/C]} \geq 3.0V$; $I_{LDO} = 150mA$		75	150	mV
$\frac{\Delta V_{LDO}}{V_{LDO} * \Delta V_{IN}}$	LDOA, LDOB, LDOC Line Regulation	$V_{IN} = (V_{LDO[A/B/C]} + 1V)$ to $5V$		0.09		%/V
$PSRR_{[A/B/C]}$	LDOA, LDOB, LDOC Power Supply Rejection Ratio	$I_{LDO[A/B/C]} = 10mA$, $1kHz$		50		dB
R_{LDO_DCHG}	LDOA, LDOB, LDOC Auto-Discharge Resistance			1.5		k Ω
AS²Cwire and Logic Control						
V_{IH}	EN/SET, FL_EN, PWMM, EN_LDOA/B/C Input High Threshold Voltage	$2.7V \leq V_{IN} \leq 5.5V$	1.4			V
V_{IL}	EN/SET, FL_EN, PWMM, EN_LDOA/B/C Input Low Threshold Voltage	$2.7V \leq V_{IN} \leq 5.5V$			0.4	V
$I_{IN(LKG)}$	EN Input Leakage Current	EN/SET = PWMM = EN_LDOA/B/C = IN = 5V	-1		1	μA
$t_{EN/SET(OFF)}$	EN/SET Input OFF Timeout				500	μs
$t_{EN/SET(LAT)}$	EN/SET Input Latch Timeout				500	μs
$t_{EN/SET(LOW)}$	EN/SET Input LOW Time		0.3		75	μs
$t_{ENSET(H-MIN)}$	EN/SET Minimum High Time			50		ns
$t_{ENSET(H-MAX)}$	EN/SET Maximum High Time				75	μs

1. The AAT2866 is guaranteed to meet performance specifications over the $-40^\circ C$ to $+85^\circ C$ operating temperature range and is assured by design, characterization, and correlation with statistical process controls.

2. $V_{DO[A/B/C]}$ is defined as $V_{IN} - V_{LDO[A/B/C]}$ when $V_{LDO[A/B/C]}$ is 98% of nominal.

Backlight/Flash LED Driver and Triple LDO Lighting Management Unit

Typical Characteristics

Backlight Efficiency vs. Input Voltage

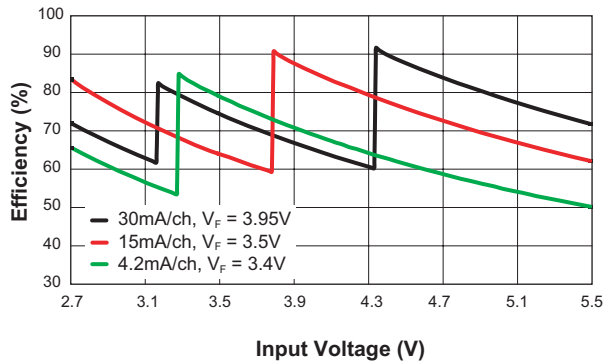

Flash Efficiency vs. Input Voltage

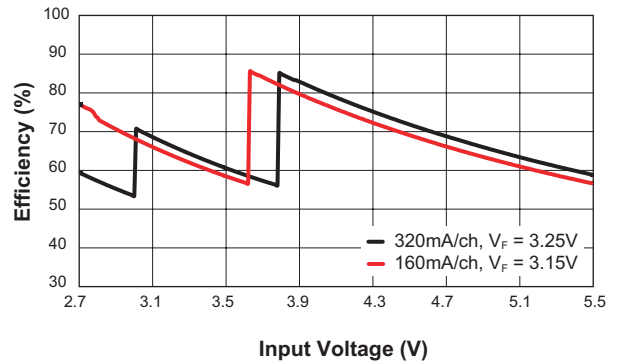

Backlight Current Matching vs. Temperature
($V_{IN} = 3.6V$; 20mA/ch)

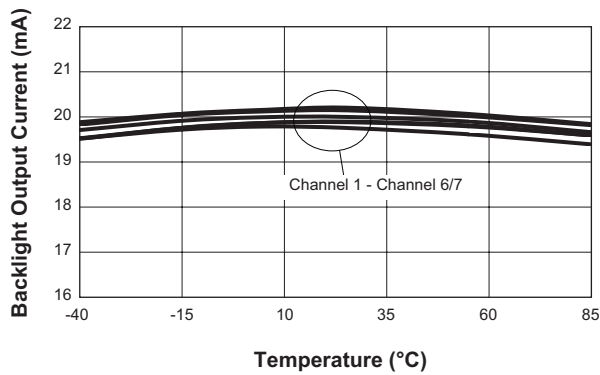

Charge Pump Output Turn On Characteristic
($V_{IN} = 3.6V$; 0mA/ch; $C_{OUT} = 2.2\mu F$)

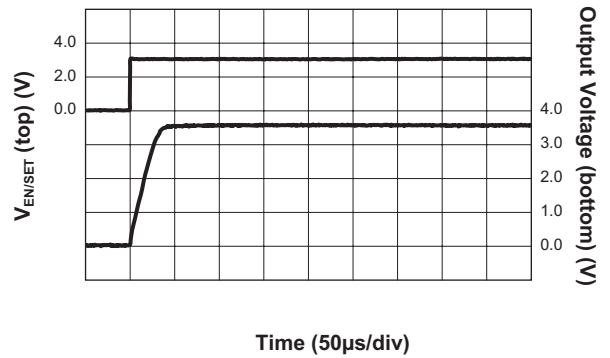

Turn On to 1x Mode Flash
($V_{IN} = 4.2V$; 300mA/ch)

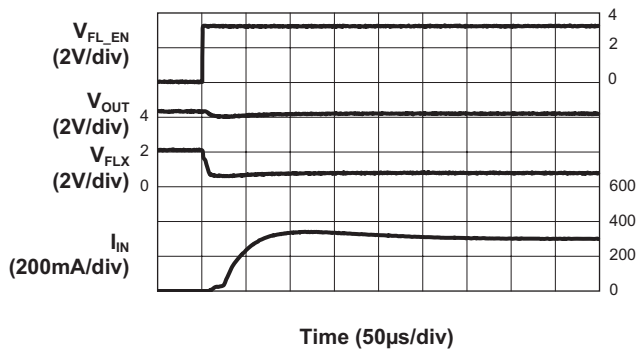

Turn On to 1.5x Mode Flash
($V_{IN} = 3.6V$; 300mA/ch)

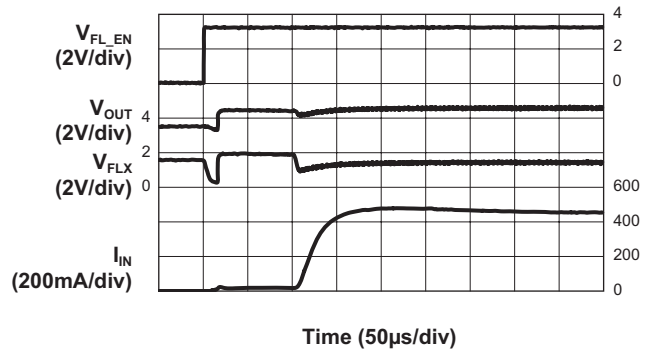

Backlight/Flash LED Driver and Triple LDO Lighting Management Unit

Typical Characteristics

Turn On to 2x Mode Flash
($V_{IN} = 2.8V$; 300mA/ch)

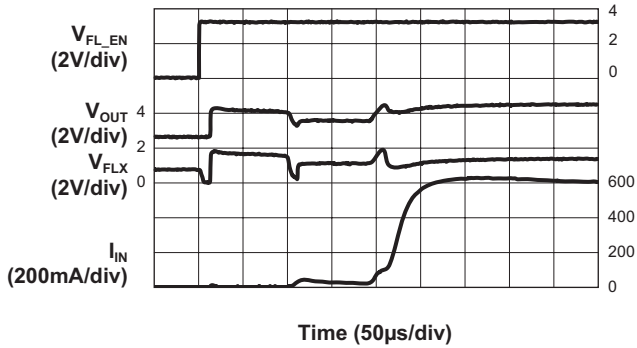

Turn On to 1x Mode Backlight
($V_{IN} = 4.2V$; 20mA/ch)

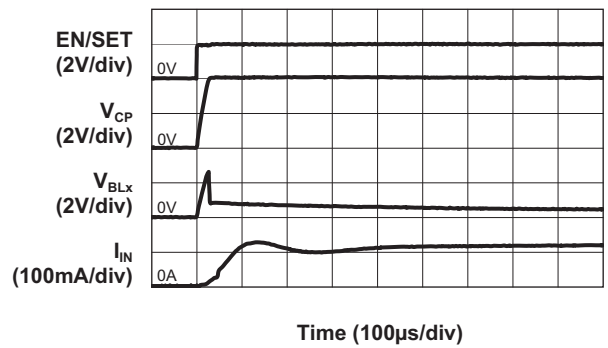

Turn On to 1.5x Mode Backlight
($V_{IN} = 3.2V$; 20mA/ch)

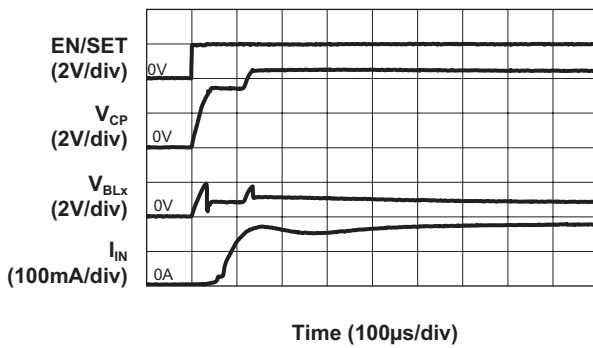

Turn On to 2x Mode Backlight
($V_{IN} = 2.7V$; 20mA/ch)

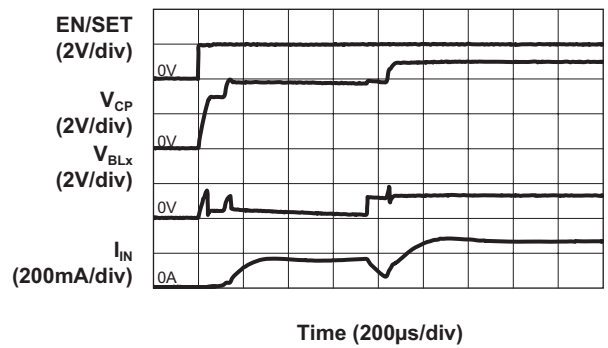

Turn Off from 1.5x Mode Backlight
($V_{IN} = 3.2V$; 20mA/ch)

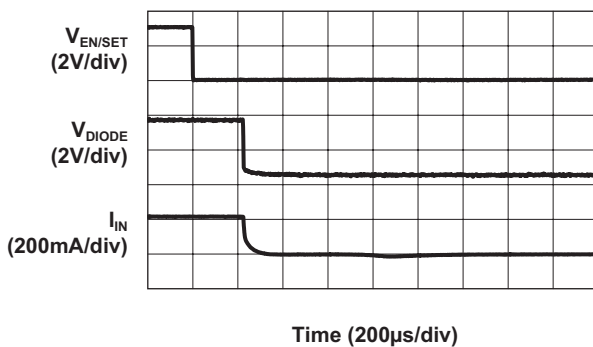

Operating Characteristic
($V_{IN} = 3.2V$; 20mA/ch Backlight; 1.5x Mode; $C_{OUT} = 2.2\mu F$)

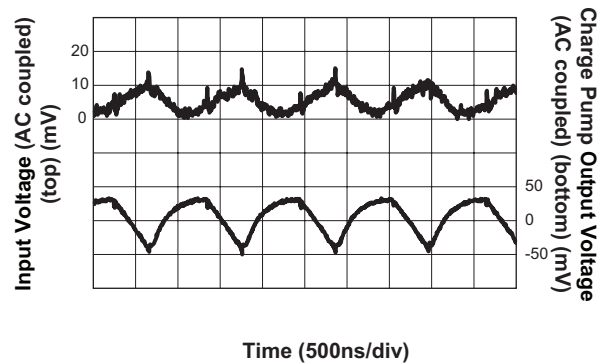

Backlight/Flash LED Driver and Triple LDO Lighting Management Unit

Typical Characteristics

Operating Characteristic

($V_{IN} = 3.0V$; 20mA/ch Backlight; 2x Mode; $C_{OUT} = 2.2\mu F$)

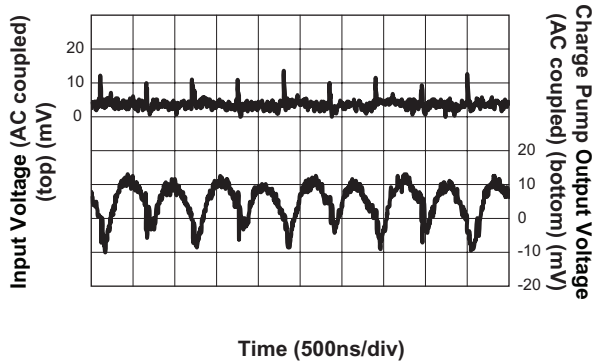

LDO Load Regulation vs. Output Current

($V_{OUT} = 1.2V$)

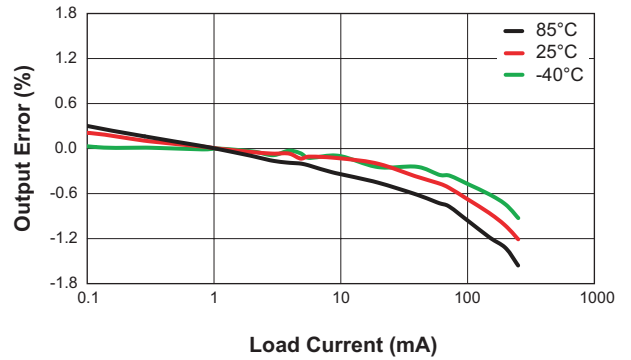

LDO A/B/C Output Voltage vs. Temperature

($V_{IN} = 3.6V$; $I_{LDO} = 0mA$)

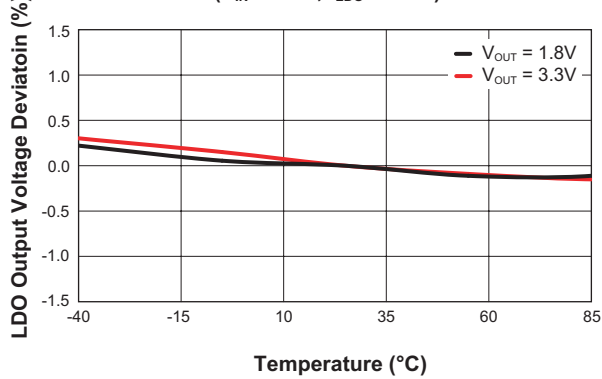

LDO A/B/C Load Transient Response

($I_{LDO} = 10mA$ to 200mA; $V_{IN} = 3.6V$; $V_{LDO} = 1.8V$; $C_{LDO} = 2.2\mu F$)

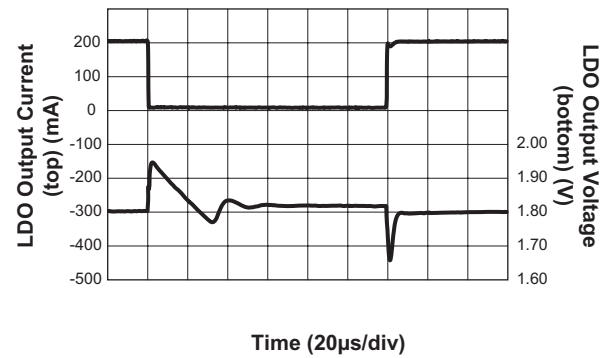

LDO A/B/C Line Transient Response

($V_{IN} = 3.6V$ to 4.2V; $I_{LDO} = 10mA$; $V_{OUT} = 1.8V$; $C_{LDO} = 2.2\mu F$)

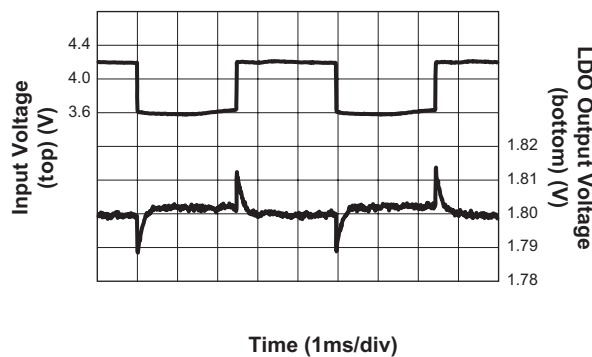

LDO A/B/C Turn On Characteristic

($V_{LDO} = 1.8V$; $V_{IN} = 3.6V$; $C_{LDO} = 2.2\mu F$)

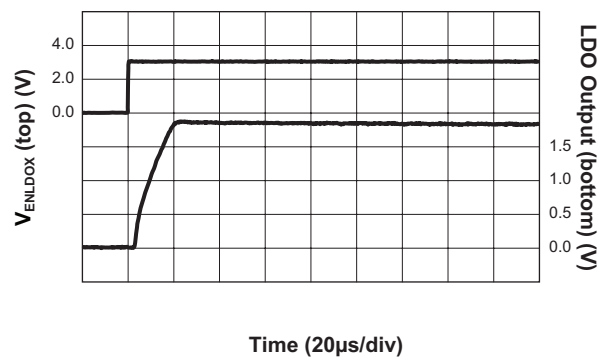

Backlight/Flash LED Driver and Triple LDO Lighting Management Unit

Typical Characteristics

EN/SET, FL_EN, PWMM, EN_LDOA/B/C
High Threshold Voltage vs. Input Voltage

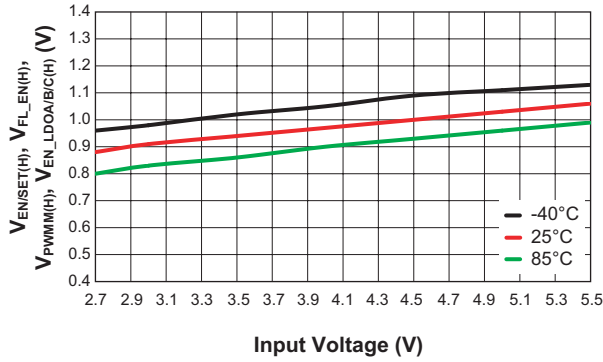

EN/SET, FL_EN, PWMM, EN_LDOA/B/C
Low Threshold Voltage vs. Input Voltage

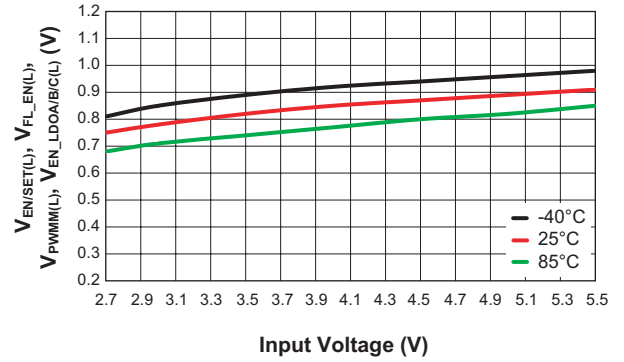

EN/SET Input Latch Timeout vs. Input Voltage

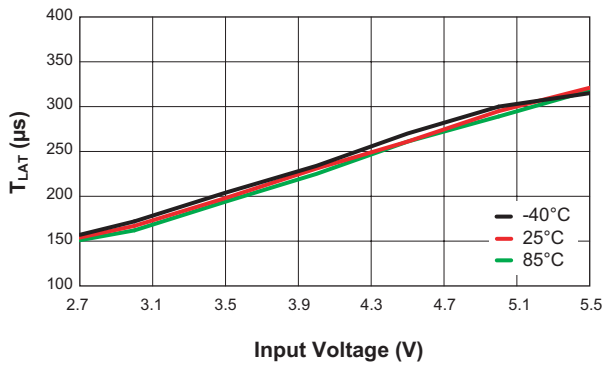

EN/SET Input Off Timeout vs. Input Voltage

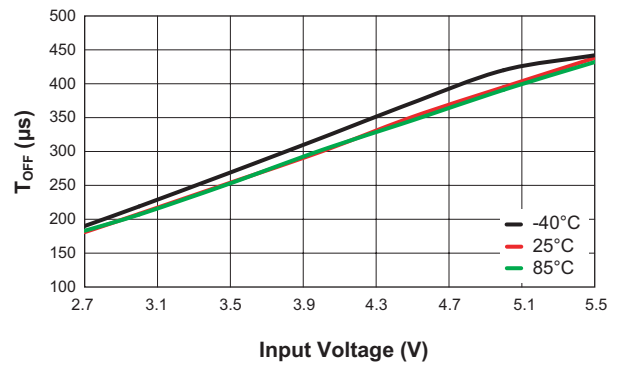

Backlight/Flash LED Driver and Triple LDO Lighting Management Unit

Functional Block Diagram

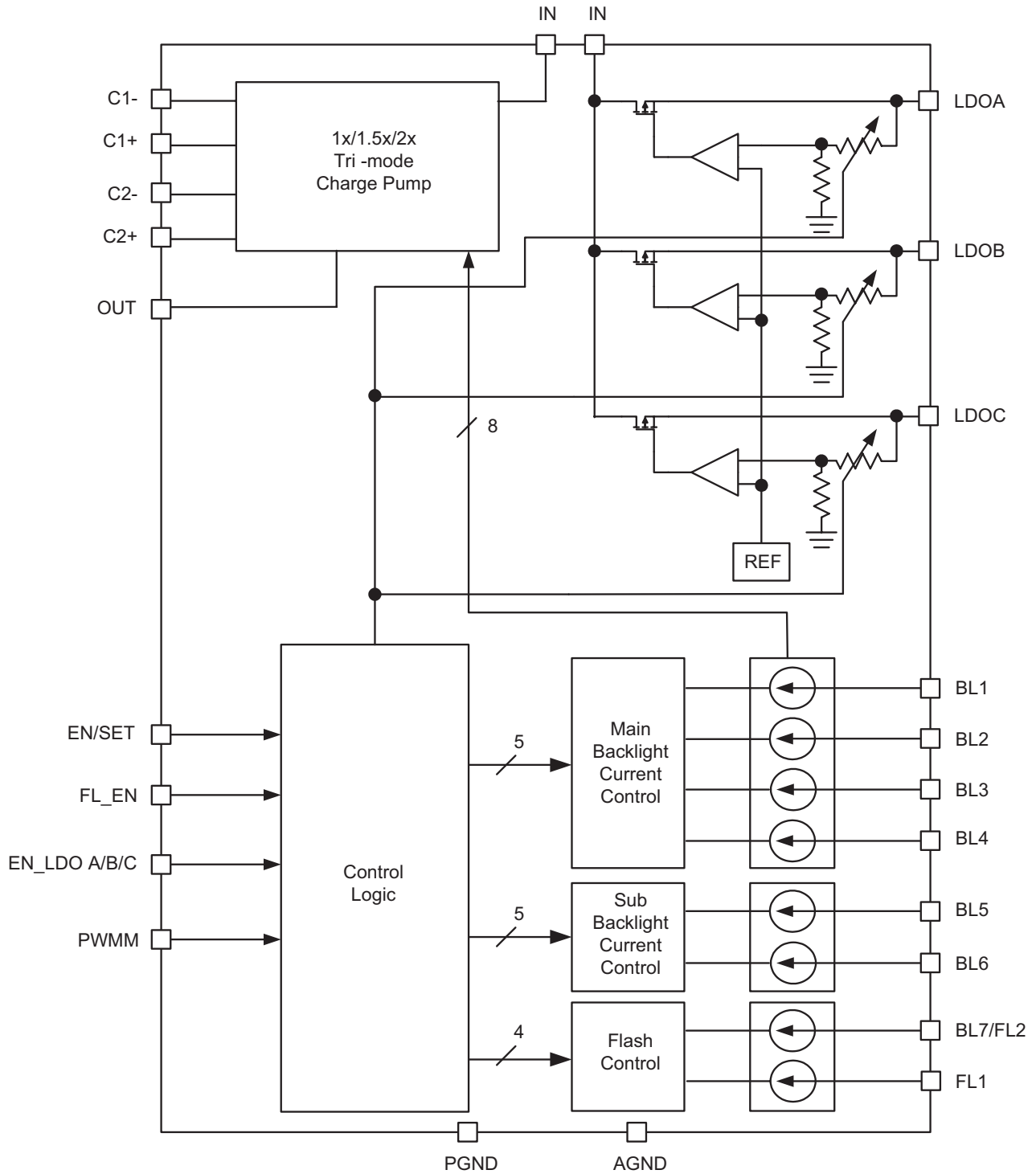

Backlight/Flash LED Driver and Triple LDO Lighting Management Unit**Functional Description**

The AAT2866 is a highly integrated backlight and photo-flash driver family with three LDO regulators. The charge pump LED driver powers the backlight and flash LEDs from the 2.7V to 5.5V input voltage. The LDO regulators get their power from the same input and produce regulated output voltages between 1.2V and 3.3V. Control of the LEDs and the LDO output voltages are through an AS²Cwire serial interface for easy programming. In addition, BL1-BL6 (AAT2866) or BL1-BL7 (AAT2866-3) LED current can be controlled via an external PWM signal.

LED Drivers

The AAT2866 drives six backlight LEDs up to 31mA each and a total of 600mA flash current through two channels. The LEDs are driven from a charge pump to insure that constant current is maintained for all possible LED forward voltages over the entire battery voltage range. The charge pump automatically switches from 1x, to 1.5x, to 2x modes and back to maintain the LED current while minimizing power loss for high efficiency. The charge pump operates at the high 1MHz switching frequency allowing the use of small 1 μ F ceramic capacitors. Each individual LED is driven by a current sink to GND, allowing individual current control with high accuracy over a wide range of input voltages and LED forward voltages while maintaining high efficiency.

The charge pump is controlled by the voltage across the LED current sinks. When any one of the active backlight current sink voltages drops below 200mV or the flash current sink drops below 450mV, the charge pump goes to the next higher mode (from 1x to 1.5x or from 1.5x to 2x mode) to maintain sufficient LED voltage for constant LED current. The AAT2866 continuously monitors the LED forward voltages and uses the input voltage to determine when to reduce the charge pump mode for better efficiency. There is also a 300mV mode-transition hysteresis that prevents the charge pump from oscillating between modes.

LED Current Control

Both the backlight and flash LED currents are controlled through the AS²Cwire serial interface. The backlight LED current can be set between 0.5mA and 31mA in approximately 1mA steps while the flash LED current can be set between 0 to 300mA in 20mA steps for each channel.

The backlight LED currents match to within 3% while the flash LED currents match to within 5%.

To eliminate the latency of the AS²Cwire serial interface, the flash LED is enabled through a dedicated input, FL_EN. The AAT2866 also includes a safety timer that prevents overstress of the flash LEDs. This is important because many flash LEDs operate for a brief period beyond their steady-state operating limitations. If the flash driving hardware and/or software fails to turn the LED off, the safety timer insures that the LED or other circuitry is not damaged.

Both the backlight and flash LED currents are programmed through the AS²Cwire serial interface including the flash safety timer. See the "AS²Cwire Serial Interface Programming" section for more information on setting the LED currents.

PWM Controlled Dimming

As an alternative to digital dimming via the AS²Cwire serial interface, the AAT2866 also provides an additional pin, PWMM, which allows the user to control BL1-BL6 (AAT2866) or BL1-BL7 (AAT2866-3) or the Main BL1-BL4 (AAT2866) or BL1-BL5 (AAT2866-3) (optional, when MEQS is deactivated) backlight LEDs with a PWM signal. The Sub backlight channels BL5-BL6 (AAT2866) or BL6-BL7 (AAT2866-3) current is set by AS²Cwire interface. The PWM signal will modulate the LED current set by AS²Cwire programming or the AAT2866 default current. In this mode the minimum PWM frequency is 60Hz. PWM frequencies as high as 100kHz can be used.

LDO Regulators

The AAT2866 family includes three low dropout (LDO) linear regulators. These regulators are powered from the battery and produce fixed output voltages set through the AS²Cwire serial interface. The output voltage can be set to one of 16 output voltages between 1.2V and 3.3V. The LDO regulators can be turned on/off with the external enable pin EN_LDOA/B/C. Additionally, the AS²Cwire interface allows the LDO regulators to be enabled independently when the EN_LDOA/B/C pin is pulled high.

All LDO regulators require only small 2.2 μ F ceramic output capacitors for stability. If improved load transient response is required, larger-valued capacitors can be used without stability degradation.

Backlight/Flash LED Driver and Triple LDO Lighting Management Unit

AS²Cwire Serial Interface Protocol

The AAT2866 is dynamically programmable by the AS²Cwire single-wire interface. AS²Cwire records rising edges detected at the EN/SET pin to address and load the data registers. The timing diagram in Figure 1 shows the typical transmission protocol.

AS²Cwire latches data or address after the EN/SET input has been held high for time t_{LAT} (500 μ s). Address or data is differentiated by the number of EN/SET rising edges. Since the data registers are 4 bits each, the differentiating number of pulses is 2⁴ or 16, so that Address 0 is identified by 17 rising edges, Address 1 by 18 rising edges, Address 2 by 19 rising edges, etc. Data is set to any number of rising edges between 1 and 16. A typical write protocol is a burst of EN/SET rising edges identifying a particular address, followed by a pause with EN/SET held high for the t_{LAT} time-out period, then a burst of rising edges signifying data, and another t_{LAT} timeout after the data has been sent. Once an address is set, multiple writes to that address are allowed since the address is not reset after each write. Address edges are needed when

changing the address, or writing to an address other than the default after shutdown. Address 0 is the default address after shutdown. If the part is enabled with only data edges and no address, then Address 0 will be programmed and LED Backlight channels BL1-BL6 (AAT2866) or BL1-BL7 (AAT2866-3) will be enabled according to the number of data edges applied.

When EN/SET is held low for a time longer than t_{OFF} (500 μ s), the AAT2866 enters shutdown mode and draws less than 1 μ A of current from IN. At shutdown, the data and address registers are reset to 0.

AS²Cwire Serial Interface Programming

The AAT2866's AS²C programming Address registers are listed in Table 1. There are 13 active Address registers; four control the three LDOs, four control the backlight LED configuration/control, two control the flash current and timer control, two are used to individually disable each backlight or flash channel, and one is reserved for test purposes.

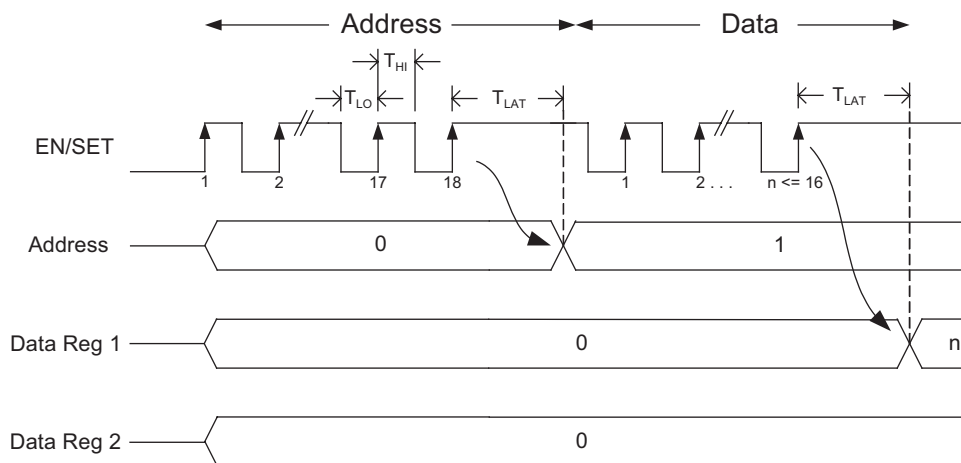

Figure 1: AS²Cwire Serial Interface Timing Diagram.

Backlight/Flash LED Driver and Triple LDO Lighting Management Unit

Address	EN/SET Rising Edges	Function	D3	D2	D1	D0
0	17	Backlight Main/Sub	Reserved	Reserved	SUB_OFF	MAIN_OFF
1	18	Reserved	Reserved	Reserved	Reserved	Reserved
2	19	Backlight Current Main, LSBs	BLM[3]	BLM[2]	BLM[1]	BLM[0]
3	20	Backlight Current Main, MSB	Reserved	X	MEQS*	BLM[4]
4	21	Backlight Current Sub, LSBs	BLS[3]	BLS[2]	BLS[1]	BLS[0]
5	22	Backlight Current Sub, MSB	X	X	X	BLS[4]
6	23	LDO Disable Control	X	OFF_LDOC	OFF_LDOB	OFF_LDOA
7	24	LDO A Output Voltage Control	LDOA[3]	LDOA[2]	LDOA[1]	LDOA[0]
8	25	LDO B Output Voltage Control	LDOB[3]	LDOB[2]	LDOB[1]	LDOB[0]
9	26	LDO C Output Voltage Control	LDOC[3]	LDOC[2]	LDOC[1]	LDOC[0]
10	27	Flash Current	F_HI[3]	F_HI[2]	F_HI[1]	F_HI[0]
11	28	Flash Timer Control	X	X	F_TIME[1]*	F_TIME[0]*
12	29	LED Channel Disable Control (BL1 – BL4)	OFF_BL4	OFF_BL3	OFF_BL2	OFF_BL1
13	30	LED Channel Disable Control (BL5, BL6, FL1, FL2)	OFF_FL1	OFF_FL2	OFF_BL6	OFF_BL5

Table 1: AAT2866 Configuration/Control Register Allocation.**Backlight Main and Sub Control (Address 0)**

Address 0 controls the enabling of the Main and Sub channels. Table 2 shows the Data Codes used to control the Main and Sub Channels independently. The default condition for all backlight outputs (BL1-BL6) is ON after power-up.

At startup when the EN/SET pin is first pulled high, Address 0 is the default active register. The main and sub channels can be turned off by immediately writing data. For example, if Data=3 is written, the main channels will turn off and the sub channels will turn on to the default value of 20mA.

Data	Sub Channel On	Main Channel On
1*	On*	On*
2	On	Off
3	Off	On
4	Off	Off

Table 2: Backlight Main/Sub Enable (Address 0).**Backlight Current Control (Addresses 2 to 5)**

The AAT2866's AS²Cwire Addresses 2, 3, 4, and 5 control the backlight LED output current level in each group of outputs. Address 2 and Address 3 control the Main channel backlight current to one of 32 levels according to Table 3 below. Address 3 acts as the MSB for the current levels. Address 4 and Address 5 control the Sub channel backlight current to one of 32 levels according to Table 4 below.

The current settings for the Main and Sub channels are each divided into two Addresses. Any change in Data to the "Backlight Current Main (or Sub), LSB's" Address will result in an immediate change to the LED current output level. When the Data in "Backlight Current Main (or Sub), MSB" Address is changed, the new current setting will not take effect until "Backlight Current Main (or Sub), LSB's" Address has been written to and latched.

For example, a change from 28mA to 8mA in the Main backlight channels should follow this procedure. First, 28mA is set by programming Data = 3 to Address 2 and Data=1 to Address 3. When changing to 8mA first write Data=2 to Address 3. The current level will not change after this step. Then write Data=7 to Address 2. After Address 2 has been latched the new 8mA current level will be set.

"*" signifies that the data bit has a POR default bit value = 1; "X" signifies "Don't care."

Backlight/Flash LED Driver and Triple LDO Lighting Management Unit

Main Equals Sub OFF (MEQS=0)					Main Equals Sub ON (MEQS=1)				
Address	Data	Address	Data	Main Current	Address	Data	Address	Data	Main Current
3	1	2	1	31	3	3	2	1	31
3	1	2	2	30	3	3	2	2	30
3	1	2	3	29	3	3	2	3	29
3	1	2	4	28	3	3	2	4	28
3	1	2	5	27	3	3	2	5	27
3	1	2	6	26	3	3	2	6	26
3	1	2	7	25	3	3	2	7	25
3	1	2	8	24	3	3	2	8	24
3	1	2	9	23	3	3	2	9	23
3	1	2	10	22	3	3	2	10	22
3	1	2	11	21	3	3	2	11	21
3	1*	2	12*	20*	3	3	2	12	20
3	1	2	13	19	3	3	2	13	19
3	1	2	14	18	3	3	2	14	18
3	1	2	15	17	3	3	2	15	17
3	1	2	16	16	3	3	2	16	16
3	2	2	1	15	3	4	2	1	15
3	2	2	2	14	3	4	2	2	14
3	2	2	3	13	3	4	2	3	13
3	2	2	4	12	3	4	2	4	12
3	2	2	5	11	3	4	2	5	11
3	2	2	6	10	3	4	2	6	10
3	2	2	7	9	3	4	2	7	9
3	2	2	8	8	3	4	2	8	8
3	2	2	9	7	3	4	2	9	7
3	2	2	10	6	3	4	2	10	6
3	2	2	11	5	3	4	2	11	5
3	2	2	12	4	3	4	2	12	4
3	2	2	13	3	3	4	2	13	3
3	2	2	14	2	3	4	2	14	2
3	2	2	15	1	3	4	2	15	1
3	2	2	16	0.5	3	4	2	16	0.5

Table 3: Backlight Main Current Control (Addresses 2 and 3).

* denotes the register's default (power-on-reset) value.

Backlight/Flash LED Driver and Triple LDO Lighting Management Unit

Sub Backlight				
Address	Data	Address	Data	Sub Current
5	1	4	1	31
5	1	4	2	30
5	1	4	3	29
5	1	4	4	28
5	1	4	5	27
5	1	4	6	26
5	1	4	7	25
5	1	4	8	24
5	1	4	9	23
5	1	4	10	22
5	1	4	11	21
5	1*	4	12*	20*
5	1	4	13	19
5	1	4	14	18
5	1	4	15	17
5	1	4	16	16
5	2	4	1	15
5	2	4	2	14
5	2	4	3	13
5	2	4	4	12
5	2	4	5	11
5	2	4	6	10
5	2	4	7	9
5	2	4	8	8
5	2	4	9	7
5	2	4	10	6
5	2	4	11	5
5	2	4	12	4
5	2	4	13	3
5	2	4	14	2
5	2	4	15	1
5	2	4	16	0.5

Table 4: Backlight Sub Current Control (Addresses 4 and 5).

Table 5 shows the Main and Sub Channel Configurations for the AAT2866. The effect of the “Main Equals Sub” feature is clearly represented in Table 5.

Part Number	Main Equals Sub ($I_{MAIN} = I_{SUB}$)	
	Yes (Default)	No
AAT2866	6M+0S+2FL	4M+2S+2FL
AAT2866-3	5M+2S+1FL	n/a

Table 5: “Main Equals Sub” Control.

LDO Output Voltage Control (Addresses 6 to 9)

Configuring the AAT2866’s three LDO regulators is performed by programming Addresses 6, 7, 8, and 9 over the AS²C interface. With the EN/SET pin pulled high and the AAT2866 turned on, LDO A and LDO B and LDO C can be enabled together using the EN_LDOA/B/C pin. Additional LDO regulator control can be achieved using Address 6 to override the enable command of the EN_LDOA/B/C pins as shown in Table 6. For example, with the EN_LDOA/B/C pins enabled, writing Data 5 to Address 6 will disable LDO C and leave LDO A and LDO B enabled. Table 6 shows the LDO disable control.

Writing Data to Addresses 7, 8, and 9 set the output voltages for LDO A, LDO B, and LDO C to one of 16 levels. The available LDO output voltages are shown in Table 7.

Fast turn-off response time is achieved by an active output pull-down circuit, which is enabled when the LDO regulator is disabled.

Data	LDO C	LDO B	LDO A
1*	Controlled by EN_LDOA/B/C*	Controlled by EN_LDOA/B/C*	Controlled by EN_LDOA/B/C*
2	Controlled by EN_LDOA/B/C	Controlled by EN_LDOA/B/C	OFF
3	Controlled by EN_LDOA/B/C	OFF	Controlled by EN_LDOA/B/C
4	Controlled by EN_LDOA/B/C	OFF	OFF
5	OFF	Controlled by EN_LDOA/B/C	Controlled by EN_LDOA/B/C
6	OFF	Controlled by EN_LDOA/B/C	OFF
7	OFF	OFF	Controlled by EN_LDOA/B/C
8	OFF	OFF	OFF

Table 6: LDO Disable Control (Address 6).

* denotes the register’s default (power-on-reset) value.

Backlight/Flash LED Driver and Triple LDO Lighting Management Unit

Data	LDO V _{LDO[A/B/C]} (V)
1	1.2
2	1.3
3	1.5
4	1.6
5*	1.8*
6	2
7	2.2
8	2.5
9	2.6
10	2.7
11	2.8
12	2.9
13	3
14	3.1
15	3.2
16	3.3

Table 7: LDO X Output Voltage (Addresses 7, 8, and 9).

Flash Driver Control (Address 10 and 11)

The AAT2866 has two LED Flash channel and the AAT2866-3 has one LED Flash channel. Each is capable of driving 300mA per channel. Address 10 programs the flash current level. Table 8 lists the Data Codes for the programming Address 10. Upon startup, the power-on-reset value in Address 10 is set to Data Code 13.

Once the EN/SET pin is pulled high and the AAT2866 has turned on, the LED Flash channels can be enabled by pulling the FL_EN to V_{IN}. The current setting of the LED Flash channels can be changed prior to enabling the flash current, or while the flash current is on.

The LED Flash controller also comes with a safety timer to prevent excessive heat generation and power loss from extended high current power dissipation. The LED flash safety timer duration can be set to four values by writing to Address 11. The Flash timer defaults to the OFF state (DATA 16) at startup. Table 9 shows the Data Codes for the flash safety timer.

Torch/Movie mode is automatically entered when the flash current setting is programmed to 60mA or less per channel (Data = 13, 14, or 15). All of the flash channels will remain on as long as the FL_EN pin remains active. The Flash Safety Timer can be enabled by writing ADDR=11, DATA=1, 2, or 3. Though the AAT2866

includes an internal thermal limit circuit, be careful to limit the current setting (Address 10) to a value that will not generate excessive heat which may damage the flash LEDs or other external circuitry.

Data	Flash Current (mA) per Output
1	300
2	280
3	260
4	240
5	220
6	200
7	180
8	160
9	140
10	120
11	100
12	80
13*	60*
14	40
15	20
16	OFF

Table 8: Flash Current Level (Address 10).

Data	Flash Time (sec)
1	2
2	1
3	0.5
4*	OFF

Table 9: Flash Safety Timer (Address 11).

LED Channel Disable Control (Address 12 and 13)

Addresses 12 and 13 allow for additional programming flexibility by allowing each LED channel to be independently disabled. Normally, the backlight channels are controlled by MAIN_OFF and SUB_OFF controls in Address 0, while the FL_EN pin turns on the flash channels. Writing to Addresses 12 and 13 can override these controls to allow for any combination of LEDs to be turned on. The default state is for all LED channels to be "ON."

In the following example we see how to turn on BL1, BL2, BL5, and BL6. First write Address 12, Data=13 and Address 13, Data=13 to disable BL3, BL4, FL1, and FL2. Then program the desired current setting using Addresses 2 through 5.

* denotes the register's default (power-on-reset) value.

Backlight/Flash LED Driver and Triple LDO Lighting Management Unit

Data	BL4	BL3	BL2	BL1
1*	ON*	ON *	ON*	ON*
2	ON	ON	ON	OFF
3	ON	ON	OFF	ON
4	ON	ON	OFF	OFF
5	ON	OFF	ON	ON
6	ON	OFF	ON	OFF
7	ON	OFF	OFF	ON
8	ON	OFF	OFF	OFF
9	OFF	ON	ON	ON
10	OFF	ON	ON	OFF
11	OFF	ON	OFF	ON
12	OFF	ON	OFF	OFF
13	OFF	OFF	ON	ON
14	OFF	OFF	ON	OFF
15	OFF	OFF	OFF	ON
16	OFF	OFF	OFF	OFF

Table 10: LED Channel Disable Control, BL1-BL4 (Address 12).

Data	FL1	FL2	BL6	BL5
1*	ON*	ON *	ON*	ON*
2	ON	ON	ON	OFF
3	ON	ON	OFF	ON
4	ON	ON	OFF	OFF
5	ON	OFF	ON	ON
6	ON	OFF	ON	OFF
7	ON	OFF	OFF	ON
8	ON	OFF	OFF	OFF
9	OFF	ON	ON	ON
10	OFF	ON	ON	OFF
11	OFF	ON	OFF	ON
12	OFF	ON	OFF	OFF
13	OFF	OFF	ON	ON
14	OFF	OFF	ON	OFF
15	OFF	OFF	OFF	ON
16	OFF	OFF	OFF	OFF

Table 11: LED Channel Disable Control, BL5, BL6, FL1, BL7/FL2 (Address 13).

* denotes the register's default (power-on-reset) value.

Backlight/Flash LED Driver and Triple LDO Lighting Management Unit**PWM Control**

PWM (Pulse Width Modulation) is an industry-standard technique of controlling LED brightness by modulating the conduction duty cycle of the LED current. LED brightness is determined by the average value of the PWM signal multiplied by the LED's intensity, where intensity is proportional to the LED drive current. A PWM control signal can be applied to the PWMM pin of the AAT2866. By changing the duty cycle of the PWM signal from 100% to 0% the LED current can be linearly modulated from the programmed current setting to a floor level of 0.5mA. Lastly, Table 12 and Figure 2 illustrate the AAT2866 LED current control profile as a function of a PWM control signal for 20mA programmed current setting.

EN/PWM Duty Cycle	D1-D3 Current (mA)
100%	20.0
90%	18.2
80%	16.2
70%	14.2
60%	12.2
50%	10.4
40%	8.4
30%	6.5
20%	4.5
10%	2.5

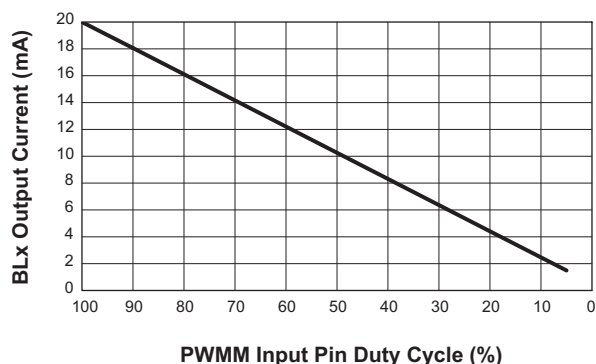
Table 12: AAT2866 LED PWM Current Settings.**AAT2866 Current Control Profile
(10kHz)****Figure 2: AAT2866 PWM Current Control Profile.****Applications Information****LED Selection**

The AAT2866 is specifically intended for driving white LEDs. However, the device design will allow the AAT2866 to drive most types of LEDs with forward voltage specifications ranging from 2.0V to 4.7V. LED applications may include mixed arrangements for display backlighting, color (RGB) LEDs, infrared (IR) diodes and any other load needing a constant current source generated from a varying input voltage. Since the D1 to D4 constant current sinks are matched with negligible voltage dependence, the constant current channels will be matched regardless of the specific LED forward voltage (V_F) levels.

The *low-dropout* current sinks in the AAT2866 maximize performance and make it capable of driving LEDs with high forward voltages. Multiple channels can be combined to obtain a higher LED drive current without complication.

Device Switching Noise Performance

The AAT2866 operates at a fixed frequency of approximately 1MHz to control noise and limit harmonics that can interfere with the RF operation of cellular telephone handsets or other communication devices. Back-injected noise appearing on the input pin of the Charge Pump is 20mV peak-to-peak, typically ten times less than inductor-based DC/DC boost converter white LED backlight solutions. The AAT2866 soft-start feature prevents noise transient effects associated with in-rush currents during the start up of the charge pump circuit.

Power Efficiency and Device Evaluation

Charge-pump efficiency discussion in the following sections accounts only for the efficiency of the charge pump section itself. Due to the unique circuit architecture and design of the AAT2866, it is very difficult to measure efficiency in terms of a percent value comparing input power over output power.

Since the AAT2866 outputs are pure constant current sinks and typically drive individual loads, it is difficult to measure the output voltage for a given output (BL1 to BL6, and FL1/FL2) to derive an overall output power measurement. For any given application, white LED forward voltage levels can differ, yet the output drive current will be maintained as a constant.

Backlight/Flash LED Driver and Triple LDO Lighting Management Unit

This makes quantifying output power a difficult task when taken in the context of comparing to other white LED driver circuit topologies. A better way to quantify total device efficiency is to observe the total input power to the device for a given LED current drive level. The *best* White LED driver for a given application should be based on trade-offs of size, external component count, reliability, operating range and total energy usage...*not just "% efficiency"*.

The AAT2866 efficiency may be quantified under very specific conditions and is dependent upon the input voltage versus the output voltage seen across the loads applied to outputs D1 through D4 for a given constant current setting. Depending on the combination of V_{IN} and voltages sensed at the current sinks, the device will operate in "Load Switch" mode. When any one of the voltages sensed at the current sinks nears dropout the device will operate in 1.5x or 2x charge pump mode. Each of these modes will yield different efficiency values. One should refer to the following two sections for explanations for each operational mode.

1x Mode Efficiency

The AAT2866 1x mode is operational at all times and functions alone to enhance device power conversion efficiency when V_{IN} is greater than the voltage across the load. When in 1x mode, the voltage conversion efficiency is defined as output power divided by input power:

$$\eta = \frac{P_{OUT}}{P_{IN}}$$

The expression to define the ideal efficiency (η) can be rewritten as:

$$\eta = \frac{P_{OUT}}{P_{IN}} = \frac{V_{OUT} \cdot I_{OUT}}{V_{IN} \cdot I_{OUT}} = \frac{V_{OUT}}{V_{IN}}$$

-or-

$$\eta(\%) = 100 \left(\frac{V_{OUT}}{V_{IN}} \right)$$

1.5x/2x Charge Pump Mode Efficiency

The AAT2866 contains a fractional charge pump which will boost the input supply voltage in the event where V_{IN} is less than the voltage required to supply the output. The efficiency (η) can be simply defined as a linear voltage regulator with an effective output voltage that is equal to one and a half or two times the input voltage. Efficiency (η) for an ideal 1.5x charge pump can typically be expressed as the output power divided by the input power.

$$\eta = \frac{P_{OUT}}{P_{IN}}$$

In addition, with an ideal 1.5x charge pump, the output current may be expressed as 2/3 of the input current. The expression to define the ideal efficiency (η) can be rewritten as:

$$\eta = \frac{P_{OUT}}{P_{IN}} = \frac{V_{OUT} \cdot I_{OUT}}{V_{IN} \cdot 1.5I_{OUT}} = \frac{V_{OUT}}{1.5V_{IN}}$$

$$\eta(\%) = 100 \left(\frac{V_{OUT}}{1.5V_{IN}} \right)$$

For a charge pump with an output of 5V and a nominal input of 3.5V, the theoretical efficiency is 95%. Due to internal switching losses and IC quiescent current consumption, the actual efficiency can be measured at 93%. These figures are in close agreement for output load conditions from 1mA to 100mA. Efficiency will decrease substantially as load current drops below 1mA or when level of V_{IN} approaches V_{OUT} .

The same calculations apply for 2x mode where the output current then becomes 1/2 of the input current.

Capacitor Selection

Careful selection of the four external capacitors C_{IN} , C1, C2, C_{OUT} is important because they will affect turn on time, output ripple and transient performance. Optimum performance will be obtained when low ESR (<100m Ω) ceramic capacitors are used. In general, low ESR may be defined as less than 100m Ω . A capacitor value of 1 μ F for all four capacitors is a good starting point when choosing capacitors. If the constant current sinks are only programmed for light current levels, then the capacitor size may be decreased.

Capacitor Characteristics

Ceramic composition capacitors are highly recommended over all other types of capacitors for use with the AAT2866. Ceramic capacitors offer many advantages over their tantalum and aluminum electrolytic counterparts. A ceramic capacitor typically has very low ESR, is lowest cost, has a smaller PCB footprint and is non-polarized. Low ESR ceramic capacitors help to maximize charge pump transient response. Since ceramic capacitors are non-polarized, they are not prone to incorrect connection damage.

Backlight/Flash LED Driver and Triple LDO Lighting Management Unit**Equivalent Series Resistance (ESR)**

ESR is an important characteristic to consider when selecting a capacitor. ESR is a resistance internal to a capacitor, which is caused by the leads, internal connections, size or area, material composition and ambient temperature. Capacitor ESR is typically measured in milliohms for ceramic capacitors and can range to more than several ohms for tantalum or aluminum electrolytic capacitors.

Ceramic Capacitor Materials

Ceramic capacitors less than 0.1 μ F are typically made from NPO or C0G materials. NPO and C0G materials typically have tight tolerance and are stable over temperature. Larger capacitor values are typically composed of X7R, X5R, Z5U or Y5V dielectric materials. Large ceramic capacitors, typically greater than 2.2 μ F are often available in low cost Y5V and Z5U dielectrics, but capacitors greater than 1 μ F are typically not required for AAT2866 applications.

Capacitor area is another contributor to ESR. Capacitors that are physically large will have a lower ESR when compared to an equivalent material smaller capacitor. These larger devices can improve circuit transient response when compared to an equal value capacitor in a smaller package size.

Evaluation Board User Interface

The user interface for the AAT2866 evaluation board is provided by four buttons and two connection terminals. The board is operated by supplying external power and pressing individual buttons or button combinations. The table below indicates the function of each button or button combination.

To power-on the evaluation board, connect a power supply or battery to the DC- and DC+ terminals. Close the board's supply connection by positioning the J1 jumper to the ON position. A red LED indicates that power is applied.

The evaluation board is made flexible so that the user can disconnect the enable line from the microcontroller and apply an external enable signal. By removing the jumper from J2, external LDO enable signal can be applied to the board. If PWM function is not desired, PWMM also needs to be connected to a high potential.

When applying external enable signals, consideration must be given to the voltage levels. The externally applied voltages should not exceed the supply voltage that is applied to the IN pins of the device (DC+).

The LDO loads can be connected directly to the evaluation board. For adequate performance, be sure to connect the load between OUTA/OUTB/OUTC and DC- as opposed to some other GND in the system.

Manufacturer	Part Number	Value	Voltage	Temp. Co.	Case
AVX	0603ZD105K	1 μ F	10	X5R	0603
	0603ZD225K	2.2 μ F	10		
TDK	C1608X5R1E105K	1 μ F	25	X5R	0603
	C1608X5R1C225K	2.2 μ F	16		
	C1608X5R1A475K	4.7 μ F	10		
Murata	GRM188R61C105K	1 μ F	16	X5R	0603
	GRM188R61A225K	2.2 μ F	10		
Taiyo Yuden	LMK107BJ475KA	4.7 μ F	10	X5R	0603

Table 13: Surface Mount Capacitors.

Button(s) Pushed	Description
SW1 (LDOs)	[Push/Release once] All LDOs will be turned on with default output voltage 1.2V. Every push release will increment output voltage according to datasheet table.
SW2 (Backlight)	[Push/Release once] Turning on all backlight LEDs with default current 31mA per channel. Every push release will decrement the current according to datasheet table.
SW3 (Flash)	[Push/Release once] Programming data to the flash LEDs with default current 300mA per channel. Every push release will decrement the current according to datasheet table.
SW4 (Flash Enable)	[Push/Release once] Turning on the flash LEDs with default timer 2sec for flash Data 1 through Data 12. Flash Data 13, 14 and 15 will disable automatically the timer function.

Table 14: User Interface Functionality Between AAT2866 and the PIC Microcontroller.

AAT2866

Backlight/Flash LED Driver and Triple LDO Lighting Management Unit

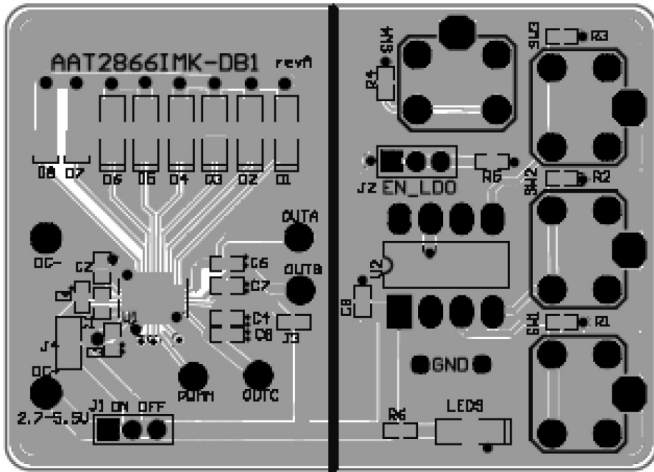

Figure 3: AAT2866 Evaluation Board Top Side Layout.

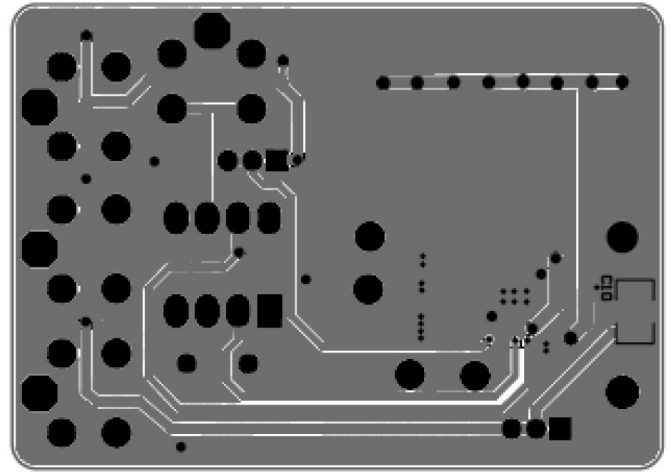

Figure 4: AAT2866 Evaluation Board Bottom Side Layout.

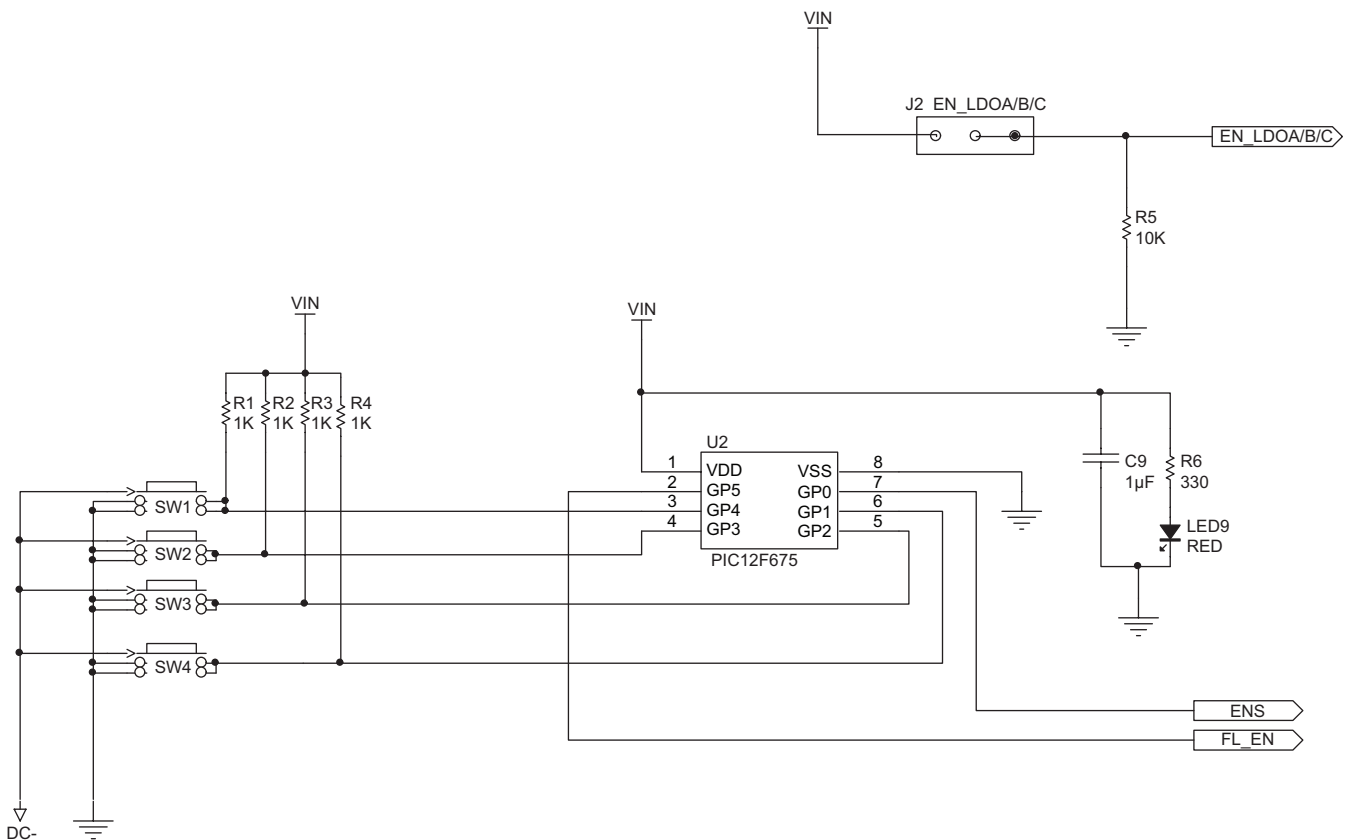

Figure 5: AAT2866 Evaluation Board Microcontroller Schematic.

AAT2866**Backlight/Flash LED Driver and Triple LDO Lighting Management Unit**

Component	Part Number	Description	Manufacturer
U1	AAT2866IMK	Backlight LED driver with 3 LDOs	Skyworks
U2	PIC12F675	8-bit CMOS, FLASH-based μ C; 8-pin PDIP package	Microchip
SW1 – SW4	PTS645TL50	Switch Tact, SPST, 5mm	ITT Industries
R1, R2, R3, R4	Chip Resistor	1k Ω , 5%, 1/4W; 0603	Vishay
R5	Chip Resistor	10k Ω , 5%, 1/4W; 0603	Vishay
R6	Chip Resistor	330 Ω , 5%, 1/4W; 0603	Vishay
C3, C6, C7, C8	GRM188R71A225KE15	2.2 μ F, 10V, X7R, 0603	MuRata
C1, C2, C9	GRM216R61A105KA01	1 μ F, 10V, X5R, 0603	MuRata
C4, C5	GRM18x	4.7 μ F, 10V, X5R, 0603	MuRata
D1-D6	LW M673	Mini TOPLED White LED; SMT	OSRAM
D7, D8	LXCL PWF3	Mini TOPLED Flash LED; SMT	Lumileds, Philips
LED9	CMD15-21SRC/TR8	Red LED; 1206	Chicago Miniature Lamp
J1, J2	PRPN401PAEN	Conn. Header, 2mm zip	Sullins Electronics
J3	Chip Resistor	0 Ω , 5%, 1/4W; 0603	Vishay
J4	Chip resistor	0 Ω , 5%, 1/2W; 0805	Vishay

Table 15: AAT2866 Evaluation Board Bill of Materials (BOM).

AAT2866

Backlight/Flash LED Driver and Triple LDO Lighting Management Unit

Ordering Information

Package	Part Marking ¹	Part Number (Tape and Reel) ²
TQFN34-24	7GXY	AAT2866IMK-T1
TQFN34-24	9JXY	AAT2866IMK-3-T1

 Skyworks Green™ products are compliant with all applicable legislation and are halogen-free. For additional information, refer to Skyworks Definition of Green™, document number SQ04-0074.

Package Information

TQFN34-24³

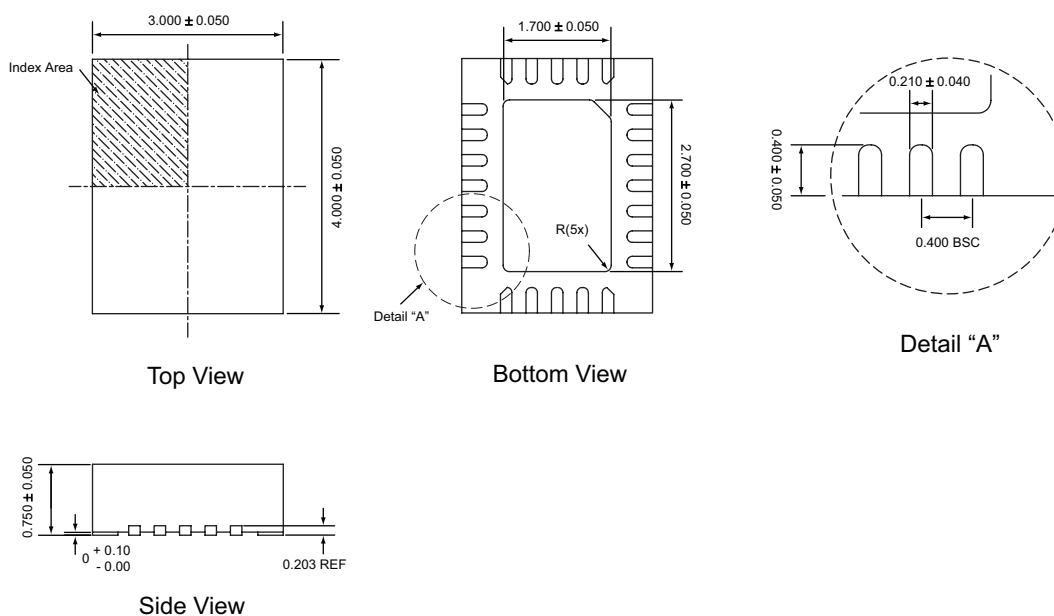

All dimensions in millimeters.

1. XYY = assembly and date code.
 2. Sample stock is generally held on part numbers listed in **BOLD**.
 3. The leadless package family, which includes QFN, TQFN, DFN, TDFN, and STDFN, has exposed copper (unplated) at the end of the lead terminals due to the manufacturing process. A solder fillet at the exposed copper edge cannot be guaranteed and is not required to ensure a proper bottom solder connection.

Backlight/Flash LED Driver and Triple LDO Lighting Management Unit

Copyright © 2012 Skyworks Solutions, Inc. All Rights Reserved.

Information in this document is provided in connection with Skyworks Solutions, Inc. ("Skyworks") products or services. These materials, including the information contained herein, are provided by Skyworks as a service to its customers and may be used for informational purposes only by the customer. Skyworks assumes no responsibility for errors or omissions in these materials or the information contained herein. Skyworks may change its documentation, products, services, specifications or product descriptions at any time, without notice. Skyworks makes no commitment to update the materials or information and shall have no responsibility whatsoever for conflicts, incompatibilities, or other difficulties arising from any future changes.

No license, whether express, implied, by estoppel or otherwise, is granted to any intellectual property rights by this document. Skyworks assumes no liability for any materials, products or information provided hereunder, including the sale, distribution, reproduction or use of Skyworks products, information or materials, except as may be provided in Skyworks Terms and Conditions of Sale.

THE MATERIALS, PRODUCTS AND INFORMATION ARE PROVIDED "AS IS" WITHOUT WARRANTY OF ANY KIND, WHETHER EXPRESS, IMPLIED, STATUTORY, OR OTHERWISE, INCLUDING FITNESS FOR A PARTICULAR PURPOSE OR USE, MERCHANTABILITY, PERFORMANCE, QUALITY OR NON-INFRINGEMENT OF ANY INTELLECTUAL PROPERTY RIGHT; ALL SUCH WARRANTIES ARE HEREBY EXPRESSLY DISCLAIMED. SKYWORKS DOES NOT WARRANT THE ACCURACY OR COMPLETENESS OF THE INFORMATION, TEXT, GRAPHICS OR OTHER ITEMS CONTAINED WITHIN THESE MATERIALS. SKYWORKS SHALL NOT BE LIABLE FOR ANY DAMAGES, INCLUDING BUT NOT LIMITED TO ANY SPECIAL, INDIRECT, INCIDENTAL, STATUTORY, OR CONSEQUENTIAL DAMAGES, INCLUDING WITHOUT LIMITATION, LOST REVENUES OR LOST PROFITS THAT MAY RESULT FROM THE USE OF THE MATERIALS OR INFORMATION, WHETHER OR NOT THE RECIPIENT OF MATERIALS HAS BEEN ADVISED OF THE POSSIBILITY OF SUCH DAMAGE.

Skyworks products are not intended for use in medical, lifesaving or life-sustaining applications, or other equipment in which the failure of the Skyworks products could lead to personal injury, death, physical or environmental damage. Skyworks customers using or selling Skyworks products for use in such applications do so at their own risk and agree to fully indemnify Skyworks for any damages resulting from such improper use or sale.

Customers are responsible for their products and applications using Skyworks products, which may deviate from published specifications as a result of design defects, errors, or operation of products outside of published parameters or design specifications. Customers should include design and operating safeguards to minimize these and other risks. Skyworks assumes no liability for applications assistance, customer product design, or damage to any equipment resulting from the use of Skyworks products outside of stated published specifications or parameters.

Skyworks, the Skyworks symbol, and "Breakthrough Simplicity" are trademarks or registered trademarks of Skyworks Solutions, Inc., in the United States and other countries. Third-party brands and names are for identification purposes only, and are the property of their respective owners. Additional information, including relevant terms and conditions, posted at www.skyworksinc.com, are incorporated by reference.