

Cree® PLCC6 3 in 1 SMD LED CLX6F-GKB

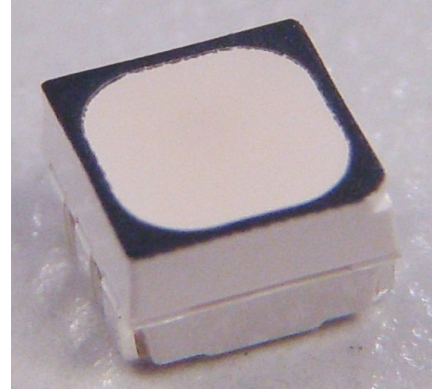

PRODUCT DESCRIPTION

These SMD LEDs are packaged in an industry standard PLCC6 package. These high reliability and high brightness LEDs are designed to work in a wide range of environmental condition and are ideally suited for use in illumination applications.

Its wide viewing angle makes these LEDs ideally suited for channel letter, or general backlighting and illumination applications. The flat top emitting surface makes it easy for these LEDs to mate with light pipes.

FEATURES

- Size (mm): 3.5 x 3.4 x 2.8
- Dominant Wavelength: Green (520 - 540nm)
- Luminous Intensity (mcd) Green (5020-9000)
- Water-Resistant (IPX8)*
- Moisture Sensitivity Level: 5a
- Lead-Free
- RoHS Compliant
- Matte Surface

APPLICATIONS

- Light Strip
- Channel Letter
- Backlight

*:This part is tested under the condition of assembling it on a PCB with isolating the electrical path by silicone.

ABSOLUTE MAXIMUM RATINGS ($T_A = 25^\circ\text{C}$)

| Items | Symbol | Absolute Maximum Rating | Unit |
|--|------------|-------------------------|---------------------------|
| Forward Current ^{Note 1} | I_F | 3 x 35 | mA |
| Peak Forward Current ^{Note 2} | I_{FP} | 3 x 100 | mA |
| Reverse Voltage | V_R | 5 | V |
| Power Dissipation | P_D | 3 x 126 | mW |
| Operation Temperature | T_{opr} | -40 ~ +85 | $^\circ\text{C}$ |
| Storage Temperature | T_{stg} | -40 ~ +100 | $^\circ\text{C}$ |
| Junction Temperature | T_J | 110 | $^\circ\text{C}$ |
| Junction/ambient 1 chip on | R_{THJA} | 400 | $^\circ\text{C}/\text{W}$ |
| Junction/solder point 1 chip on | R_{THJS} | 230 | $^\circ\text{C}/\text{W}$ |
| Electrostatic Discharge Classification(MIL-STD-883E) | ESD | 1000 V | |

Note: 1.Single-color light.
2.Pulse width ≤ 0.1 msec, duty $\leq 1/10$.

TYPICAL ELECTRICAL & OPTICAL CHARACTERISTICS ($T_A = 25^\circ\text{C}$)

| Characteristics | Condition | Symbol | Values | Unit |
|---|------------------------|------------------|---------|---------------|
| Dominant Wavelength | $I_F = 3 \times 20$ mA | λ_{DOM} | 520~540 | nm |
| Spectral bandwidth at 50% I_{REL} max | $I_F = 3 \times 20$ mA | $\Delta \lambda$ | 28 | nm |
| Forward Voltage | $I_F = 3 \times 20$ mA | $V_{F(avg)}$ | 2.9 | V |
| | | $V_{F(max)}$ | 3.6 | V |
| Luminous Intensity | $I_F = 3 \times 20$ mA | $I_{V(min)}$ | 5020 | mcd |
| | | $I_{V(avg)}$ | 7100 | mcd |
| Reverse Current (max) | $V_R = 5$ V | I_R | 10 | μA |

INTENSITY BIN LIMIT ($I_F = 3 \times 20 \text{ mA}$)

Green

| Bin Code | Min.(mcd) | Max.(mcd) |
|----------|-----------|-----------|
| 1h1j | 5020 | 6300 |
| W | 5600 | 7100 |
| 1k1m | 6300 | 8000 |
| X | 7100 | 9000 |

Tolerance of measurement of luminous intensity is $\pm 10\%$.

COLOR BIN LIMIT ($I_F = 3 \times 20 \text{ mA}$)

Green

| Bin Code | Min.(nm) | Max.(nm) |
|----------|----------|----------|
| G7 | 520 | 525 |
| G23 | 522.5 | 527.5 |
| G8 | 525 | 530 |
| G45 | 527.5 | 532.5 |
| G9 | 530 | 535 |
| G67 | 532.5 | 537.5 |
| Ga | 535 | 540 |

Tolerance of measurement of dominant wavelength is $\pm 1 \text{ nm}$.

ORDER CODE TABLE*

| Kit Number | Color | Luminous Intensity (mcd) | | Dominant Wavelength (nm) | | | | Package |
|---------------------|-------|---|------|--------------------------------------|-----------|-----------|-----------|---------|
| | | Min. | Max. | Color Bin | Min. (nm) | Color Bin | Max. (nm) | |
| CLX6F-GKB-C1h1jX7a3 | Green | 5020 | 9000 | G7 | 520 | Ga | 540 | Reel |
| CLX6F-GKB-C1h1j17D3 | Green | Any 1 Intensity bin from 1h1j(5020) - X(9000) | | Any 1 hue bin from G7(520) - Ga(540) | | | | Reel |

Notes:

1. The above kit numbers represent the order codes which include multiple intensity-bin and color-bin codes. Only one intensity-bin code and one color-bin code will be shipped on each reel. Single intensity-bin code and single color-bin code will be orderable in certain quantities. For example, any 1 intensity bin from 1h1j - X means only 1 intensity bin (1h1j or W or 1k1m or X) will be shipped by Cree. For example, any 1 color bin from G7 - Ga means only 1 color bin (G7 or G23 or G8 or G45 or G9 or G67 or Ga) will be shipped by Cree.
2. Please refer to the "Cree LED Lamp Reliability Test Standards" document for reliability test conditions.
3. Please refer to the "Cree LED Lamp Soldering & Handling" document for information about how to use this LED product safely.

GRAPHS

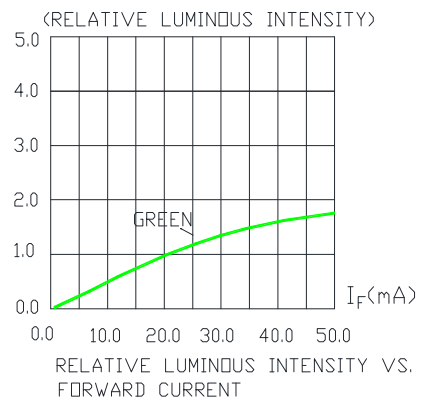
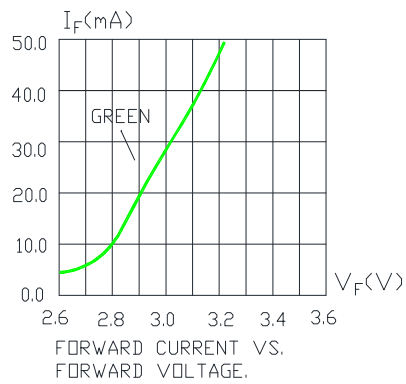
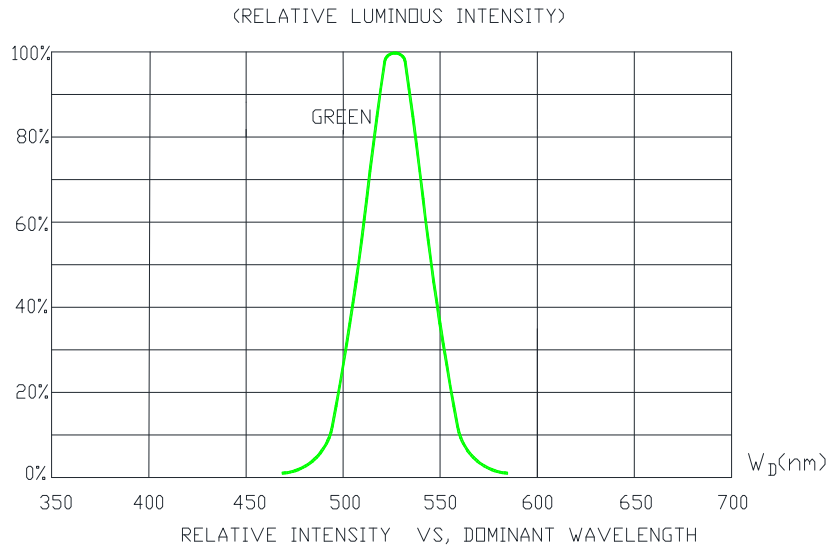

The above data are collected from statistical figures that do not necessarily correspond to the actual parameters of each single LED. Hence, these data will be changed without further notice.

GRAPHS

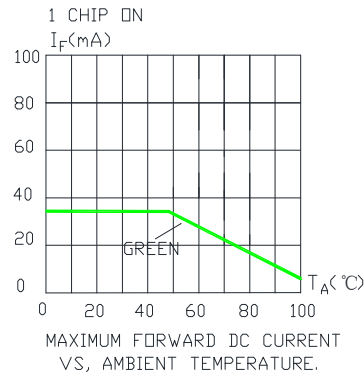
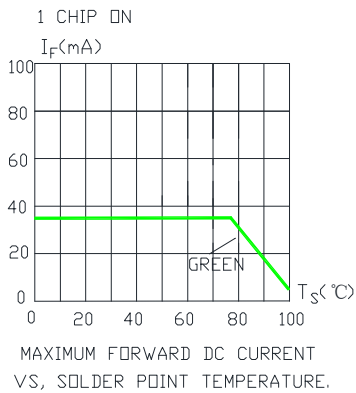
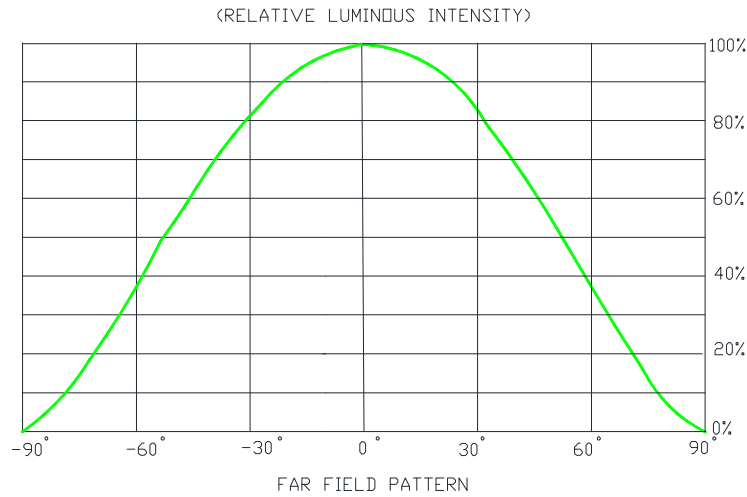

The above data are collected from statistical figures that do not necessarily correspond to the actual parameters of each single LED. Hence, these data will be changed without further notice.

MECHANICAL DIMENSIONS

All dimensions are in mm.

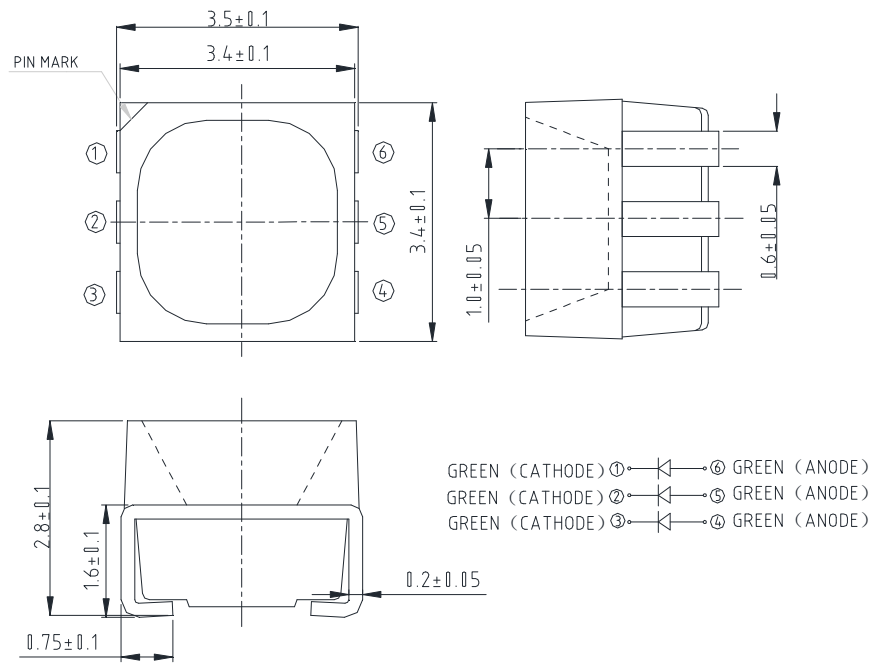

NOTES

RoHS Compliance

The levels of environmentally sensitive, persistent biologically toxic (PBT), persistent organic pollutants (POP), or otherwise restricted materials in this product are below the maximum concentration values (also referred to as the threshold limits) permitted for such substances, or are used in an exempted application, in accordance with EU Directive 2002/95/EC on the restriction of the use of certain hazardous substances in electrical and electronic equipment (RoHS), as amended through April 21, 2006.

Vision Advisory Claim

Users should be cautioned not to stare at the light of this LED product. The bright light can damage the eye.

KIT NUMBER SYSTEM

Cree LED lamps are tested and sorted into performance bins. A bin is specified by ranges of color, forward voltage, and brightness. Sorted LEDs are packaged for shipping in various convenient options. Please refer to the "Cree LED Lamp Packaging Standard" document for more information about shipping and packaging options.

Cree LEDs are sold by order codes in combinations of bins called kits. Order codes are configured in the following manner:

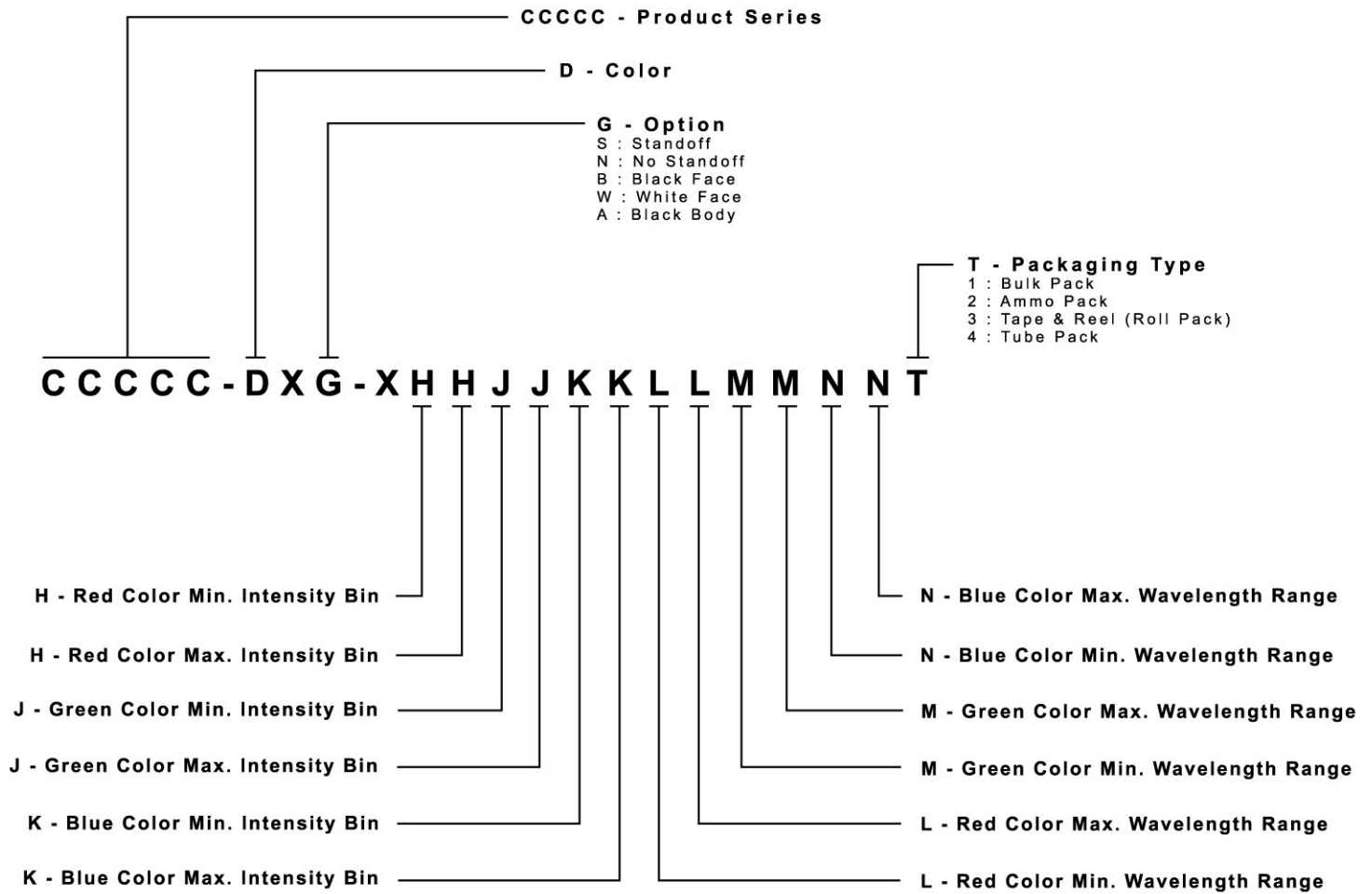

REFLOW SOLDERING

- The CLX6F-GKB is rated as a MSL 5a product.
- The recommended floor life out of bag is 24hrs.
- The best practices suggestion is to bake 24-hour/80°C before use.
- The temperature profile is as below.

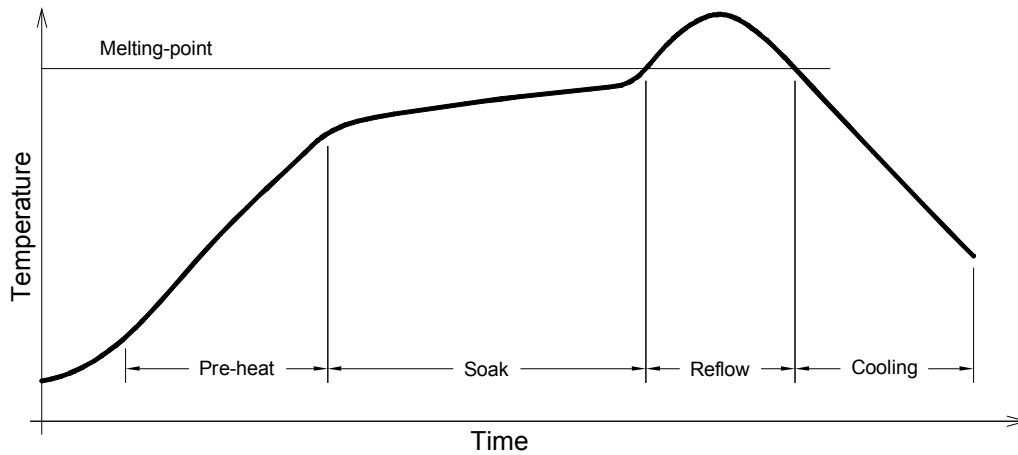

Use only with CLX6F-GKB

| Solder |
|--|
| Average ramp-up rate = 4°C/s max |
| Preheat temperature = 150°C ~200°C |
| Preheat time = 120s max |
| Ramp-down rate = 6°C/s max |
| Peak temperature = 250°C max |
| Time within 5°C of actual Peak Temperature = 10s max |
| Duration above 217°C is 60s max |

PACKAGING

- The boxes are not water resistant and they must be kept away from water and moisture.
- The LEDs are packed in cardboard boxes after packaging in normal or anti-electrostatic bags.
- Cardboard boxes will be used to protect the LEDs from mechanical shocks during transportation.
- The reel pack is applied in SMD LED.
- Max 2800 pcs per reel.

